



**THE DATASHEET OF
BZM55C12-TR3**



Small Signal Zener Diodes



FEATURES

- Saving space
- Hermetic sealed parts
- Electrical data identical with the devices BZT55..series, TZM..series
- Fits onto SOD-323
- Very sharp reverse characteristic
- Low reverse current level
- Very high stability
- Low noise
- AEC-Q101 qualified
- Material categorization: for definitions of compliance please see www.vishay.com/doc?99912



RoHS
COMPLIANT
HALOGEN
FREE

DESIGN SUPPORT TOOLS AVAILABLE



PRIMARY CHARACTERISTICS		
PARAMETER	VALUE	UNIT
V _Z range nom.	2.4 to 75	V
Test current I _{ZT}	2.5; 5	mA
V _Z specification	Pulse current	
Circuit configuration	Single	

APPLICATIONS

- Voltage stabilization

ORDERING INFORMATION			
DEVICE NAME	ORDERING CODE	TAPED UNITS PER REEL	MINIMUM ORDER QUANTITY
BZM55-series	BZM55-series-TR3	10 000 (8 mm tape on 13" reel)	10 000
BZM55-series	BZM55-series-TR	2500 (8 mm tape on 7" reel)	12 500

PACKAGE				
PACKAGE NAME	WEIGHT	MOLDING COMPOUND FLAMMABILITY RATING	MOISTURE SENSITIVITY LEVEL	SOLDERING CONDITIONS
MicroMELF	12 mg	UL 94 V-0	MSL level 1 (according J-STD-020)	Peak temperature max. 260°C

ABSOLUTE MAXIMUM RATINGS (T _{amb} = 25 °C, unless otherwise specified)				
PARAMETER	TEST CONDITION	SYMBOL	VALUE	UNIT
Power dissipation	R _{thJA} ≤ 300 K/W	P _{tot}	500	mW
Junction to ambient air	Mounted on epoxy-glass hard tissue, fig. 1	R _{thJA}	500	K/W
Junction tie point	35 μm copper clad, 0.9 mm ² copper area per electrode	R _{thJL}	300	K/W
Junction temperature		T _j	175	°C
Storage temperature range		T _{stg}	-65 to +175	°C
Zener current		I _Z	P _{tot} /V _Z	mA
Forward voltage	I _F = 200 mA	V _F	1.5	V



ELECTRICAL CHARACTERISTICS ($T_{amb} = 25\text{ }^{\circ}\text{C}$, unless otherwise specified)												
PART NUMBER	ZENER VOLTAGE RANGE ⁽¹⁾			TEST CURRENT		REVERSE LEAKAGE CURRENT			DYNAMIC RESISTANCE		TEMPERATURE COEFFICIENT	
	V_z at I_{ZT1}			I_{ZT1}	I_{ZT2}	I_R at V_R			Z_z at I_{ZT1}	Z_{ZK} at I_{ZT2}	TK_{Vz}	
	V			mA		at $T_{amb} = 25\text{ }^{\circ}\text{C}$		at $T_{amb} = 125\text{ }^{\circ}\text{C}$	f = 1 kHz			
	MIN.	NOM.	MAX.			μA		V	Ω		MIN.	MAX.
BZM55C2V4	2.28	2.4	2.56	5	1	< 50	< 100	1	< 85	< 600	- 0.09	- 0.06
BZM55C2V7	2.5	2.7	2.9	5	1	< 10	< 50	1	< 85	< 600	- 0.09	- 0.06
BZM55C3V0	2.8	3.0	3.2	5	1	< 4	< 40	1	< 90	< 600	- 0.08	- 0.05
BZM55C3V3	3.1	3.3	3.5	5	1	< 2	< 40	1	< 90	< 600	- 0.08	- 0.05
BZM55C3V6	3.4	3.6	3.8	5	1	< 2	< 40	1	< 90	< 600	- 0.08	- 0.05
BZM55C3V9	3.7	3.9	4.1	5	1	< 2	< 40	1	< 90	< 600	- 0.08	- 0.05
BZM55C4V3	4	4.3	4.6	5	1	< 1	< 20	1	< 90	< 600	- 0.06	- 0.03
BZM55C4V7	4.4	4.7	5	5	1	< 0.5	< 10	1	< 80	< 600	- 0.05	0.02
BZM55C5V1	4.8	5.1	5.4	5	1	< 0.1	< 2	1	< 60	< 550	- 0.02	0.02
BZM55C5V6	5.2	5.6	6	5	1	< 0.1	< 2	1	< 40	< 450	- 0.05	0.05
BZM55C6V2	5.8	6.2	6.6	5	1	< 0.1	< 2	2	< 10	< 200	0.03	0.06
BZM55C6V8	6.4	6.8	7.2	5	1	< 0.1	< 2	3	< 8	< 150	0.03	0.07
BZM55C7V5	7	7.5	7.9	5	1	< 0.1	< 2	5	< 7	< 50	0.03	0.07
BZM55C8V2	7.7	8.2	8.7	5	1	< 0.1	< 2	6.2	< 7	< 50	0.03	0.08
BZM55C9V1	8.5	9.1	9.6	5	1	< 0.1	< 2	6.8	< 10	< 50	0.03	0.09
BZM55C10	9.4	10	10.6	5	1	< 0.1	< 2	7.5	< 15	< 70	0.03	0.1
BZM55C11	10.4	11	11.6	5	1	< 0.1	< 2	8.2	< 20	< 70	0.03	0.11
BZM55C12	11.4	12	12.7	5	1	< 0.1	< 2	9.1	< 20	< 90	0.03	0.11
BZM55C13	12.4	13	14.1	5	1	< 0.1	< 2	10	< 26	< 110	0.03	0.11
BZM55C15	13.8	15	15.6	5	1	< 0.1	< 2	11	< 30	< 110	0.03	0.11
BZM55C16	15.3	16	17.1	5	1	< 0.1	< 2	12	< 40	< 170	0.03	0.11
BZM55C18	16.8	18	19.1	5	1	< 0.1	< 2	13	< 50	< 170	0.03	0.11
BZM55C20	18.8	20	21.2	5	1	< 0.1	< 2	15	< 55	< 220	0.03	0.11
BZM55C22	20.8	22	23.3	5	1	< 0.1	< 2	16	< 55	< 220	0.04	0.12
BZM55C24	22.8	24	25.6	5	1	< 0.1	< 2	18	< 80	< 220	0.04	0.12
BZM55C27	25.1	27	28.9	5	1	< 0.1	< 2	20	< 80	< 220	0.04	0.12
BZM55C30	28	30	32	5	1	< 0.1	< 2	22	< 80	< 220	0.04	0.12
BZM55C33	31	33	35	5	1	< 0.1	< 2	24	< 80	< 220	0.04	0.12
BZM55C36	34	36	38	5	1	< 0.1	< 2	27	< 80	< 220	0.04	0.12
BZM55C39	37	39	41	2.5	0.5	< 0.1	< 5	30	< 90	< 500	0.04	0.12
BZM55C43	40	43	46	2.5	0.5	< 0.1	< 5	33	< 90	< 600	0.04	0.12
BZM55C47	44	47	50	2.5	0.5	< 0.1	< 5	36	110	< 700	0.04	0.12
BZM55C51	48	51	54	2.5	0.5	< 0.1	< 10	39	125	< 700	0.04	0.12
BZM55C56	52	56	60	2.5	0.5	< 0.1	< 10	43	135	< 1000	0.04	0.12
BZM55C62	58	62	66	2.5	0.5	< 0.1	< 10	47	150	< 1000	0.04	0.12
BZM55C68	64	68	72	2.5	0.5	< 0.1	< 10	51	200	< 1000	0.04	0.12
BZM55C75	70	75	79	2.5	0.5	< 0.1	< 10	56	250	< 1500	0.04	0.12

Notes

- Additional measurement of voltage group 9V1 to 75 at 95 % $V_{zmin.} \leq 35\text{ nA}$ at $T_j = 25\text{ }^{\circ}\text{C}$
- (1) $t_p \leq 10\text{ ms}$, $T/t_p > 1000$



ELECTRICAL CHARACTERISTICS ($T_{amb} = 25\text{ }^{\circ}\text{C}$, unless otherwise specified)												
PART NUMBER	ZENER VOLTAGE RANGE ⁽¹⁾			TEST CURRENT		REVERSE LEAKAGE CURRENT			DYNAMIC RESISTANCE		TEMPERATURE COEFFICIENT	
	V_z at I_{ZT1}			I_{ZT1}	I_{ZT2}	I_R at V_R			Z_z at I_{ZT1}	Z_{ZK} at I_{ZT2}	TK_{Vz}	
	V			mA		at $T_{amb} = 25\text{ }^{\circ}\text{C}$		at $T_{amb} = 125\text{ }^{\circ}\text{C}$	f = 1 kHz			
	MIN.	NOM.	MAX.			μA		V	Ω	Ω	MIN.	MAX.
BZM55B2V4	2.35	2.4	2.45	5	1	< 50	< 100	1	< 85	< 600	-0.09	-0.06
BZM55B2V7	2.64	2.7	2.76	5	1	< 10	< 50	1	< 85	< 600	-0.09	-0.06
BZM55B3V0	2.94	3.0	3.06	5	1	< 4	< 40	1	< 90	< 600	-0.08	-0.05
BZM55B3V3	3.24	3.3	3.36	5	1	< 2	< 40	1	< 90	< 600	-0.08	-0.05
BZM55B3V6	3.52	3.6	3.68	5	1	< 2	< 40	1	< 90	< 600	-0.08	-0.05
BZM55B3V9	3.82	3.9	3.98	5	1	< 2	< 40	1	< 90	< 600	-0.08	-0.05
BZM55B4V3	4.22	4.3	4.38	5	1	< 1	< 20	1	< 90	< 600	-0.06	-0.03
BZM55B4V7	4.6	4.7	4.8	5	1	< 0.5	< 10	1	< 80	< 600	-0.05	0.02
BZM55B5V1	5	5.1	5.2	5	1	< 0.1	< 2	1	< 60	< 550	-0.02	0.02
BZM55B5V6	5.48	5.6	5.72	5	1	< 0.1	< 2	1	< 40	< 450	-0.05	0.05
BZM55B6V2	6.08	6.2	6.32	5	1	< 0.1	< 2	2	< 10	< 200	0.03	0.06
BZM55B6V8	6.66	6.8	6.94	5	1	< 0.1	< 2	3	< 8	< 150	0.03	0.07
BZM55B7V5	7.35	7.5	7.65	5	1	< 0.1	< 2	5	< 7	< 50	0.03	0.07
BZM55B8V2	8.04	8.2	8.36	5	1	< 0.1	< 2	6.2	< 7	< 50	0.03	0.08
BZM55B9V1	8.92	9.1	9.28	5	1	< 0.1	< 2	6.8	< 10	< 50	0.03	0.09
BZM55B10	9.8	10	10.2	5	1	< 0.1	< 2	7.5	< 15	< 70	0.03	0.1
BZM55B11	10.78	11	11.22	5	1	< 0.1	< 2	8.2	< 20	< 70	0.03	0.11
BZM55B12	11.76	12	12.24	5	1	< 0.1	< 2	9.1	< 20	< 90	0.03	0.11
BZM55B13	12.74	13	13.26	5	1	< 0.1	< 2	10	< 26	< 110	0.03	0.11
BZM55B15	14.7	15	15.3	5	1	< 0.1	< 2	11	< 30	< 110	0.03	0.11
BZM55B16	15.7	16	16.3	5	1	< 0.1	< 2	12	< 40	< 170	0.03	0.11
BZM55B18	17.64	18	18.36	5	1	< 0.1	< 2	13	< 50	< 170	0.03	0.11
BZM55B20	19.6	20	20.4	5	1	< 0.1	< 2	15	< 55	< 220	0.03	0.11
BZM55B22	21.55	22	22.45	5	1	< 0.1	< 2	16	< 55	< 220	0.04	0.12
BZM55B24	23.5	24	24.5	5	1	< 0.1	< 2	18	< 80	< 220	0.04	0.12
BZM55B27	26.4	27	27.6	5	1	< 0.1	< 2	20	< 80	< 220	0.04	0.12
BZM55B30	29.4	30	30.6	5	1	< 0.1	< 2	22	< 80	< 220	0.04	0.12
BZM55B33	32.4	33	33.6	5	1	< 0.1	< 2	24	< 80	< 220	0.04	0.12
BZM55B36	35.3	36	36.7	5	1	< 0.1	< 2	27	< 80	< 220	0.04	0.12
BZM55B39	38.2	39	39.8	2.5	1	< 0.1	< 5	30	< 90	< 500	0.04	0.12
BZM55B43	42.1	43	43.9	2.5	0.5	< 0.1	< 5	33	< 90	< 600	0.04	0.12
BZM55B47	46.1	47	47.9	2.5	0.5	< 0.1	< 5	36	< 110	< 700	0.04	0.12
BZM55B51	50	51	52	2.5	0.5	< 0.1	< 10	39	< 125	< 700	0.04	0.12
BZM55B56	54.9	56	57.1	2.5	0.5	< 0.1	< 10	43	< 135	< 1000	0.04	0.12
BZM55B62	60.8	62	63.2	2.5	0.5	< 0.1	< 10	47	< 150	< 1000	0.04	0.12
BZM55B68	66.6	68	69.4	2.5	0.5	< 0.1	< 10	51	< 200	< 1000	0.04	0.12
BZM55B75	73.5	75	76.5	2.5	0.5	< 0.1	< 10	56	< 250	< 1500	0.04	0.12

Notes

- Additional measurement of voltage group 9V1 to 75 at 95 % $V_{zmin.} \leq 35\text{ nA}$ at $T_j = 25\text{ }^{\circ}\text{C}$
- (1) $t_p \leq 10\text{ ms}$, $T/t_p > 1000$

BASIC CHARACTERISTICS ($T_{amb} = 25\text{ }^{\circ}\text{C}$, unless otherwise specified)

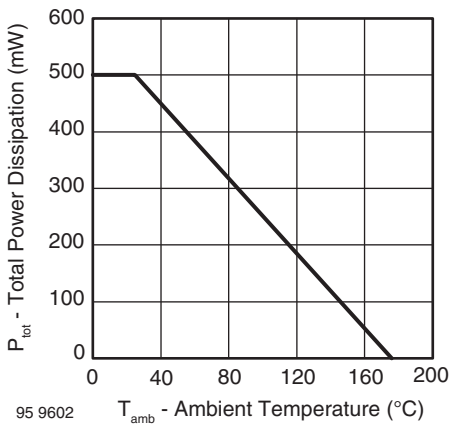

Fig. 1 - Total Power Dissipation vs. Ambient Temperature

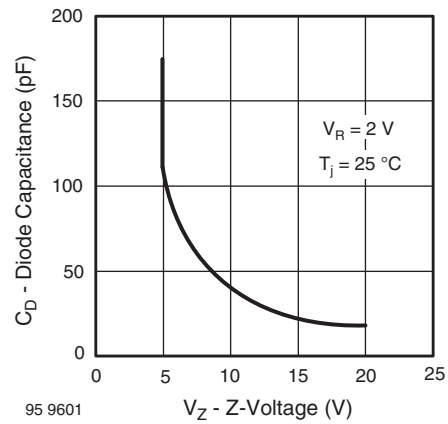

Fig. 4 - Diode Capacitance vs. Z-Voltage

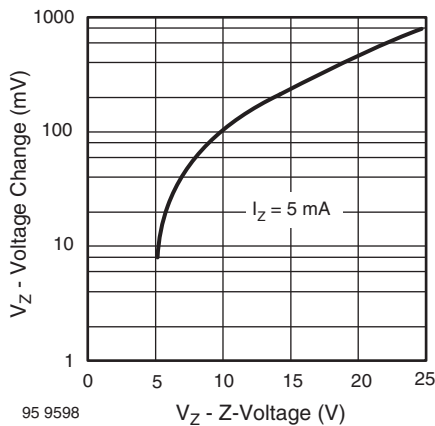

Fig. 2 - Typical Change of Working Voltage under Operating Conditions at $T_{amb}=25\text{ }^{\circ}\text{C}$

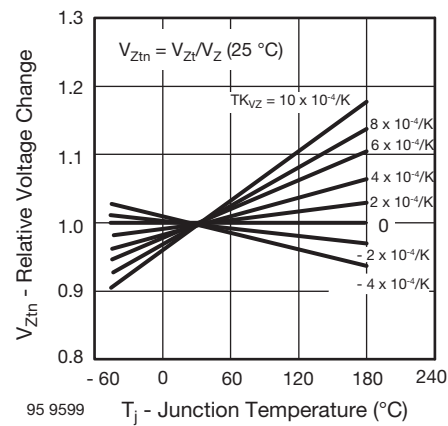

Fig. 5 - Typical Change of Working Voltage vs. Junction Temperature



Fig. 3 - Temperature Coefficient of V_Z vs. Z-Voltage

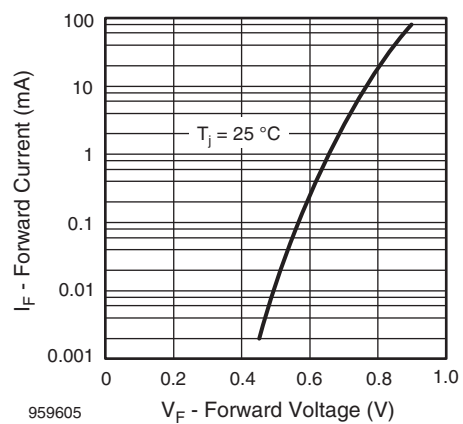

Fig. 6 - Forward Current vs. Forward Voltage



Fig. 7 - Z-Current vs. Z-Voltage



Fig. 10 - Board for R_{thJA} Definition (in mm)



Fig. 8 - Z-Current vs. Z-Voltage



Fig. 11 - Recommended Foot Pads (in mm)



Fig. 9 - Differential Z-Resistance vs. Z-Voltage



Fig. 12 - Recommended Foot Pads (in mm)

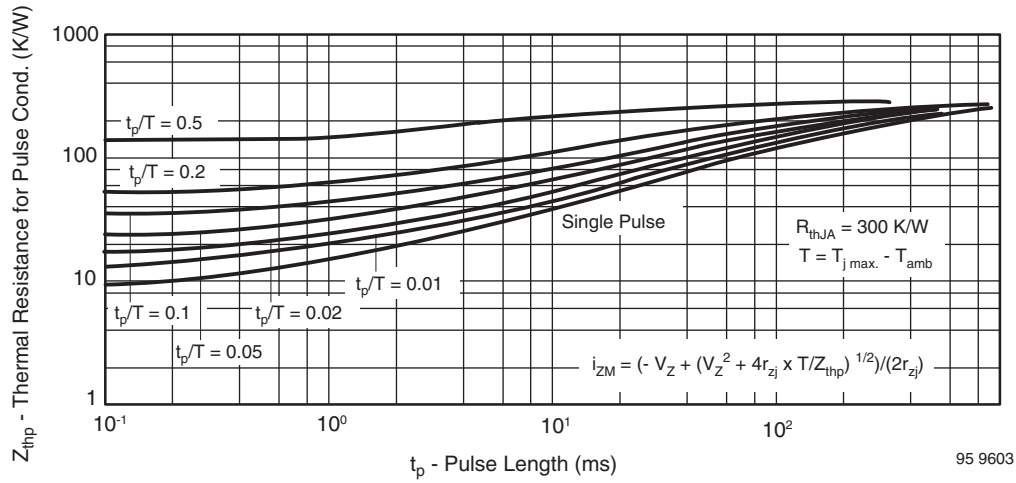
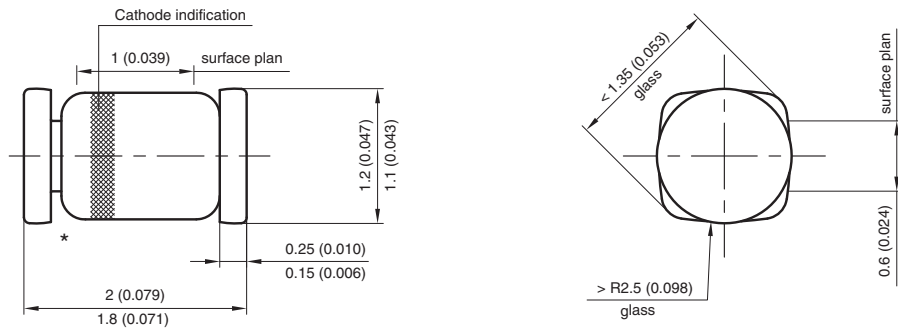

Fig. 13 - Thermal Response

PACKAGE DIMENSIONS in millimeters (inches): **MicromELF (SOD-80)**



* The gap between plug and glass can be either on cathode or anode side

Foot print recommendation:

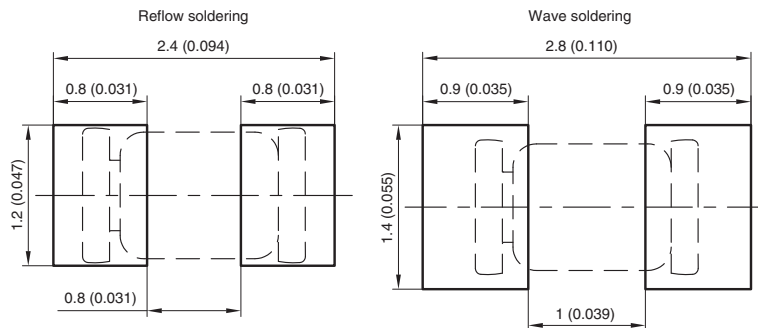

Created - Date: 26.July.1996
Rev. 13 - Date: 07.June.2006
Document no.:6.560-5007.01-4
96 12072



Disclaimer

ALL PRODUCT, PRODUCT SPECIFICATIONS AND DATA ARE SUBJECT TO CHANGE WITHOUT NOTICE TO IMPROVE RELIABILITY, FUNCTION OR DESIGN OR OTHERWISE.

Vishay Intertechnology, Inc., its affiliates, agents, and employees, and all persons acting on its or their behalf (collectively, "Vishay"), disclaim any and all liability for any errors, inaccuracies or incompleteness contained in any datasheet or in any other disclosure relating to any product.

Vishay makes no warranty, representation or guarantee regarding the suitability of the products for any particular purpose or the continuing production of any product. To the maximum extent permitted by applicable law, Vishay disclaims (i) any and all liability arising out of the application or use of any product, (ii) any and all liability, including without limitation special, consequential or incidental damages, and (iii) any and all implied warranties, including warranties of fitness for particular purpose, non-infringement and merchantability.

Statements regarding the suitability of products for certain types of applications are based on Vishay's knowledge of typical requirements that are often placed on Vishay products in generic applications. Such statements are not binding statements about the suitability of products for a particular application. It is the customer's responsibility to validate that a particular product with the properties described in the product specification is suitable for use in a particular application. Parameters provided in datasheets and / or specifications may vary in different applications and performance may vary over time. All operating parameters, including typical parameters, must be validated for each customer application by the customer's technical experts. Product specifications do not expand or otherwise modify Vishay's terms and conditions of purchase, including but not limited to the warranty expressed therein.

Except as expressly indicated in writing, Vishay products are not designed for use in medical, life-saving, or life-sustaining applications or for any other application in which the failure of the Vishay product could result in personal injury or death. Customers using or selling Vishay products not expressly indicated for use in such applications do so at their own risk. Please contact authorized Vishay personnel to obtain written terms and conditions regarding products designed for such applications.

No license, express or implied, by estoppel or otherwise, to any intellectual property rights is granted by this document or by any conduct of Vishay. Product names and markings noted herein may be trademarks of their respective owners.

Looking for pricing, stock, or lifecycle information?

Click below to explore more details on WIN SOURCE:

 [View BZM55C12-TR3 on WIN SOURCE](#)

 [Vishay Information](#)

Optimize Your Supply Chain with WIN SOURCE Solutions

-  Global Sourcing Solution
-  Obsolete Management
-  Cost Control Management
-  Shortage Management
-  Alternative Solution
-  Excess Inventory Management