

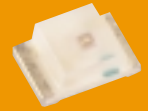

**THE DATASHEET OF
BR1112H-TR**





Features

- Meets industry standards for 2012 (0806) footprint 2.0mm (L) x 1.25mm (W) x 0.8mm (H)
- 1112H is 50% thinner than the W series.

Applications

- Membrane switch panels
- Backlighting
- Cellular telephones

Outline Dimensions

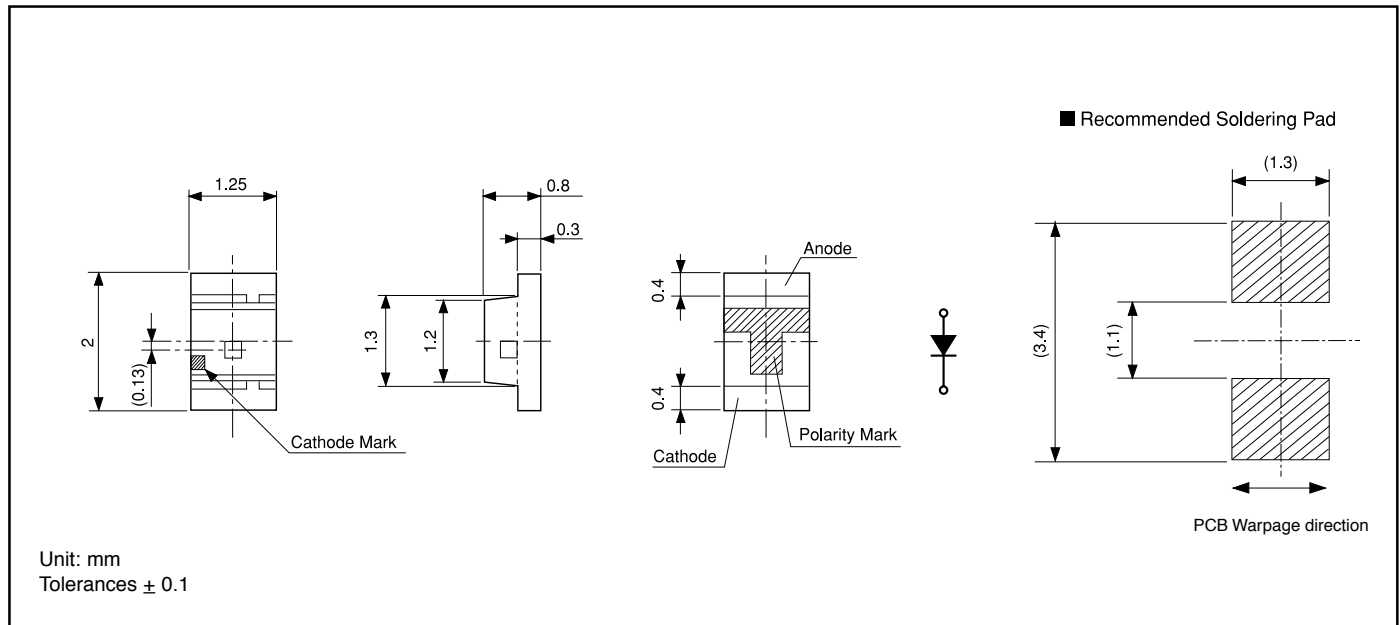

Electro-Optical Characteristics

($T_a=25^\circ\text{C}$)

Type No.	Material	Emitted Color	Lens Color	Luminous Intensity I_V			Wavelength				Forward Voltage V_F			Reverse Current I_R		Viewing Angle ($2\theta 1/2$)
				MIN.	TYP.	I_F	Peak λ_p TYP.	Dominant λ_d TYP.	Spectral Line Half Width $\Delta\lambda$ TYP.	I_F	TYP.	MAX.	I_F	MAX.	V_R	
BR1112H	GaAlAs	Red	Milky White	7.0	11.7	20	660	647	30	20	1.7	2.3	20	100	4	150°
AA1112H	GaAsP	Orange		2.2	3.7	20	605	606	30	20	2.2	2.8	20	100	4	
AY1112H	GaAsP	Yellow		2.2	3.7	20	580	590	30	20	2.2	2.8	20	100	4	
PY1112H	GaP	Yellow-Green		7.0	11.7	20	570	572	30	20	2.1	2.8	20	100	4	
PG1112H	GaP	Green		3.8	6.4	20	560	567	30	20	2.1	2.8	20	100	4	
BG1112H	GaP	Pure Green		1.6	2.7	20	555	558	30	20	2.1	2.8	20	100	4	
Units				mcd		mA	nm			mA	V	mA	μA	V	Deg.	

Absolute Maximum Ratings

(Ta=25°C)

Item	Symbol	Red	Orange	Yellow	Yellow Green	Green	Pure Green	Units
		BR	AA	AY	PY	PG	BG	
Power Dissipation	Pd	57.5	70	70	70	70	70	mW
Forward Current	I _F	25	25	25	25	25	25	mA
Peak Forward Current	I _{FM}	60	60	60	60	60	60	mA
Reverse Voltage	V _R	4	4	4	4	4	4	V
Operating Temperature	Topr	-30 to +85						°C
Storage Temperature	Tstg	-40 to +100						°C
Derating*	ΔI _F	0.36 (DC) 0.86 (Pulse)						mA/°C

* Ta=25°C, I_{FM} applies for the pulse width ≤ 1msec. and duty cycle ≤ 1/20.

Operation Current Derating Chart (DC)

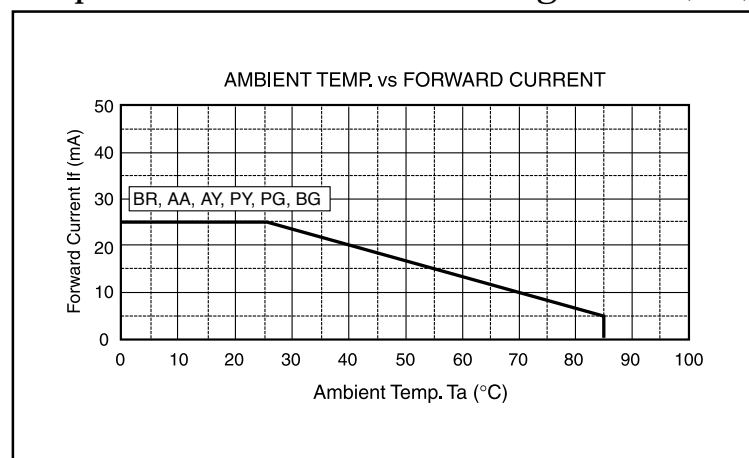

Spatial Distribution

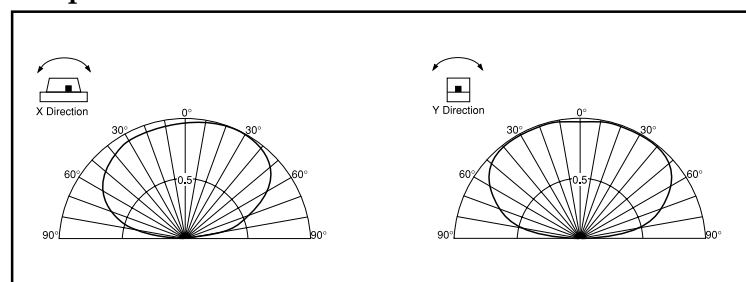

Taping Specifications

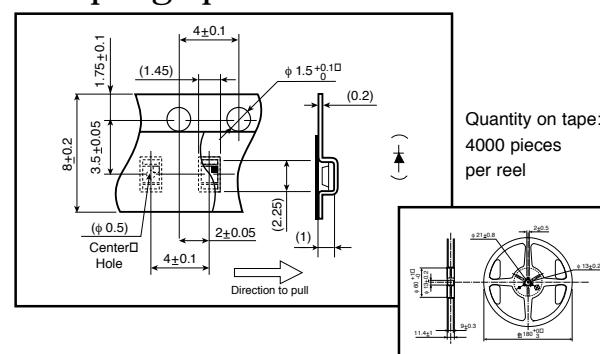

Precautions

Please follow these handling precautions to prevent damage to the chip and ensure its reliability.

1. Soldering conditions:

- **Soldering iron:** Temperature at tip of iron: 280°C max. (30W max.) Soldering time: 3 sec. max.
- **Dip soldering:** Preheating: 120 ~ 150°C max. (resin surface temp.) 60 ~ 120 sec. max. Bath temperature: 260°C max. Dipping Time: 5 sec. max.
- **Reflow Soldering:**

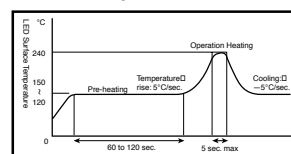



2. Cleaning:

- If cleaning is required, use the following solutions for less than 1 minute, at less than 40°C.
- Appropriate chemicals: Ethyl alcohol and isopropyl alcohol.
- Effect of ultrasonic cleaning on the LED resin body differs depending on such factors as the oscillator output, size of PCB and LED mounting method. The use of ultrasonic cleaning should be enforced at proper output after confirming there is no problem.

Product specifications subject to change without notice. PG1112H-0301

Looking for pricing, stock, or lifecycle information?

Click below to explore more details on WIN SOURCE:

-  [View BR1112H-TR on WIN SOURCE](#)
-  [Stanley Electric Co Information](#)

Optimize Your Supply Chain with WIN SOURCE Solutions

-  Global Sourcing Solution
-  Obsolete Management
-  Cost Control Management
-  Shortage Management
-  Alternative Solution
-  Excess Inventory Management