



**THE DATASHEET OF
SZ1SMA33CAT3G**



SZ1SMA Series



Agency Approvals

Agency	Agency File Number
	E128662

Maximum Ratings and Thermal Characteristics

Parameter	Symbol	Value	Unit
Peak Power Dissipation (Note 1) @ $T_L = 25^\circ\text{C}$, Pulse Width = 1 ms	P_{PK}	400	W
DC Power Dissipation @ $T_L = 75^\circ\text{C}$ Measured Zero Lead Length (Note 2) Derate Above 75°C Thermal Resistance from Junction-to-Lead	P_D	1.5	W
	$R_{\theta JL}$	20	$\text{mW}/^\circ\text{C}$
DC Power Dissipation (Note 3) @ $T_A = 25^\circ\text{C}$ Derate Above 25°C Thermal Resistance from Junction-to-Ambient	P_D	0.5	W
	$R_{\theta JA}$	4.0	$\text{mW}/^\circ\text{C}$
Forward Surge Current (Note 4) @ $T_A = 25^\circ\text{C}$ (for uni-directional)	I_{FSM}	40	A
Operating and Storage Temperature Range	T_J T_{stg}	-65 to +150	$^\circ\text{C}$

Stresses exceeding those listed in the Maximum Ratings table may damage the device. If any of these limits are exceeded, device functionality should not be assumed, damage may occur and reliability may be affected.

- 10 X 1000 μs , non-repetitive.
- 1" square copper pad, FR-4 board.
- FR-4 board, using Littelfuse minimum recommended footprint
- 1/2 sine wave (or equivalent square wave), PW = 8.3 ms, duty cycle = 4 pulses per minute maximum. (for uni-directional)

Description

The SZ1SMA series is designed to protect voltage sensitive components from high voltage, high energy transients. They have excellent clamping capability, high surge capability, low zener impedance and fast response time. The SZ1SMA series is supplied in the Littelfuse exclusive, cost-effective, highly reliable package and is ideally suited for use in communication systems, automotive, numerical controls, process controls, medical equipment, business machines, power supplies and many other industrial and consumer applications.

Features

- Zener Transient Overvoltage Suppressors
- Working Peak Reverse Voltage Range -5V to 170V for uni-directional and 10 V to 78 V for bi-directional
- Standard Zener Breakdown Voltage Range -11.1 V to 95.83 V for bi-directional, 6.4 V to 209 V for uni-directional
- Peak Power – 400 W @ 1 ms
- ESD Rating of Class 3 (> 16 kV) per Human Body Model
- Response Time is Typically < 1 ns
- Flat Handling Surface for Accurate Placement
- Package Design for Top Slide or Bottom Circuit Board Mounting
- Low Profile Package
- Pb-free means 2nd level interconnect is Pb-free and the terminal finish material is tin(Sn) (IPC/JEDEC J-STD-609A.01)
- SZ Prefix for Automotive and Other Applications Requiring Unique Site and Control Change Requirements; AEC-Q101 Qualified and PPAP Capable
- Recognized to UL 497B as an Isolated Loop Circuit Protector
- RoHS-compliant and halogen-free

Additional Information



[Datasheet](#)



[Resources](#)



[Samples](#)

Functional Diagram

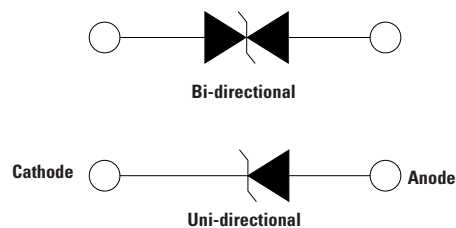

I-V Curve Characteristics ($T_A = 25^\circ\text{C}$ unless otherwise noted) – For Bi-directional

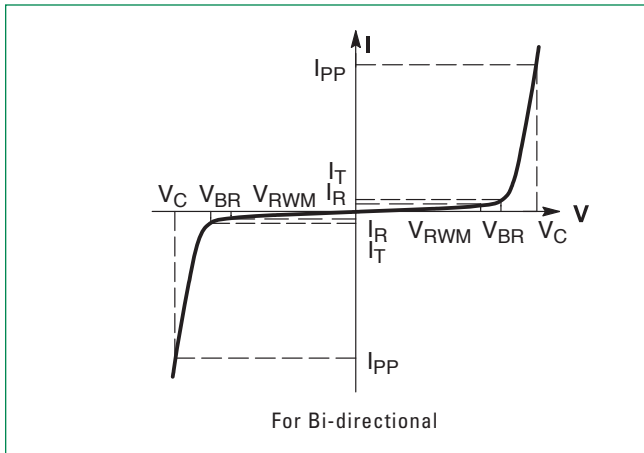

Symbol	Parameter
I_{PP}	Maximum Reverse Peak Pulse Current
V_C	Clamping Voltage @ I_{PP}
V_{RWM}	Working Peak Reverse Voltage
I_R	Maximum Reverse Leakage Current @ V_{RWM}
V_{BR}	Breakdown Voltage @ I_T
I_T	Test Current

I-V Curve Characteristics ($T_A = 25^\circ\text{C}$ unless otherwise noted, $V_F = 3.5\text{ V Max.}$ @ $I_F = 30\text{ A}$ for all types) (Note 5) – For Uni-directional

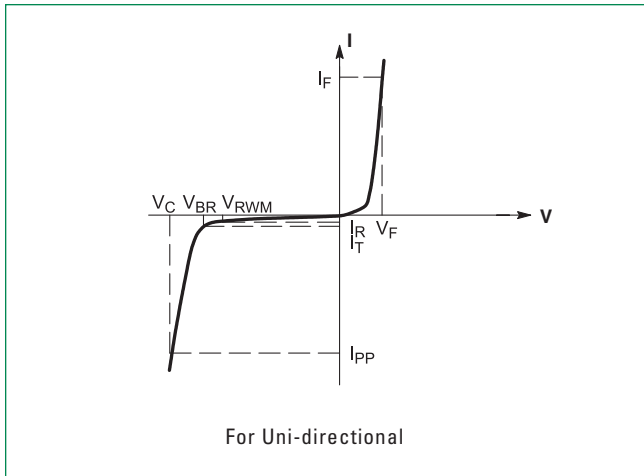

Symbol	Parameter
I_{PP}	Maximum Reverse Peak Pulse Current
V_C	Clamping Voltage @ I_{PP}
V_{RWM}	Working Peak Reverse Voltage
I_R	Maximum Reverse Leakage Current @ V_{RWM}
V_{BR}	Breakdown Voltage @ I_T
I_T	Test Current
I_F	Forward Current
V_F	Forward Voltage @ I_F

5. 1/2 sine wave or equivalent, PW = 8.3 ms, non-repetitive duty cycle.

Electrical Characteristics – For Uni-directional

Device	Device Marking	V _{RWM} ^{Note 6}	I _R @ V _{RWM}	Breakdown Voltage				V _C @ I _{PP} ^{Note 8}		C Typ. ^{Note 9}	Agency Approval 
				V _{BR} @ I _T (V) ^{Note 7}			@ I _T	V _C	I _{PP}		
				MIN	NOM	MAX	mA	Volts	Amps		
SZ1SMA5.0AT3G	QE	5.0	400	6.40	6.70	7.00	10	9.2	43.5	2035	X
SZ1SMA6.0AT3G	QG	6.0	400	6.67	7.02	7.37	10	10.3	38.8	1730	X
SZ1SMA6.5AT3G	QK	6.5	250	7.22	7.60	7.98	10	11.2	35.7	1605	X
SZ1SMA8.0AT3G	QR	8.0	25	8.89	9.36	9.83	1	13.6	29.4	1035	X
SZ1SMA8.5AT3G	QT	8.5	5.0	9.44	9.92	10.40	1	14.4	27.8	1265	X
SZ1SMA9.0AT3G	QV	9.0	2.5	10.00	10.55	11.10	1	15.4	26.0	1200	X
SZ1SMA10AT3G	QX	10	2.5	11.10	11.70	12.30	1	17.0	23.5	1090	X
SZ1SMA11AT3G	QZ	11	2.5	12.20	12.85	13.50	1	18.2	22.0	1000	X
SZ1SMA12AT3G	RE	12	2.5	13.30	14.00	14.70	1	19.9	20.1	925	X
SZ1SMA13AT3G	RG	13	2.5	14.40	15.15	15.90	1	21.5	18.6	860	X
SZ1SMA14AT3G	RH	14	2.5	15.60	16.40	17.20	1	23.2	17.2	800	X
SZ1SMA15AT3G	RM	15	2.5	16.70	17.60	18.50	1	24.4	16.4	758	X
SZ1SMA16AT3G	RP	16	2.5	17.80	18.75	19.70	1	26.0	15.4	715	X
SZ1SMA17AT3G	RR	17	2.5	18.90	19.90	20.90	1	27.6	14.5	680	X
SZ1SMA18AT3G	RT	18	2.5	20.00	21.05	22.10	1	29.2	13.7	645	X
SZ1SMA20AT3G	RV	20	2.5	22.20	23.35	24.50	1	32.4	12.3	585	X
SZ1SMA22AT3G	RX	22	2.5	24.40	25.65	26.90	1	35.5	11.3	540	X
SZ1SMA24AT3G	RZ	24	2.5	26.70	28.10	29.50	1	38.9	10.3	500	X
SZ1SMA26AT3G	SE	26	2.5	28.90	30.40	31.90	1	42.1	9.5	460	X
SZ1SMA28AT3G	SG	28	2.5	31.10	32.75	34.40	1	45.4	8.8	430	X
SZ1SMA30AT3G	SK	30	1.0	33.30	35.05	36.80	1	48.4	8.3	405	X
SZ1SMA33AT3G	SM	33	2.5	36.70	38.65	40.60	1	53.3	7.5	375	X
SZ1SMA36AT3G	SP	36	2.5	40.00	42.10	44.20	1	58.1	6.9	345	X
SZ1SMA40AT3G	SR	40	2.5	44.40	46.75	49.10	1	64.5	6.2	315	X
SZ1SMA43AT3G	ST	43	2.5	47.80	50.30	52.80	1	69.4	5.8	295	X
SZ1SMA45AT3G	SV	45	2.5	50.00	52.65	55.30	1	72.2	5.5	280	X
SZ1SMA48AT3G	SX	48	2.5	53.30	56.10	58.90	1	77.4	5.2	265	X
SZ1SMA51AT3G	SZ	51	2.5	56.70	59.70	62.70	1	82.4	4.9	252	-
SZ1SMA54AT3G	TE	54	2.5	60.00	63.15	66.30	1	87.1	4.6	240	X
SZ1SMA58AT3G	TG	58	2.5	64.40	67.80	71.50	1	93.6	4.3	225	X
SZ1SMA60AT3G	TK	60	2.5	66.70	70.20	73.72	1	96.8	4.1	219	-
SZ1SMA70AT3G	TP	70	2.5	77.80	81.90	86.00	1	113.0	3.5	190	X
SZ1SMA75AT3G	TR	75	2.5	83.3	87.7	92.1	1	121.0	3.3	180	-
SZ1SMA78AT3G	TT	78	2.5	86.7	91.25	95.8	1	126.0	3.2	178	-
SZ1SMA85AT3G	TV	85	2.5	94.4	99.2	104	1	137.0	2.9	173	-
SZ1SMA90AT3G	TX	90	2.5	100	105.5	111	1	146.0	2.8	169	-
SZ1SMA100AT3G	TZ	100	2.5	111	117	123	1	162.0	2.5	162	-
SZ1SMA110AT3G	VE	110	2.5	122	128.5	135	1	177.0	2.3	155	-
SZ1SMA120AT3G	VG	120	2.5	133	140	147	1	193.0	2.1	148	-
SZ1SMA130AT3G	VK	130	2.5	144	151.5	159	1	209.0	1.9	142	-
SZ1SMA150AT3G	VM	150	2.5	167	176	185	1	243.0	1.7	127	-
SZ1SMA160AT3G	VP	160	2.5	178	187.5	197	1	259.0	1.6	119	-
SZ1SMA170AT3G	VR	170	2.5	189	199	209	1	275.0	1.5	112	-

Electrical Characteristics - For Bi-directional

Device	Device Marking	V _{RWM} ^{Note 6}	I _R @ V _{RWM}	Breakdown Voltage				V _C @ I _{PP} ^{Note 8}		Agency Approval 
				V _{BR} @ I _T (V) ^{Note 7}			@ I _T	V _C	I _{PP}	
				Volts	μA	MIN	NOM	MAX	mA	
SZ1SMA10CAT3G	QXC	10	2.5	11.10	11.69	12.27	1	170	23.5	X
SZ1SMA12CAT3G	REC	12	2.5	13.30	14.00	14.70	1	19.9	20.1	X
SZ1SMA13CAT3G	RGC	13	2.5	14.40	15.16	15.92	1	21.5	18.6	X
SZ1SMA15CAT3G	RMC	15	2.5	16.70	17.58	18.46	1	24.4	16.4	X
SZ1SMA16CAT3G	RPC	16	2.5	17.80	18.74	19.67	1	26.0	15.4	X
SZ1SMA18CAT3G	RTC	18	2.5	20.00	21.06	22.11	1	29.2	13.7	X
SZ1SMA20CAT3G	RVC	20	2.5	22.20	23.37	24.54	1	32.4	12.3	X
SZ1SMA22CAT3G	RXC	22	2.5	24.4	25.65	26.90	1	35.5	11.3	-
SZ1SMA24CAT3G	RZC	24	2.5	26.70	28.11	29.51	1	38.9	10.3	X
SZ1SMA26CAT3G	SEC	26	2.5	28.90	30.42	31.94	1	42.1	9.5	X
SZ1SMA28CAT3G	SGC	28	2.5	31.10	32.74	34.37	1	45.4	8.8	X
SZ1SMA30CAT3G	SKC	30	2.5	33.30	35.06	36.81	1	48.4	8.3	X
SZ1SMA33CAT3G	SMC	33	2.5	36.70	38.63	40.56	1	53.3	7.5	X
SZ1SMA36CAT3G	SPC	36	2.5	40.00	42.11	44.21	1	58.1	6.9	X
SZ1SMA40CAT3G	SRC	40	2.5	44.40	46.74	49.07	1	64.5	6.2	X
SZ1SMA43CAT3G	STC	43	2.5	47.80	50.30	52.80	1	69.4	5.8	-
SZ1SMA45CAT3G	SVC	45	2.5	50.00	52.65	55.30	1	72.2	5.5	-
SZ1SMA48CAT3G	SXC	48	2.5	53.30	56.11	58.91	1	77.4	5.2	X
SZ1SMA58CAT3G	TGC	58	2.5	64.40	67.79	71.18	1	93.6	4.3	X
SZ1SMA60CAT3G	TKC	60	2.5	66.70	70.21	73.72	1	96.8	4.1	X
SZ1SMA70CAT3G	TPC	70	2.5	77.80	81.90	85.99	1	113.0	3.5	X
SZ1SMA78CAT3G	TTC	78	2.5	86.70	91.27	95.83	1	126.0	3.2	X

6. A transient suppressor is normally selected according to the working peak reverse voltage (V_{RWM}), which should be equal to or greater than the DC or continuous peak operating voltage level

7. V_{BR} measured at pulse test current I_T at an ambient temperature of 25°C

8. Surge current waveform per Figure 2 and derate per Figure 3

9. Bias voltage = 0 V, F = 1.0 MHz, T_J = 25°C.

Ratings and Characteristic Curves

Figure 1. Pulse Rating Curve

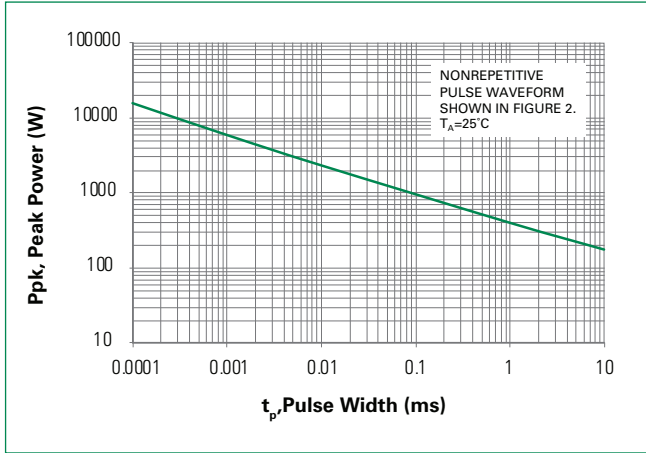

Figure 2. Pulse Waveform



Figure 3 - Surge Derating Curve

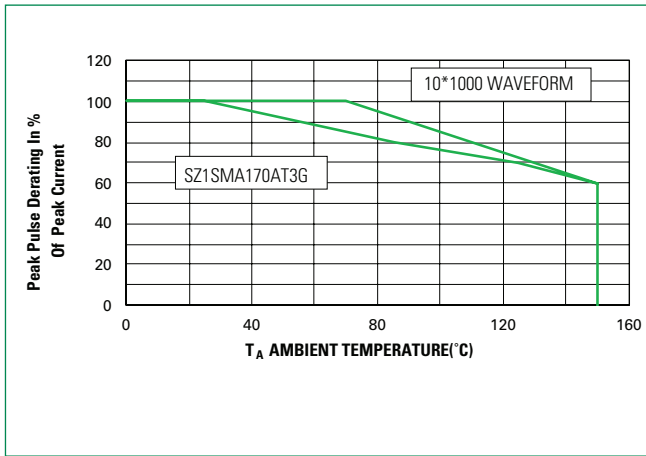

Figure 4. Typical Junction Capacitance vs. Bias Voltage



Figure 5. Typical Junction Capacitance vs. Bias Voltage

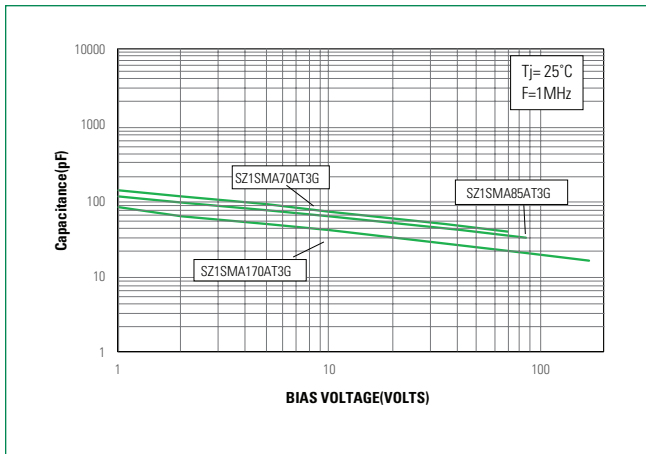
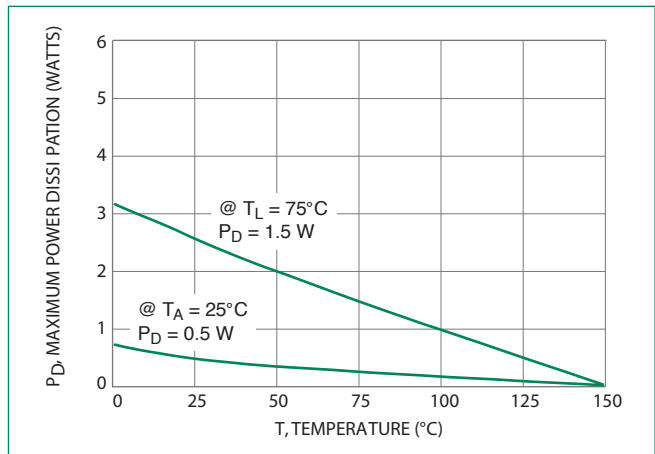

Figure 6. Steady State Power Derating



Soldering Parameters

Reflow Condition		Lead-free assembly
Pre Heat	- Temperature Min ($T_{s(min)}$)	150°C
	- Temperature Max ($T_{s(max)}$)	200°C
	- Time (min to max) (t_g)	60 – 120 secs
Average ramp up rate (Liquidus Temp (T_L) to peak)		3°C/second max
$T_{s(max)}$ to T_L - Ramp-up Rate		3°C/second max
Reflow	- Temperature (T_L) (Liquidus)	217°C
	- Time (min to max) (t_L)	60 – 150 seconds
Peak Temperature (T_p)		260 ^{+0/-5} °C
Time within 5°C of actual peak Temperature (t_p)		30 seconds max
Ramp-down Rate		6°C/second max
Time 25°C to peak Temperature (T_p)		8 minutes max.
Do not exceed		260°C



Physical Specifications

Weight	0.00246 ounce, 0.0767 grams
Case	JEDEC DO214AC. Void-Free, Transfer-Molded, Thermosetting Plastic Epoxy Meets UL 94V-0
Polarity	Color band denotes cathode for unidirectional components.
Terminal	Matte Tin-plated leads, Solderable per JESD22-B102

Environmental Specifications

High Temp. Storage	JESD22-A103
HTRB	JESD22-A108
Temperature Cycling	JESD22-A104
MSL	JEDEC-J-STD-020, Level 1
H3TRB	JESD22-A101
RSH	JESD22-A111

Soldering Footprint



Dimensions

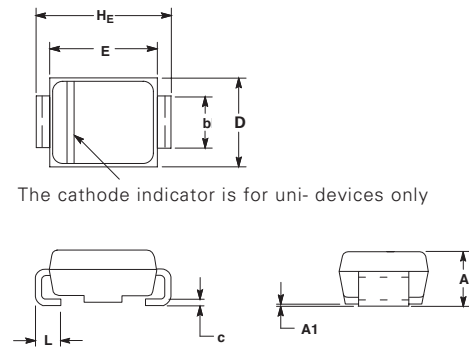

Ordering Information

Device**	Package	Shipping
SZ1SMAxxAT3G	SMA (Pb-Free)	5,000 / Tape & Reel
SZ1SMAxxCAT3G	SMA (Pb-Free)	5,000 / Tape & Reel

**The "T3" suffix refers to a 13 inch reel

Dim	Inches			Millimeters		
	Min	Nom	Max	Min	Nom	Max
A	0.078	0.083	0.087	1.97	2.10	2.20
A1	0.002	0.004	0.008	0.05	0.10	0.20
b	0.050	0.057	0.064	1.27	1.45	1.63
c	0.006	0.011	0.016	0.15	0.28	0.41
D	0.090	0.103	0.115	2.29	2.60	2.92
E	0.160	0.170	0.180	4.06	4.32	4.57
H _E	0.190	0.205	0.220	4.83	5.21	5.59
L	0.030	0.045	0.060	0.76	1.14	1.52

Part Marking System



XXXX = Device Code (max four digits)
 Y = Year
 M = Month
 A = Assembly Location
 WW = Lot Code

Part Numbering System



Tape and Reel Specification



Looking for pricing, stock, or lifecycle information?

Click below to explore more details on WIN SOURCE:

 [View SZ1SMA33CAT3G on WIN SOURCE](#)

 [Littelfuse Inc. Information](#)

Optimize Your Supply Chain with WIN SOURCE Solutions

-  Global Sourcing Solution
-  Obsolete Management
-  Cost Control Management
-  Shortage Management
-  Alternative Solution
-  Excess Inventory Management