



**THE DATASHEET OF
DW1000-I-TR13**



Product Overview

The DW1000 is a fully integrated single chip Ultra Wideband (UWB) low-power low-cost transceiver IC compliant to IEEE802.15.4-2011. It can be used in 2-way ranging or TDoA location systems to locate assets to a precision of 10 cm. It also supports data transfer at rates up to 6.8 Mbps



Key Features

- IEEE802.15.4-2011 UWB compliant
- Supports 6 RF bands from 3.5 GHz to 6.5 GHz
- Programmable transmitter output power
- Fully coherent receiver for maximum range and accuracy
- Complies with FCC & ETSI UWB spectral masks
- Supply voltage 2.8 V to 3.6 V
- Low power consumption
- SLEEP current 1 μ A
- DEEPSLEEP current 50 nA
- Data rates of 110 kbps, 850 kbps, 6.8 Mbps
- Maximum packet length of 1023 bytes for high data throughput applications
- Integrated MAC support features
- Supports TWR and TDOA
- SPI interface to host processor
- 6 mm x 6 mm 48-pin QFN package with 0.4 mm lead pitch
- Small number of external components

Key Benefits

- Supports precision location and data transfer concurrently
- Asset location to a precision of 10 cm
- Extended communications range up to 290 m @ 110 kbps 10% PER minimises required infrastructure in RTLS
- High multipath fading immunity
- Supports high tag densities in RTLS
- Small PCB footprint allows cost-effective hardware implementations
- Long battery life minimises system lifetime cost

Applications

- Precision real time location systems (RTLS) using two-way ranging or TDOA schemes in a variety of markets: -
 - Healthcare
 - Consumer
 - Industrial
 - Other
- Location aware wireless sensor networks

DW1000 IEEE802.15.4-2011 UWB Transceiver

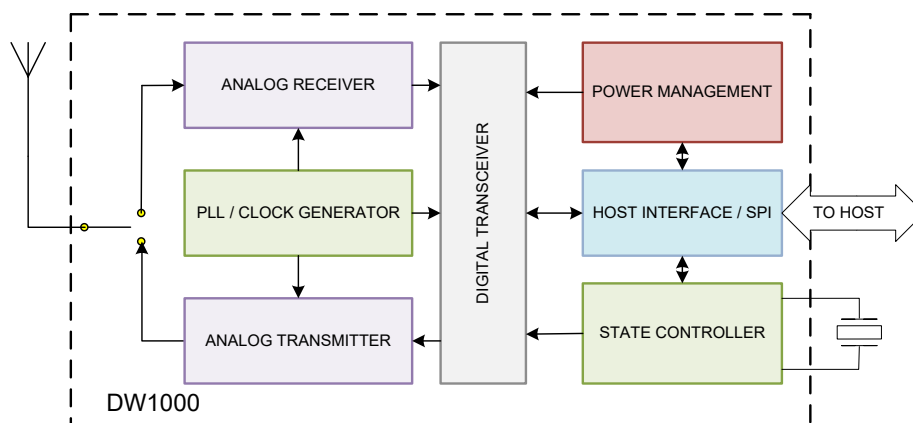

High Level Block Diagram

Table of Contents

1	IC DESCRIPTION	5			
2	PIN CONNECTIONS	6			
2.1	PIN NUMBERING	6			
2.2	PIN DESCRIPTIONS	6			
3	ELECTRICAL SPECIFICATIONS	10			
3.1	NOMINAL OPERATING CONDITIONS	10			
3.2	DC CHARACTERISTICS	10			
3.3	RECEIVER AC CHARACTERISTICS	10			
3.4	RECEIVER SENSITIVITY CHARACTERISTICS	11			
3.5	REFERENCE CLOCK AC CHARACTERISTICS	12			
3.5.1	Reference Frequency	12			
3.6	TRANSMITTER AC CHARACTERISTICS	12			
3.7	TEMPERATURE AND VOLTAGE MONITOR CHARACTERISTICS	13			
3.8	ABSOLUTE MAXIMUM RATINGS	13			
4	TYPICAL PERFORMANCE	14			
5	FUNCTIONAL DESCRIPTION	18			
5.1	PHYSICAL LAYER MODES	18			
5.1.1	Supported Channels and Bandwidths	18			
5.1.2	Supported Bit Rates and Pulse Repetition Frequencies (PRF)	18			
5.1.3	Frame Format	19			
5.1.4	Symbol Timings	19			
5.1.5	Proprietary Long Frames	19			
5.1.6	Turnaround Times	19			
5.1.7	Frame Filter	20			
5.1.8	Frame Check Sequence (FCS)	20			
5.2	REFERENCE CRYSTAL OSCILLATOR	20			
5.3	SYNTHESIZER	20			
5.4	RECEIVER	20			
5.4.1	Bandwidth setting	20			
5.4.2	Automatic Gain Control (AGC)	20			
5.5	TRANSMITTER	20			
5.5.1	Transmit Output Power	20			
5.5.2	Transmit Bandwidth Setting	21			
5.6	POWER-UP SEQUENCE	22			
5.6.1	Typical power-up sequence	22			
5.6.2	Variation in the power-up sequence	22			
5.6.3	External control of RSTn / use of RSTn by external circuitry	23			
5.7	VOLTAGE/TEMPERATURE MONITORS	23			
5.8	HOST CONTROLLER INTERFACE	23			
5.8.1	Configuring the SPI Mode	25			
5.8.2	SPI Signal Timing	26			
5.9	GENERAL PURPOSE INPUT OUTPUT (GPIO)	27			
5.10	MEMORY	27			
5.10.1	Receive and Transmit data buffers	27			
5.10.2	Accumulator memory	27			
5.10.3	One Time Programmable (OTP) Calibration Memory	28			
5.11	INTERRUPTS AND DEVICE STATUS	28			
5.12	MAC FEATURES	28			
5.12.1	Timestamping	28			
5.12.2	FCS Generation and Checking	28			
5.12.3	Automatic Frame Filtering	28			
5.12.4	Automatic Acknowledge	28			
5.12.5	Double Receive Buffer	28			
5.13	EXTERNAL SYNCHRONIZATION	28			
5.14	CALIBRATION AND SPECTRAL TUNING OF THE DW1000 29				
5.14.1	Introduction	29			
5.14.2	Crystal Oscillator Trim	29			
5.14.3	Transmitter Calibration	30			
5.14.4	Antenna Delay Calibration	30			
6	OPERATIONAL STATES AND POWER MANAGEMENT	31			
6.1	OVERVIEW	31			
6.2	OPERATING STATES AND THEIR EFFECT ON POWER CONSUMPTION	31			
6.3	TRANSMIT AND RECEIVE POWER PROFILES	32			
6.3.1	Typical transmit profile	35			
6.3.2	Typical receive profiles	35			
7	POWER SUPPLY	36			
7.1	POWER SUPPLY CONNECTIONS	36			
7.2	USE OF EXTERNAL DC / DC CONVERTER	36			
7.3	POWERING DOWN THE DW1000	37			
8	APPLICATION INFORMATION	38			
8.1	APPLICATION CIRCUIT DIAGRAM	38			
8.2	RECOMMENDED COMPONENTS	39			
8.3	APPLICATION CIRCUIT LAYOUT	40			
8.3.1	PCB Stack	40			
8.3.2	RF Traces	41			
8.3.3	PLL Loop Filter Layout	41			
8.3.4	Decoupling Layout	41			
8.3.5	Layout Guidance	41			
9	PACKAGING & ORDERING INFORMATION	42			
9.1	PACKAGE DIMENSIONS	42			
9.2	DEVICE PACKAGE MARKING	43			
9.3	TRAY INFORMATION	43			
9.4	TAPE & REEL INFORMATION	44			
9.4.1	Important note	44			
9.4.2	Tape Orientation and Dimensions ...	44			
9.4.3	Reel Information: 330 mm Reel	45			
9.5	REFLOW PROFILE	45			
9.6	ORDERING INFORMATION	46			
10	GLOSSARY	47			
11	REFERENCES	48			
12	DOCUMENT HISTORY	48			
13	MAJOR CHANGES	49			
14	FURTHER INFORMATION	53			

List of Figures

FIGURE 1: IC BLOCK DIAGRAM.....	5	CANNOT BE GUARANTEED TO BE READY IN TIME FOR THE RSTN GOING HIGH	22
FIGURE 2: DW1000 PIN ASSIGNMENTS.....	6	FIGURE 22: DW1000 SPIPHA=0 TRANSFER PROTOCOL	24
FIGURE 3 : RX INTERFERER IMMUNITY ON CHANNEL 2.....	14	FIGURE 23: DW1000SPIPHA=1 TRANSFER PROTOCOL.	24
FIGURE 4: TX OUTPUT POWER OVER TEMP & VOLTAGE... ..	14	FIGURE 24: SPI BYTE FORMATTING.....	24
FIGURE 5: RECEIVER SENSITIVITY CHANNEL 5 110KBPS DATA RATE 16 MHZ PRF 2048 PREAMBLE SYMBOLS.....	14	FIGURE 25: SPI CONNECTIONS.....	25
FIGURE 6: RECEIVER SENSITIVITY CHANNEL 5 110KBPS DATA RATE 64 MHZ PRF 2048 PREAMBLE SYMBOLS.....	15	FIGURE 26: DW1000 SPI TIMING DIAGRAM	26
FIGURE 7: RECEIVER SENSITIVITY CHANNEL 5 850KBPS DATA RATE 16 MHZ PRF 1024 PREAMBLE SYMBOLS.....	15	FIGURE 27: DW1000 SPI DETAILED TIMING DIAGRAM..	26
FIGURE 8: RECEIVER SENSITIVITY CHANNEL 5 850KBPS DATA RATE 64 MHZ PRF 1024 PREAMBLE SYMBOLS.....	15	FIGURE 28: SYNC SIGNAL TIMING RELATIVE TO XTAL1....	29
FIGURE 9: RECEIVER SENSITIVITY CHANNEL 5 6.81Mbps DATA RATE 16 MHZ PRF 256 PREAMBLE SYMBOLS 16		FIGURE 29: TYPICAL DEVICE CRYSTAL TRIM PPM ADJUSTMENT	30
FIGURE 10: RECEIVER SENSITIVITY CHANNEL 5 6.81Mbps DATA RATE 64 MHZ PRF 1256 PREAMBLE SYMBOLS	16	FIGURE 30: SLEEP OPTIONS BETWEEN OPERATIONS	32
FIGURE 11: TYPICAL PROBABILITY DISTRIBUTION OF LINE OF SIGHT 2-WAY RANGING PERFORMANCE.....	16	FIGURE 31: TYPICAL RANGE VERSUS TX AVERAGE CURRENT (CHANNEL 2).....	34
FIGURE 12: TX SPECTRUM CHANNEL 1.....	17	FIGURE 32: TYPICAL TX POWER PROFILE.....	35
FIGURE 13: TX SPECTRUM CHANNEL 2.....	17	FIGURE 33: TYPICAL RX POWER PROFILE	35
FIGURE 14: TX SPECTRUM CHANNEL 3.....	17	FIGURE 34: TYPICAL RX POWER PROFILE USING SNIFF MODE.....	35
FIGURE 15: TX SPECTRUM CHANNEL 4.....	17	FIGURE 35: POWER SUPPLY CONNECTIONS.....	36
FIGURE 16: TX SPECTRUM CHANNEL 5.....	17	FIGURE 36: SWITCHING REGULATOR CONNECTION.....	36
FIGURE 17: TX SPECTRUM CHANNEL 7.....	17	FIGURE 37: DW1000 APPLICATION CIRCUIT.....	38
FIGURE 18: IEEE802.15.4-2011 PDU STRUCTURE ...	19	FIGURE 38: PCB LAYER STACK FOR 4-LAYER BOARD	40
FIGURE 19: IEEE802.15.4-2011 MAC FRAME FORMAT	20	FIGURE 39: DW1000 RF TRACES LAYOUT.....	41
FIGURE 20: DW1000 POWER-UP SEQUENCE.....	22	FIGURE 40: DEVICE PACKAGE MECHANICAL SPECIFICATIONS	42
FIGURE 21: POWER UP EXAMPLE WHERE VDDL DOD		FIGURE 41: DEVICE PACKAGE MARKINGS	43

List of Tables

TABLE 1: DW1000 PIN FUNCTIONS.....	6	TABLE 17: DW1000 SPI MODE CONFIGURATION.....	25
TABLE 2: EXPLANATION OF ABBREVIATIONS.....	9	TABLE 18: DW1000 SPI TIMING PARAMETERS @ A) 125 MHZ SYSTEM CLOCK AND B) 19.2 MHZ SYSTEM CLOCK	26
TABLE 3: DW1000 OPERATING CONDITIONS.....	10	TABLE 19: TRANSMIT & RECEIVE BUFFER MEMORY SIZE..	27
TABLE 4: DW1000 DC CHARACTERISTICS	10	TABLE 20: ACCUMULATOR MEMORY SIZE	28
TABLE 5: DW1000 RECEIVER AC CHARACTERISTICS.....	11	TABLE 21: OTP CALIBRATION MEMORY.....	28
TABLE 6: TYPICAL RECEIVER SENSITIVITY CHARACTERISTICS	11	TABLE 22: SYNC SIGNAL TIMING RELATIVE TO XTAL	29
TABLE 7: DW1000 REFERENCE CLOCK AC CHARACTERISTICS	12	TABLE 23: OPERATING STATES	31
TABLE 8: DW1000 TRANSMITTER AC CHARACTERISTICS.	12	TABLE 24: OPERATING STATES AND THEIR EFFECT ON POWER CONSUMPTION	31
TABLE 9: DW1000 TEMPERATURE AND VOLTAGE MONITOR CHARACTERISTICS	13	TABLE 25: OPERATIONAL MODES	32
TABLE 10: DW1000 ABSOLUTE MAXIMUM RATINGS.....	13	TABLE 26: TYPICAL TX CURRENT CONSUMPTION	33
TABLE 11: CHANNELS SUPPORTED BY THE DW1000.....	18	TABLE 27: TYPICAL RX CURRENT CONSUMPTION	33
TABLE 12: UWB BIT RATES AND PRF MODES SUPPORTED BY THE DW1000	18	TABLE 28: LOWEST POWER AND LONGEST RANGE MODES OF OPERATION.....	34
TABLE 13: DW1000 SYMBOL DURATIONS.....	19	TABLE 29: DEVICE ORDERING INFORMATION	46
TABLE 14: TURN-AROUND TIMES	19	TABLE 30: GLOSSARY OF TERMS	47
TABLE 15: DW1000 POWER-UP TIMINGS.....	22	TABLE 31: DOCUMENT HISTORY	48
TABLE 16: EXTERNAL USE OF RSTN.....	23		

DOCUMENT INFORMATION

Disclaimer

Decawave reserves the right to change product specifications without notice. As far as possible changes to functionality and specifications will be issued in product specific errata sheets or in new versions of this document. Customers are advised to check with Decawave for the most recent updates on this product.

Copyright © 2015 Decawave Ltd

LIFE SUPPORT POLICY

Decawave products are not authorized for use in safety-critical applications (such as life support) where a failure of the Decawave product would reasonably be expected to cause severe personal injury or death. Decawave customers using or selling Decawave products in such a manner do so entirely at their own risk and agree to fully indemnify Decawave and its representatives against any damages arising out of the use of Decawave products in such safety-critical applications.



Caution! ESD sensitive device. Precaution should be used when handling the device in order to prevent permanent damage.

REGULATORY APPROVALS

The DW1000, as supplied from Decawave, has not been certified for use in any particular geographic region by the appropriate regulatory body governing radio emissions in that region although it is capable of such certification depending on the region and the manner in which it is used.

All products developed by the user incorporating the DW1000 must be approved by the relevant authority governing radio emissions in any given jurisdiction prior to the marketing or sale of such products in that jurisdiction and user bears all responsibility for obtaining such approval as needed from the appropriate authorities.

1 IC DESCRIPTION

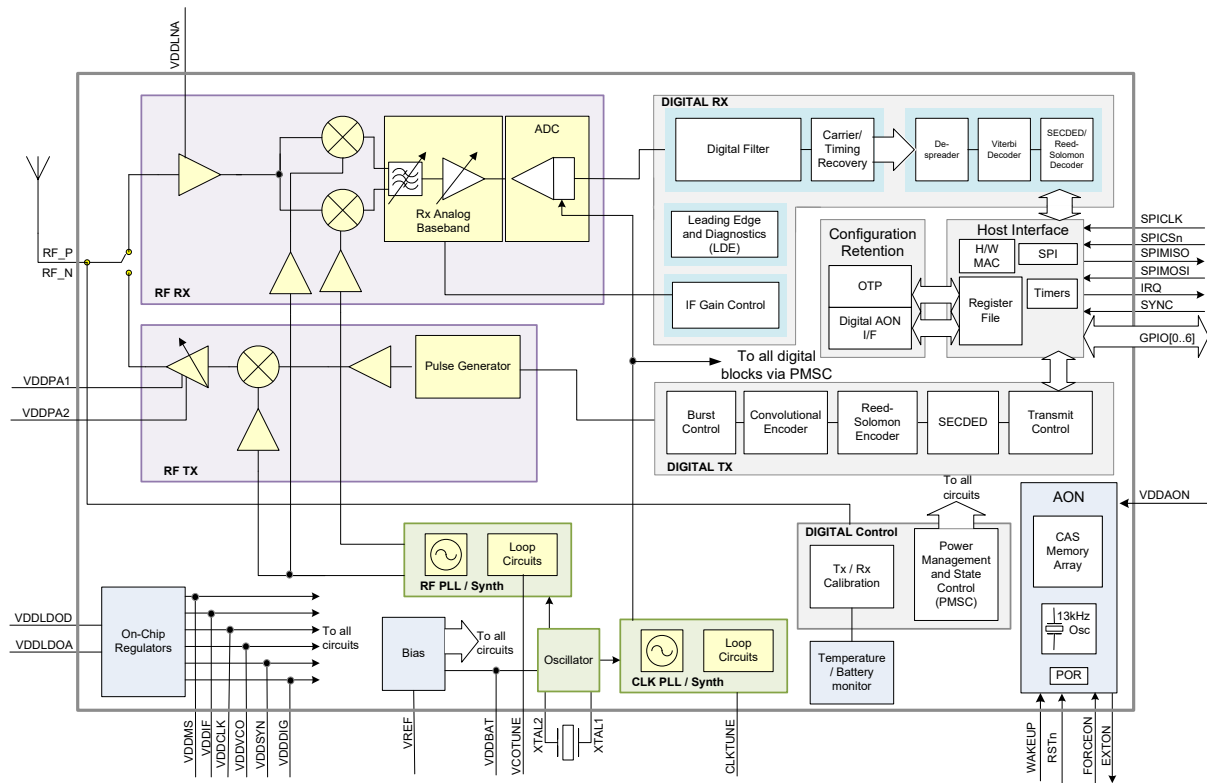

Figure 1: IC Block Diagram

DW1000 is a fully integrated low-power, single chip CMOS RF transceiver IC compliant with the IEEE802.15.4-2011 [1] UWB standard.

DW1000 consists of an analog front end containing a receiver and a transmitter and a digital back end that interfaces to an off-chip host processor. A TX/RX switch is used to connect the receiver or transmitter to the antenna port. Temperature and voltage monitors are provided on-chip

The receiver consists of an RF front end which amplifies the received signal in a low-noise amplifier before down-converting it directly to baseband. The receiver is optimized for wide bandwidth, linearity and noise figure. This allows each of the supported UWB channels to be down converted with minimum additional noise and distortion. The baseband signal is demodulated and the resulting received data is made available to the host controller via SPI.

The transmit pulse train is generated by applying digitally encoded transmit data to the analog pulse generator. The pulse train is up-converted by a double balanced mixer to a carrier generated by the synthesizer and centred on one of the permitted UWB channels. The modulated RF waveform is amplified before transmission from the external antenna.

The IC has an on-chip One-Time Programmable (OTP) memory. This memory can be used to store calibration data such as TX power level, crystal initial

frequency error adjustment, and range accuracy adjustment. These adjustment values can be automatically retrieved when needed. See section 5.14 for more details.

The Always-On (AON) memory can be used to retain DW1000 configuration data during the lowest power operational states when the on-chip voltage regulators are disabled. This data is uploaded and downloaded automatically. Use of DW1000 AON memory is configurable.

The DW1000 clocking scheme is based around 3 main circuits; Crystal Oscillator, Clock PLL and RF PLL. The on-chip oscillator is designed to operate at a frequency of 38.4 MHz using an external crystal. An external 38.4 MHz clock signal may be applied in place of the crystal if an appropriately stable clock is available elsewhere in the user's system. This 38.4 MHz clock is used as the reference clock input to the two on-chip PLLs. The clock PLL (denoted CLKPLL) generates the clock required by the digital back end for signal processing. The RF PLL generates the down-conversion local oscillator (LO) for the receive chain and the up-conversion LO for the transmit chain. An internal 13 kHz oscillator is provided for use in the SLEEP state.

The host interface includes a slave-only SPI for device communications and configuration. A number of MAC features are implemented including CRC generation, CRC checking and receive frame filtering.

2 PIN CONNECTIONS

2.1 Pin Numbering

QFN-48 package with pin assignments as follows: -

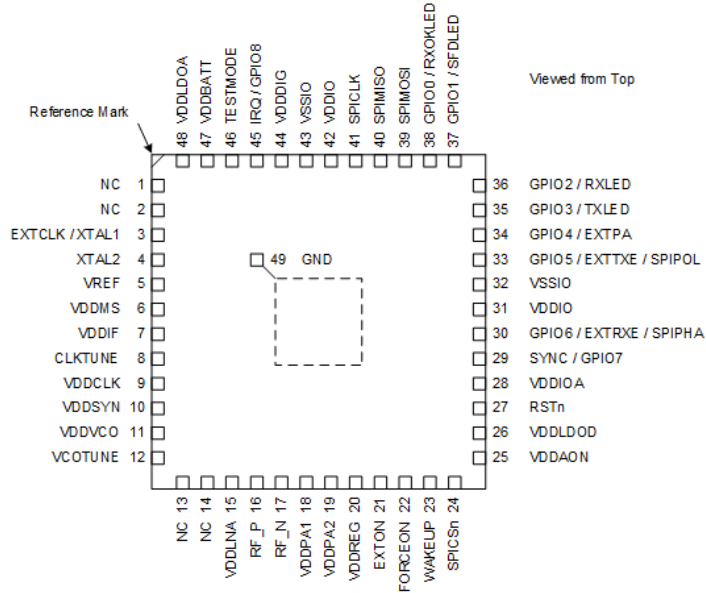

Figure 2: DW1000 Pin Assignments

2.2 Pin Descriptions

Table 1: DW1000 Pin functions

SIGNAL NAME	PIN	I/O (default)	DESCRIPTION
Crystal Interface			
EXTCLK / XTAL1	3	AI	Reference crystal input or external reference overdrive pin.
XTAL2	4	AI	Reference crystal input. Leave floating if external clock is used.
Digital Interface			
SPICK	41	DI	SPI clock
SPIMISO	40	DO (O-L)	SPI data output. Refer to section 5.8.
SPIMOSI	39	DI	SPI data input. Refer to section 5.8.
SPICSn	24	DI	SPI chip select. This is an active low enable input. The high-to-low transition on SPICSn signals the start of a new SPI transaction. SPICSn can also act as a wake-up signal to bring DW1000 out of either SLEEP or DEEPSLEEP states. Refer to section 6.
SYNC / GPIO7	29	DIO (I)	The SYNC input pin is used for external synchronization (see section 5.13). When the SYNC input functionality is not being used this pin may be reconfigured as a general purpose I/O pin, GPIO7.
WAKEUP	23	DI	When asserted into its active high state, the WAKEUP pin brings the DW1000 out of SLEEP or DEEPSLEEP states into operational mode. When this pin is not being used as WAKEUP it should be tied to VSSIO
EXTON	21	DO (O-L)	External device enable. Asserted during wake-up process and held active until device enters sleep mode. Can be used to control external DC-DC converters or other circuits that are not required when the device is in sleep mode so as to minimize power consumption. Refer to sections 5.5.1 & 7. EXTON can be left floating if not used.

SIGNAL NAME	PIN	I/O (default)	DESCRIPTION
FORCEON	22	DI	Not used in normal operation. Must be connected to ground
IRQ / GPIO8	45	DIO (O-L)	Interrupt Request output from the DW1000 to the host processor. By default IRQ is an active-high output but may be configured to be active low if required. For correct operation in SLEEP and DEEPSLEEP modes it should be configured for active high operation. This pin will float in SLEEP and DEEPSLEEP states and may cause spurious interrupts unless pulled low. When the IRQ functionality is not being used the pin may be reconfigured as a general purpose I/O line, GPIO8. This pin has an internal pulldown to VSSIO and can be left unconnected if not being used.
GPIO6 / EXTRXE / SPIPHA	30	DIO (I)	General purpose I/O pin. On power-up it acts as the SPIPHA (SPI phase selection) pin for configuring the SPI operation mode. For details of this please refer to section 5.8. After power-up, the pin will default to a General Purpose I/O pin. It may be configured for use as EXTRXE (External Receiver Enable). This pin goes high when the DW1000 is in receive mode. This pin has an internal pulldown to VSSIO and can be left unconnected if not being used.
GPIO5 / EXTTXE / SPIPOL	33	DIO (I)	General purpose I/O pin. On power-up it acts as the SPIPOL (SPI polarity selection) pin for configuring the SPI mode of operation. Refer to section 5.8 for further information. After power-up, the pin will default to a General Purpose I/O pin. It may be configured for use as EXTTXE (External Transmit Enable). This pin goes high when the DW1000 is in transmit mode. This pin has an internal pulldown to VSSIO and can be left unconnected if not being used.
GPIO4 / EXTPA	34	DIO (I)	General purpose I/O pin. It may be configured for use as EXTPA (External Power Amplifier). This pin can enable an external Power Amplifier. This pin has an internal pulldown to VSSIO and can be left unconnected if not being used.
GPIO3 / TXLED	35	DIO (I)	General purpose I/O pin. It may be configured for use as a TXLED driving pin that can be used to light a LED following a transmission. Refer to the DW1000 User Manual [2] for details of LED use. This pin has an internal pulldown to VSSIO and can be left unconnected if not being used.
GPIO2 / RXLED	36	DIO (I)	General purpose I/O pin. It may be configured for use as a RXLED driving pin that can be used to light a LED during receive mode. Refer to the DW1000 User Manual [2] for details of LED use. This pin has an internal pulldown to VSSIO and can be left unconnected if not being used.
GPIO1 / SFDLED	37	DIO (I)	General purpose I/O pin. It may be configured for use as a SFDLED driving pin that can be used to light a LED when SFD (Start Frame Delimiter) is found by the receiver. Refer to the DW1000 User Manual [2] for details of LED use. This pin has an internal pulldown to VSSIO and can be left unconnected if not being used.
GPIO0 / RXOKLED	38	DIO (I)	General purpose I/O pin. It may be configured for use as a RXOKLED driving pin that can be used to light a LED on reception of a good frame. Refer to the DW1000 User Manual [2] for details of LED use. This pin has an internal pulldown to VSSIO and can be left unconnected if not being used.

SIGNAL NAME	PIN	I/O (default)	DESCRIPTION
RSTn	27	DIO (O-H)	Reset pin. Active Low Output. May be pulled low by external open drain driver to reset the DW1000. Must not be pulled high by external source. Refer to section 5.6.
TESTMODE	46	DI	Not used in normal operation. Must be connected to ground.
Reference voltages			
VREF	5	AIO	Used for on-chip reference current generation. Must be connected to an 11 k Ω (1% tolerance) resistor to ground.
Digital Power Supplies			
VDDLDDOD	26	P	External supply for digital circuits.
VDDIOA	28	P	External supply for digital IO ring.
VSSIO	32 43	G	Negative I/O ring supply. Must be connected to ground.
Digital Decoupling			
VDDREG	20	PD	Output of on-chip regulator. Connect to VDDDIG on PCB. Requires a local 100 nF capacitor to VSSIO.
VDDDIG	44	PD	Output of on-chip regulator. Connect to VDDREG on PCB. Requires a local 100 nF capacitor to VSSIO.
VDDIO	31 42	PD	Digital IO Ring Decoupling.
RF Interface			
RF_P	16	AIO	Positive pin of the 100 Ω differential RF pair. Should be AC coupled.
RF_N	17	AIO	Negative pin of the 100 Ω differential RF pair. Should be AC coupled.
PLL Interface			
CLKTUNE	8	AIO	Clock PLL loop filter connection to off-chip filter components. Referenced to VDDCLK.
VCOTUNE	12	AIO	RF PLL loop filter connection to off-chip filter components. Referenced to VDDVCO.
Analog Power Supplies			
VDDAON	25	P	External supply for the Always-On (AON) portion of the chip. See 7.3
VDDPA1	18	P	External supply to the transmitter power amplifier.
VDDPA2	19	P	External supply to the transmitter power amplifier.
VDDLNA	15	P	External supply to the receiver LNA.
VDDLDOA	48	P	External supply to analog circuits.
VddbATT	47	P	External supply to all other on-chip circuits. If a TCXO is being used with the DW1000 this pin should be supplied by the regulated supply used to power the TCXO. See Figure 37.
Analog Supply Decoupling			
VDDCLK	9	PD	Output of on-chip regulator to off-chip decoupling capacitor.
VDDIF	7	PD	Output of on-chip regulator to off-chip decoupling capacitor.
VDDMS	6	PD	Output of on-chip regulator to off-chip decoupling capacitor.
VDDSYN	10	PD	Output of on-chip regulator to off-chip decoupling capacitor.
VDDVCO	11	PD	Output of on-chip regulator to off-chip decoupling capacitor.
Ground Paddle			
GND	49	G	Ground Paddle on underside of package. Must be soldered to the PCB ground plane for thermal and RF performance.
Others			

SIGNAL NAME	PIN	I/O (default)	DESCRIPTION
NC	1 2 13 14	NC	Not used in normal operation. Do not connect.

Table 2: Explanation of Abbreviations

ABBREVIATION	EXPLANATION
AI	Analog Input
AIO	Analog Input / Output
AO	Analog Output
DI	Digital Input
DIO	Digital Input / Output
DO	Digital Output
G	Ground
P	Power Supply
PD	Power Decoupling
NC	No Connect
O-L	Defaults to output, low level after reset
O-H	Defaults to output, high level after reset
I	Defaults to input.
<i>Note: Any signal with the suffix 'n' indicates an active low signal.</i>	

3 ELECTRICAL SPECIFICATIONS

3.1 Nominal Operating Conditions

Table 3: DW1000 Operating Conditions

Parameter	Min.	Typ.	Max.	Units	Condition/Note
Operating temperature	-40		+85	°C	
Supply voltage VDDIOA	2.8	3.3	3.6	V	
Supply voltage VDDBAT, VDDAON, VDDLNA, VDDPA	2.8	3.3	3.6	V	
Supply voltage VDDLDOA, VDDLDOA	1.6	1.8	3.6	V	See section 7.2
Optional: Supply voltage VDDIO	3.7	3.8	3.9	V	Only to be used if programming the OTP memory. See the DW1000 User Manual [2] for details.
Voltage on GPIO0..8, WAKEUP, RSTn, SPICSn, SPIMOSI, SPICLK, TESTMODE, FORCEON			3.6	V	Note that 3.6 V is the max voltage that should be applied to these pins

Note: Unit operation is guaranteed by design when operating within these ranges

3.2 DC Characteristics

$T_{amb} = 25\text{ }^{\circ}\text{C}$, all supplies centered on typical values

Table 4: DW1000 DC Characteristics

Parameter	Min.	Typ.	Max.	Units	Condition/Note
Supply current DEEPSLEEP mode		50		nA	Total current drawn from all 3.3 V and 1.8 V supplies.
Supply current SLEEP mode		1		μA	
Supply current IDLE mode		19		mA	
Supply current INIT mode		5		mA	
TX : 3.3 V supplies (VDDBAT, VDDPA1, VDDPA2, VDDLNA, VDDAON, VDDIOA)			70	mA	Channel 5 TX Power = MAX mean (-9.3 dBm/500 MHz)
TX : 1.8 V supplies (VDDLDOA, VDDLDOA)			90*	mA	
RX : 3.3 V supplies (VDDBAT, VDDPA1, VDDPA2, VDDLNA, VDDAON, VDDIOA)			30	mA	Channel 5
RX : 1.8 V supplies (VDDLDOA, VDDLDOA)			210*	mA	
Digital input voltage high	0.7*VDDIO			V	
Digital input voltage low			0.3*VDDIO	V	
Digital output voltage high	0.7*VDDIO			V	Assumes 500 Ω load.
Digital output voltage low			0.3*VDDIO	V	Assumes 500 Ω load.
Digital Output Drive Current GPIOx, IRQ SPIMISO EXTON	4 8 3	6 10 4		mA	

* These currents are on the 1.8 V supplies, not referenced back to the 3.3 V supply

3.3 Receiver AC Characteristics

$T_{amb} = 25\text{ }^{\circ}\text{C}$, all supplies centered on nominal values

Table 5: DW1000 Receiver AC Characteristics

Parameter	Min.	Typ.	Max.	Units	Condition/Note
Frequency range	3244		6999	MHz	
Channel bandwidths		500 900		MHz	Channel 1,2,3 and 5 Channel 4 and 7
Input P1Db compression point			-39	dBm	Measured at balun input
In-band blocking level*		30		dBc	Continuous wave interferer
Out-of-band blocking level*		55		dBc	Continuous wave interferer
Relative velocity between Receiver & Transmitter	0		5	m/s	4096 preamble 110kbps, 128 bytes
	0		500	m/s	64 preamble 6.8 Mbps, 12 bytes

*Blocking level is power relative to reference sensitivity level plus 3 dB to cause 1% packet error rate, e.g. -60 dBm in-band blocking for -93 dBm receiver sensitivity.

A continuous wave interferer is one which has no modulation applied - just a sinusoidal signal. In-band blocking is where the interferer is within the UWB channel bandwidth being used and out-of-band is where the interferer is outside the channel bandwidth.

3.4 Receiver Sensitivity Characteristics

$T_{amb} = 25\text{ }^{\circ}\text{C}$, all supplies centered on typical values. 20 byte payload

Table 6: Typical Receiver Sensitivity Characteristics

Packet Error Rate	Data Rate	Typical Receiver Sensitivity	Units	Condition/Note		
1%	110 kbps	-106	dBm/500 MHz	Preamble 2048	Carrier frequency offset ± 1 ppm. Requires use of the "tight" Rx operating parameter set – see [2]	All measurements performed on Channel 5, PRF 16 MHz. Channel 2 is approximately 1 dB less sensitive
10%	110 kbps	-107	dBm/500 MHz	Preamble 2048		
1%	110 kbps	-102	dBm/500 MHz	Preamble 2048	Carrier frequency offset ± 10 ppm	
	850 kbps	-101	dBm/500 MHz	Preamble 1024		
10%	6.8 Mbps	-93 (*-97)	dBm/500 MHz	Preamble 256		
	110 kbps	-106	dBm/500 MHz	Preamble 2048		
	850 kbps	-102	dBm/500 MHz	Preamble 1024		
	6.8 Mbps	-94 (*-98)	dBm/500 MHz	Preamble 256		

*equivalent sensitivity with Smart TX Power enabled

3.5 Reference Clock AC Characteristics

$T_{amb} = 25\text{ }^{\circ}\text{C}$, all supplies centered on typical values

3.5.1 Reference Frequency

Table 7: DW1000 Reference Clock AC Characteristics

Parameter	Min.	Typ.	Max.	Units	Condition/Note
Crystal oscillator reference frequency		38.4		MHz	A 38.4 MHz signal can be provided from an external reference in place of a crystal if desired. See Figure 37
Crystal specifications					
Load capacitance	0		35	pF	Depends on crystal used and PCB parasitics
Shunt capacitance	0		4	pF	
Drive level			200	μW	Depends on crystal & load capacitance used
Equivalent Series Resistance (ESR)			60	Ω	
Frequency tolerance			± 20	ppm	DW1000 includes circuitry to trim the crystal oscillator to reduce the initial frequency offset.
Crystal trimming range		± 25		ppm	Trimming range provided by on-chip circuitry. Depends on the crystal used and PCB design.
External Reference					
Amplitude	0.8			V_{pp}	Must be AC coupled. A coupling capacitor value of 2200 pF is recommended
SSB phase noise power density			-132	dBc/Hz	@1 kHz offset.
SSB phase noise power density			-145	dBc/Hz	@10 kHz offset.
Duty Cycle	40		60	%	
Low Power RC Oscillator	5	12	15	kHz	

3.6 Transmitter AC Characteristics

$T_{amb} = 25\text{ }^{\circ}\text{C}$, all supplies centered on typical values

Table 8: DW1000 Transmitter AC Characteristics

Parameter	Min.	Typ.	Max.	Units	Condition/Note
Frequency range	3244		6999	MHz	
Channel Bandwidths		500 900		MHz	Channel 1, 2, 3 and 5 Channel 4 and 7
Output power spectral density (programmable)		-39	-35	dBm/MHz	See Section 5.5
Load impedance		100		Ω	Differential
Power level range		37		dB	
Coarse Power level step		3		dB	
Fine Power level step		0.5		dB	
Output power variation with temperature		0.05		dB/ $^{\circ}\text{C}$	
Output power variation with voltage		2.73 3.34		dB/V	Channel 2 Channel 5

3.7 Temperature and Voltage Monitor Characteristics

Table 9: DW1000 Temperature and Voltage Monitor Characteristics

Parameter	Min.	Typ.	Max.	Units	Condition/Note
Voltage Monitor Range	2.4		3.75	V	
Voltage Monitor Precision		20		mV	
Voltage Monitor Accuracy		140		mV	
Temperature Monitor Range	-40		+100	°C	
Temperature Monitor Precision		0.9		°C	
Temperature Monitor Accuracy		+/-5%		°C	

3.8 Absolute Maximum Ratings

Table 10: DW1000 Absolute Maximum Ratings

Parameter	Min.	Max.	Units
Voltage VDDPA / VDDLNA / VDDLDOA / VDDDBATT / VDDIOA / VDDAON / VDDIO	-0.3	4.0	V
Receiver Power		0	dBm
Temperature - Storage temperature	-65	+150	°C
Temperature - Operating temperature	-40	+85	°C
ESD (Human Body Model)		2000	V

Stresses beyond those listed in this table may cause permanent damage to the device. This is a stress rating only; functional operation of the device at these or any other conditions beyond those indicated in the operating conditions of the specification is not implied. Exposure to the absolute maximum rating conditions for extended periods may affect device reliability.

4 TYPICAL PERFORMANCE

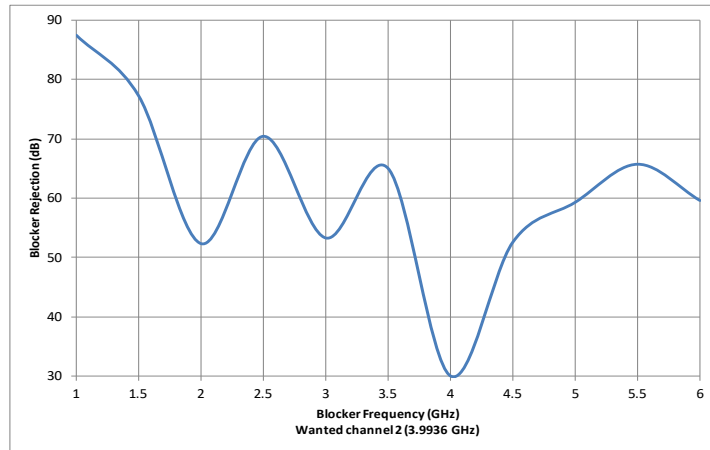

Figure 3 : RX Interferer Immunity on Channel 2

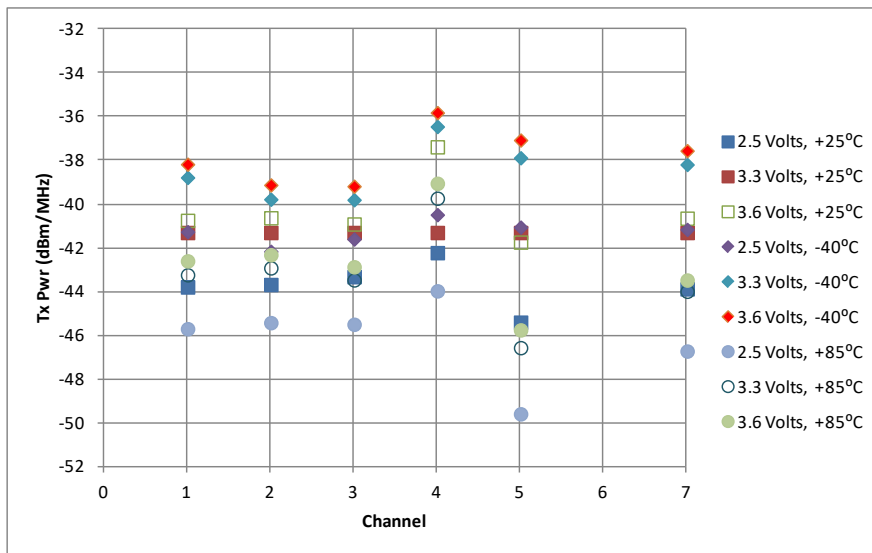

Figure 4: TX output Power over Temp & Voltage

(note that 2.5 volt data points are shown for information only)

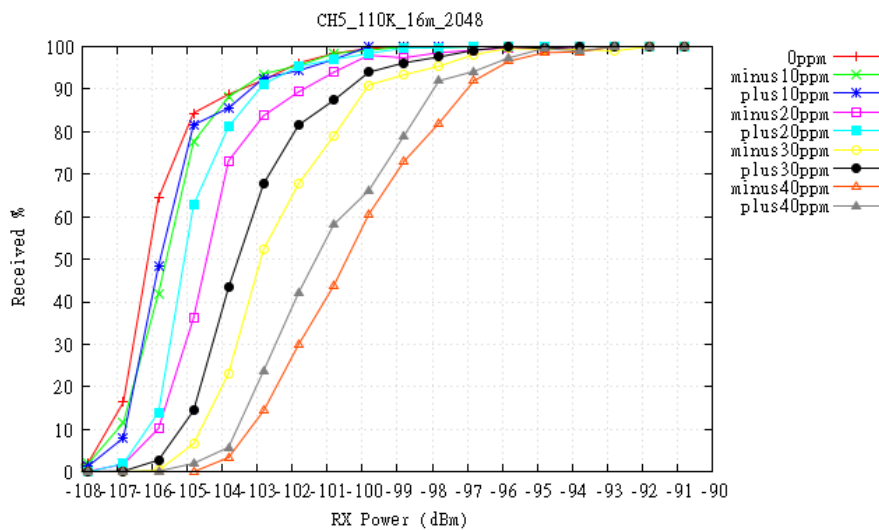

Figure 5: Receiver Sensitivity Channel 5 110kbps Data Rate 16 MHz PRF 2048 Preamble Symbols

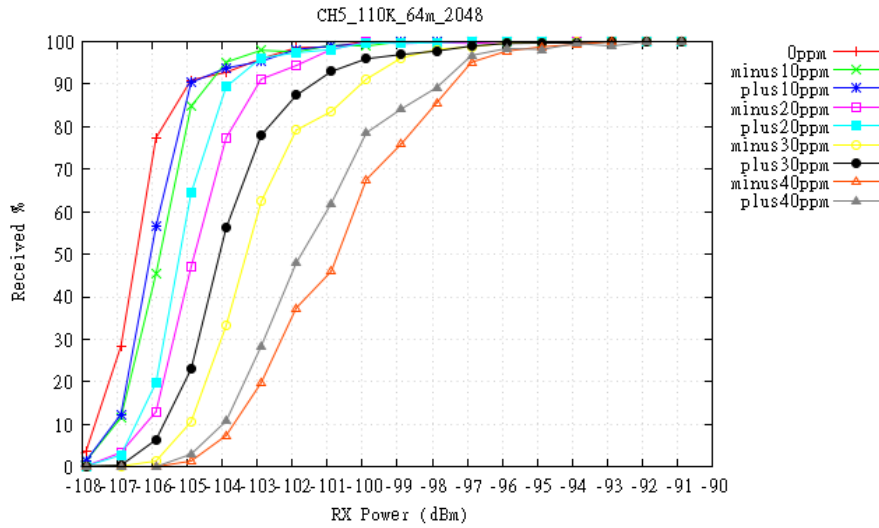

Figure 6: Receiver Sensitivity Channel 5 110kbps Data Rate 64 MHz PRF 2048 Preamble Symbols

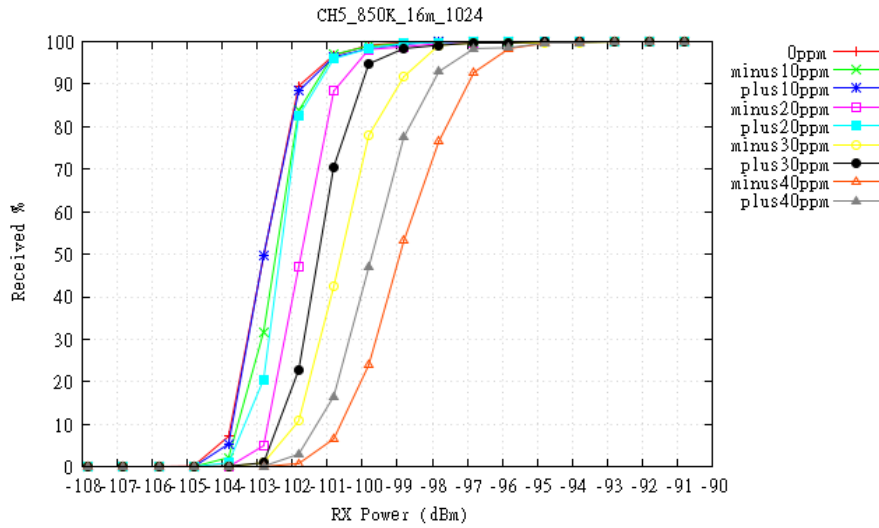

Figure 7: Receiver Sensitivity Channel 5 850kbps Data Rate 16 MHz PRF 1024 Preamble Symbols

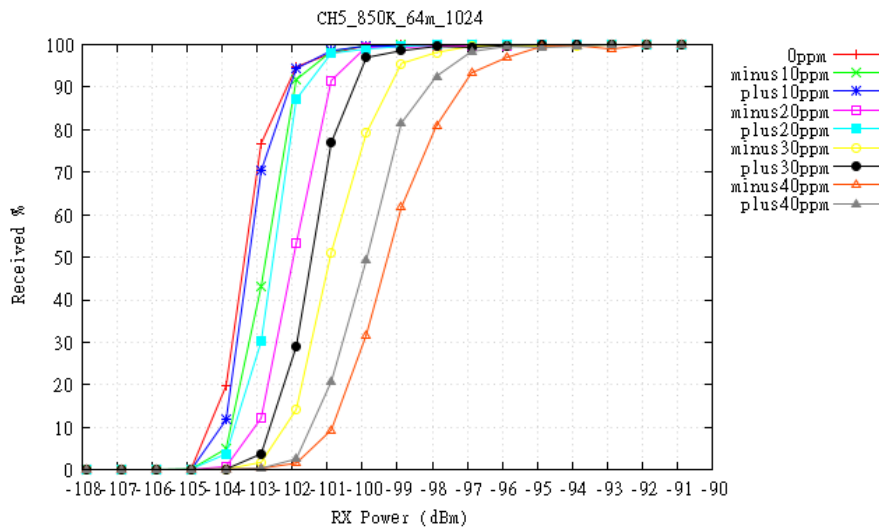

Figure 8: Receiver Sensitivity Channel 5 850kbps Data Rate 64 MHz PRF 1024 Preamble Symbols

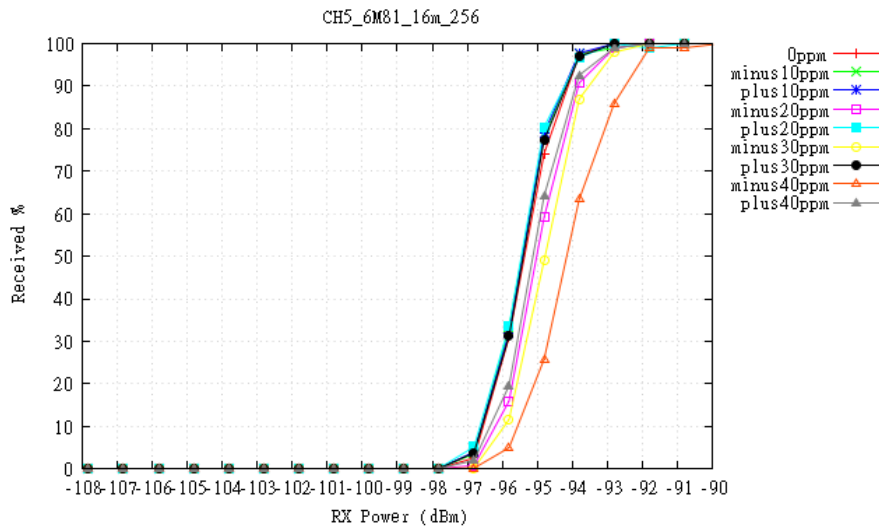

Figure 9: Receiver Sensitivity Channel 5 6.81Mbps Data Rate 16 MHz PRF 256 Preamble Symbols

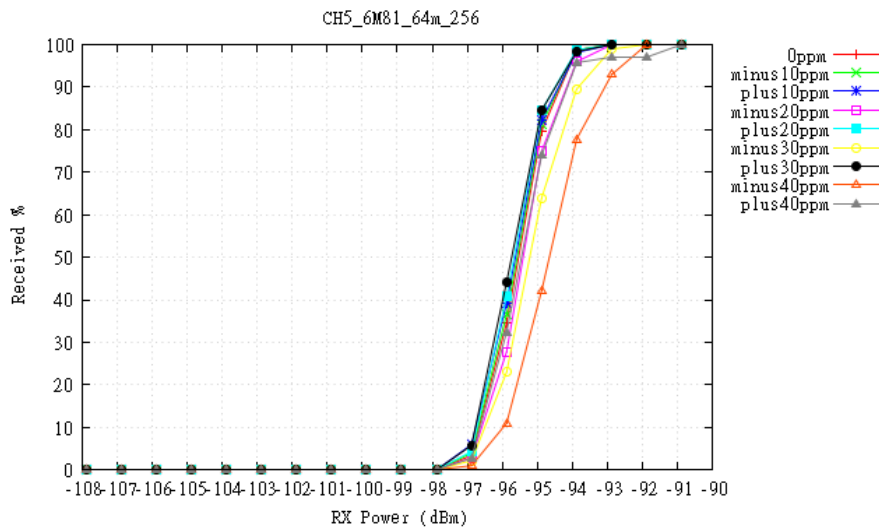

Figure 10: Receiver Sensitivity Channel 5 6.81Mbps Data Rate 64 MHz PRF 1256 Preamble Symbols

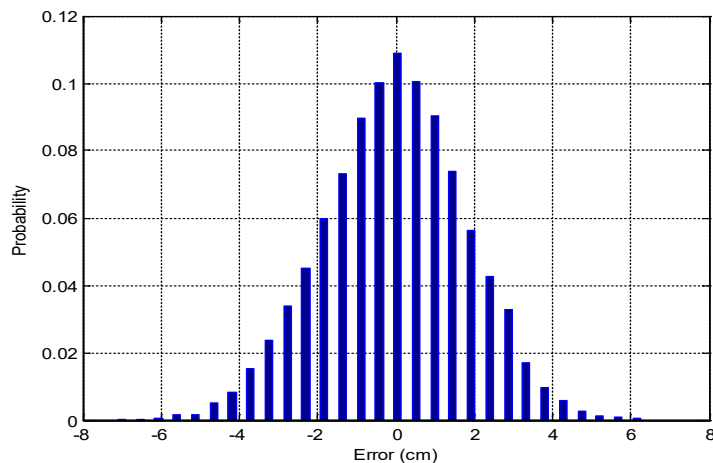
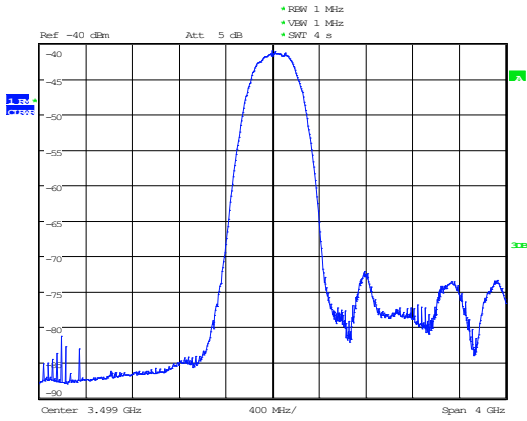
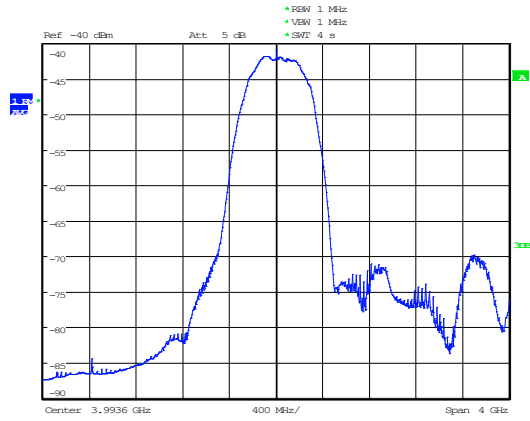

Figure 11: Typical probability distribution of Line of Sight 2-way ranging performance



Date: 25.SEP.2013 16:07:44

Figure 12: TX Spectrum Channel 1



Date: 25.SEP.2013 15:47:44

Figure 13: TX Spectrum Channel 2

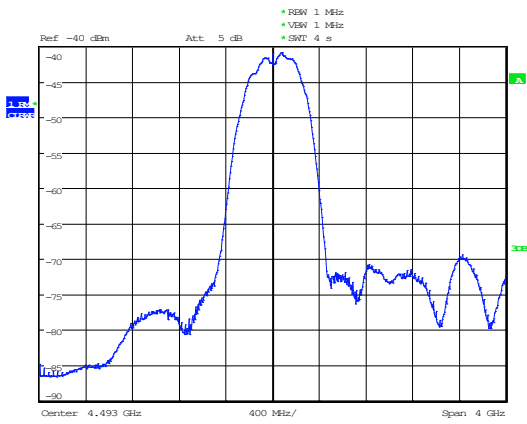

Date: 25.SEP.2013 16:09:23

Figure 14: TX Spectrum Channel 3

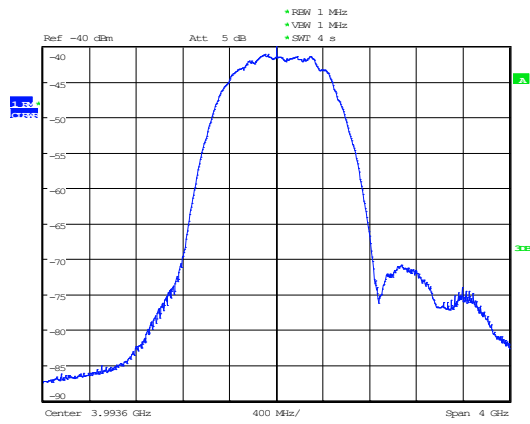

Date: 25.SEP.2013 15:49:33

Figure 15: TX Spectrum Channel 4

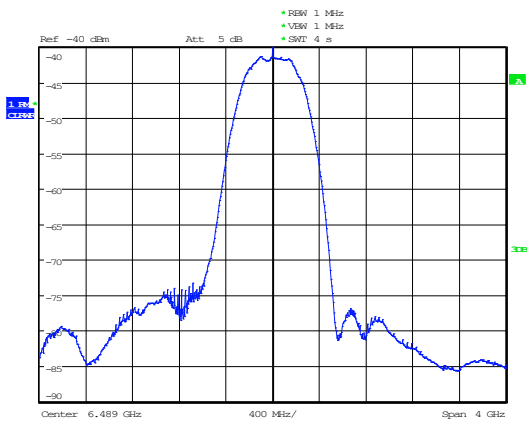

Date: 25.SEP.2013 16:10:30

Figure 16: TX Spectrum Channel 5

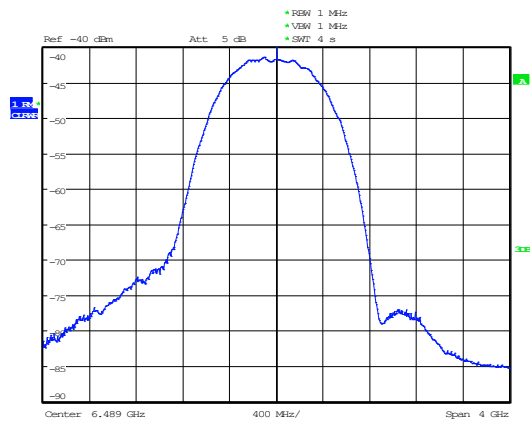

Date: 25.SEP.2013 16:20:23

Figure 17: TX Spectrum Channel 7

5 FUNCTIONAL DESCRIPTION

5.1 Physical Layer Modes

Please refer to IEEE802.15.4-2011 [1] for the PHY specification.

5.1.1 Supported Channels and Bandwidths

The DW1000 supports the following six IEEE802.15.4-2011 [1] UWB channels: -

Table 11: Channels supported by the DW1000

UWB Channel Number	Centre Frequency (MHz)	Band (MHz)	Bandwidth (MHz)
1	3494.4	3244.8 – 3744	499.2
2	3993.6	3774 – 4243.2	499.2
3	4492.8	4243.2 – 4742.4	499.2
4	3993.6	3328 – 4659.2	1331.2*
5	6489.6	6240 – 6739.2	499.2
7	6489.6	5980.3 – 6998.9	1081.6*

*DW1000 maximum receiver bandwidth is approximately 900 MHz

5.1.2 Supported Bit Rates and Pulse Repetition Frequencies (PRF)

The DW1000 supports standard bit rates of 110 kbps, 850 kbps and 6.81 Mbps and nominal PRF values of 16 and 64 MHz.

Table 12: UWB bit rates and PRF modes supported by the DW1000

PRF* (MHz)	Data Rate (Mbps)
16	0.11
16	0.85
16	6.81
64	0.11
64	0.85
64	6.81

*Actual PRF mean values are slightly higher for SYNC as opposed to the other portions of a frame. Mean PRF values are 16.1/15.6 MHz and 62.89/62.4 MHz, nominally referred to as 16 and 64MHz in this document. Refer to [1] for full details of peak and mean PRFs.

Generally speaking, lower data rates give increased receiver sensitivity, increased link margin and longer range but due to longer frame lengths for a given number of data bytes they result in increased air occupancy per frame and a reduction in the number of individual transmissions that can take place per unit time.

16 MHz PRF gives a marginal reduction in transmitter power consumption over 64 MHz PRF.

When using 16 MHz and 64 MHz PRF on the same physical while using different preamble codes some interference may result because while the preamble codes have a low cross-correlation they are not orthogonal. See APH010 [6] for further details on channel interference.

5.1.3 Frame Format

UWB frames are structured as shown in Figure 18. Detailed descriptions of the frame format are given in the UWB standard [1]. The frame consists of a synchronisation header (SHR) which includes the preamble symbols and start frame delimiter (SFD), followed by the PHY header (PHR) and data. The data frame is usually specified in number of bytes and the frame format will include 48 Reed-Solomon parity bits following each block of 330 data bits (or less).

The maximum standard frame length is 127 bytes, including the 2-byte FCS.

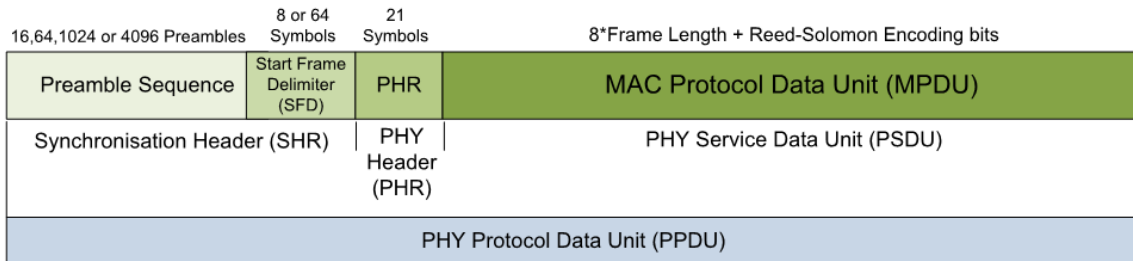

Figure 18: IEEE802.15.4-2011 PPDU Structure

5.1.4 Symbol Timings

Timing durations in UWB standard are expressed in an integer number of symbols. This convention is adopted in DW1000 documentation. Symbol times vary depending on the data rate and PRF configuration of the device and the part of the frame. See Table 13: DW1000 Symbol Durations, for all symbol timings supported by DW1000.

Table 13: DW1000 Symbol Durations

PRF (MHz)	Data Rate (Mbps)	SHR (ns)	PHR (ns)	Data (ns)
16	0.11	993.59	8205.13	8205.13
16	0.85	993.59	1025.64	1025.64
16	6.81	993.59	1025.64	128.21
64	0.11	1017.63	8205.13	8205.13
64	0.85	1017.63	1025.64	1025.64
64	6.81	1017.63	1025.64	128.21

5.1.5 Proprietary Long Frames

The DW1000 offers a proprietary long frame mode where frames of up to 1023 bytes may be transferred. This requires a non-standard PHR encoding and so cannot be used in a standard system. Refer to the DW1000 User Manual for full details [2].

5.1.6 Turnaround Times

Turn-around times given in the table below are as defined in [1].

Table 14: Turn-around Times

Parameter	Min.	Typ.	Max.	Units	Condition/Note
Turn-around time RX to TX*		10		µs	Achievable turnaround time depends on device configuration and frame parameters and on external host controller.
Turn-around time TX to RX*		6		µs	

5.1.7 Frame Filter

A standard frame filtering format is defined in IEEE802.15.4-2011 [1]. An overview of the MAC frame format is given in Figure 19. Note that the Auxiliary Security Header is not processed in DW1000 hardware.

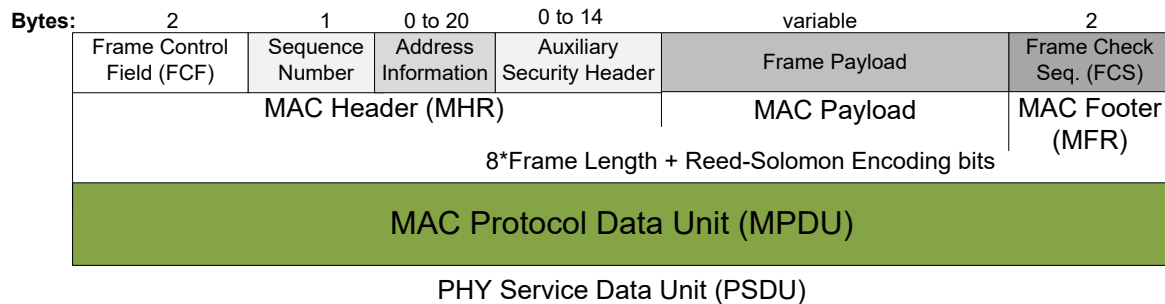

Figure 19: IEEE802.15.4-2011 MAC Frame Format

Frame filtering allows the receiver to automatically discard frames that do not match a defined set of criteria. The DW1000 has a number of separately configurable frame filtering criteria to allow selection of the frame types to accept or discard. See IEEE802.15.4-2011 standard [1] for filtering field definition and acceptance rules.

5.1.8 Frame Check Sequence (FCS)

The FCS is also known as the MAC Footer (MFR). It is a 2-byte CRC appended to frames. See standard for information on FCS generation.

5.2 Reference Crystal Oscillator

The on-chip crystal oscillator generates the reference frequency for the integrated frequency synthesizers RFPLL and CLKPLL. The oscillator operates at a frequency of 38.4 MHz.

DW1000 provides the facility to trim out initial frequency error in the 38.4 MHz reference crystal, see section 5.14. The trimming range depends on the crystal chosen and the loading capacitors used. Typically a trimming range of ± 25 ppm is possible. Loading capacitors should be chosen such that minimum frequency error (from the channel center frequency) is achieved when the trim value is approximately mid-range.

In applications that require tighter frequency tolerance (maximum range) an external oscillator such as a TCXO can be used to drive the XTAL1 pin directly.

5.3 Synthesizer

DW1000 contains 2 frequency synthesizers, RFPLL which is used as a local oscillator (LO) for the TX and RX and CLKPLL which is used as a system clock. Both of these synthesizers are fully integrated apart from external passive 2nd order loop filters. The component values for these loop filters do not change regardless of the RF channel used. The register programming values for these synthesizers is contained in the user manual [2]

5.4 Receiver

5.4.1 Bandwidth setting

The receiver can be configured to operate in one of two bandwidth modes; 500 MHz or 900 MHz. The selection of a particular bandwidth mode is made by register settings and is described in the DW1000 User Manual [2].

5.4.2 Automatic Gain Control (AGC)

Automatic Gain Control is provided to ensure optimum receiver performance by adjusting receiver gain for changing signal and environmental conditions. The DW1000 monitors the received signal level and makes appropriate automatic adjustments to ensure optimum receiver performance is maintained.

5.5 Transmitter

5.5.1 Transmit Output Power

DW1000 transmit power is fully adjustable as is the transmit spectrum width ensuring that applicable regulatory standards such as FCC [4] and ETSI [3] can be met. For maximum range the transmit power should be set such that the EIRP at the antenna is as close as possible to the maximum allowed, -41.3 dBm/MHz in most regions. See section 5.14.3 for more details.

5.5.2 Transmit Bandwidth Setting

The transmitter can be configured to operate over a wide range of bandwidths. The selection of a particular bandwidth mode is made by register settings and is described in the DW1000 User Manual [2]

Transmit spectral shape can also be adjusted to compensate for PCB and external components in order to give an optimal transmit spectral mask.

5.6 Power-up sequence

5.6.1 Typical power-up sequence

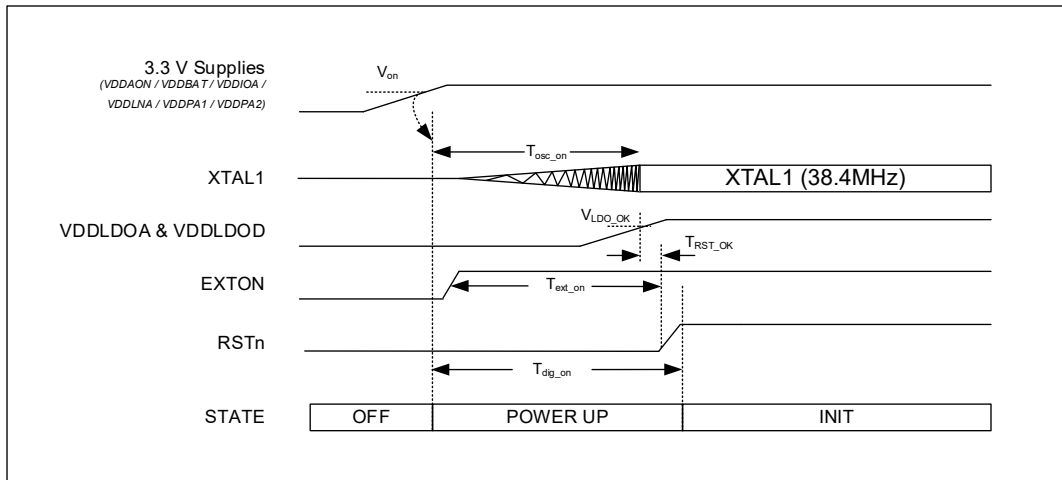

Figure 20: DW1000 Power-up Sequence

When power is applied to the DW1000, RSTn is driven low by the DW1000 internal circuitry as part of its power up sequence. See Figure 20 above. RSTn remains low until the XTAL oscillator has powered up and its output is suitable for use by the rest of the device. Once that time is reached the DW1000 de-asserts RSTn.

Table 15: DW1000 Power-up Timings

Parameter	Description	Min Value	Nominal Value	Units
V _{ON}	Voltage threshold to enable overall IC power up.		2.0	V
T _{OSC_ON}	Time taken for oscillator to start up and stabilise.	1.0	1.5	ms
T _{EXT_ON}	EXTON goes high this long before RSTn is released.	1.5	2	ms
T _{DIG_ON}	RSTn held low by internal reset circuit / driven low by external reset circuit.	1.5	2	ms
V _{LDO_OK}	Voltage threshold on the VDDLDOA supply at which the digital core powers up.	1.6		V
T _{RST_OK}	Time for which RSTn must continue to remain low once VDDLDOA exceeds V _{LDO_OK} min. If T _{RST_OK} min cannot be met due to the timing of the VDDLDOA supply ramp then RSTn should be manually driven low for at least T _{RST_OK} min time to ensure correct reset operation	10	50	ns

5.6.2 Variation in the power-up sequence

It is possible, that in some circuit arrangements, the start-up sequence may need to be altered. This can happen if, for example, the VDDLDOA supply is controlled via an external controller or if a slow ramp regulator is used to provide the VDDLDOA supply. In these situations the RSTn pin would have to be controlled by the external circuitry to ensure the digital circuits receive proper reset on power up.

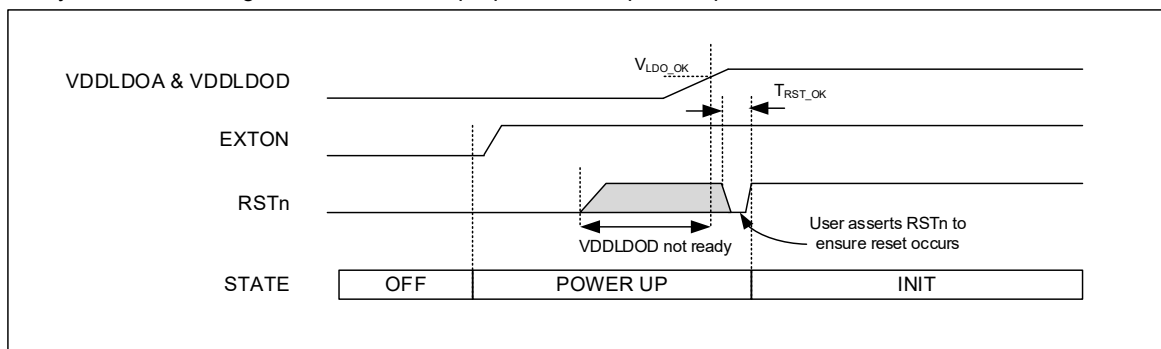

Figure 21: Power up example where VDDLDOA cannot be guaranteed to be ready in time for the RSTn going high

Figure 21 shows a situation where the VDDL DOD supply is not high until after the first RSTn low to high transition (start of shaded area of RSTn). In this case the external circuitry must pull RSTn down again after the VDDL DOD supply has exceeded V_{LDO_OK} . This will ensure the digital circuits receive proper reset on power up. The RSTn pin should be either held low during power up until T_{RST_OK} is met or driven low for a minimum of T_{RST_OK} .

5.6.3 External control of RSTn / use of RSTn by external circuitry

5.6.3.1 External control of RSTn

An external circuit can reset the DW1000 by asserting RSTn for a minimum of T_{RST_OK} . RSTn is an asynchronous input. DW1000 initialization will proceed when the RSTn pin is released to high impedance.

An external source should open-drain the RSTn pin once the DW1000 has been reset. If RSTn is controlled by a GPIO of an external micro-controller care should be taken to ensure that the GPIO is configured as high-impedance as soon as it is released from the LOW state.

When in DEEPSLEEP mode, the DW1000 drives RSTn to ground. This can result in current flowing if RSTn is driven high externally and will result in incorrect wake-up operation.

RSTn should never be driven high by an external source.

5.6.3.2 Use of RSTn by external circuitry

Table 16: External use of RSTn

Use of RSTn	Description
As output to control external circuitry	RSTn may be used as an output to reset external circuitry as part of an orderly bring up of a system as power is applied.
As interrupt input to external host	RSTn may be used as an interrupt input to the external host to indicate that the DW1000 has entered the INIT state. When RSTn is used in this way care should be taken to ensure that the interrupt pin of the external host does not pull-up the RSTn signal which should be left open-drain. Refer to Table 1 and Figure 37.

5.7 Voltage/Temperature Monitors

The on-chip voltage and temperature monitors allow the host to read the voltage on the VDDAON pin and the internal die temperature information from the DW1000. See Table 9 for characteristics.

5.8 Host Controller Interface

The DW1000 host communications interface is a slave-only SPI. Both clock polarities (SPIPOL=0/1) and phases (SPIPHA=0/1) are supported. The data transfer protocol supports single and multiple byte read/writes accesses. All bytes are transferred MSB first and LSB last. A transfer is initiated by asserting SPICSn low and terminated when SPICSn is deasserted high.

The DW1000 transfer protocols for each SPIPOL and SPIPHA setting are given in Figure 22 and Figure 23.

Note: Figure 22 and Figure 23 detail the SPI protocol as defined for SPICLK polarities and phases. The sampling and launch edges used by the SPI bus master are shown. DW1000 is a SPI slave device and will comply with the protocol by ensuring that the SPIMISO data is valid on the required SPICLK edge with setup and hold times as given by Table 18.

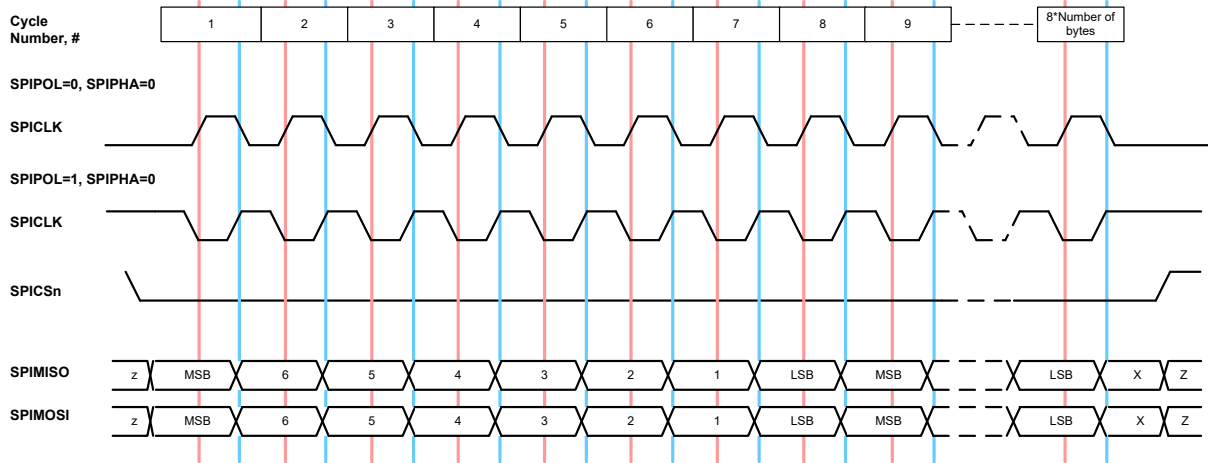

Figure 22: DW1000 SPIPHA=0 Transfer Protocol

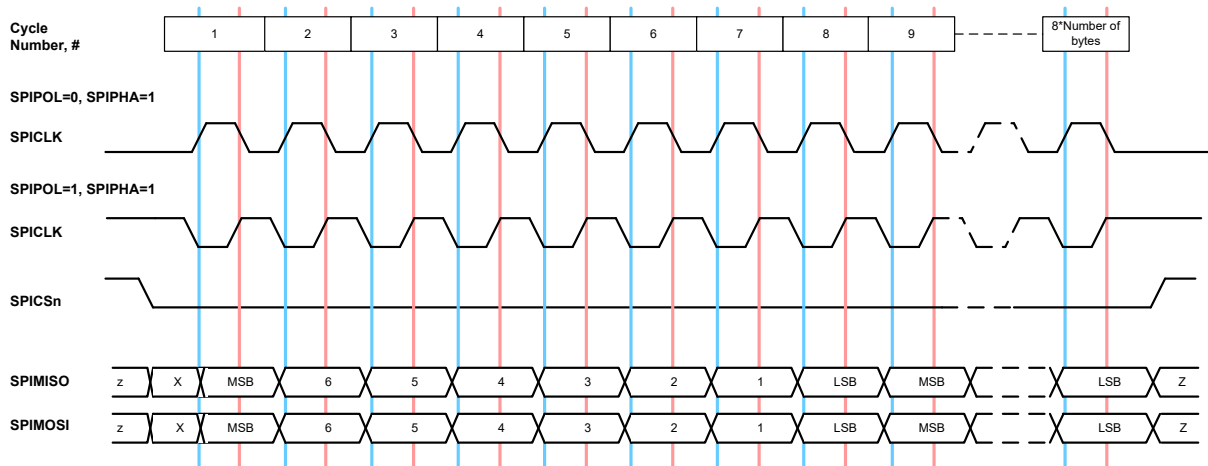

Figure 23: DW1000 SPIPHA=1 Transfer Protocol

The MSB of the first byte is the read/write indicator, a low bit indicates a read access and a high bit indicates a write access. The second bit, bit 6 of the first byte, indicates whether a sub address byte will be included in the SPI access, a high bit indicates a further address byte to follow the initial byte and a low bit indicating that the bytes to follow the first byte are data. The 6 LSBs of the first byte contain an access address.

The second byte of a transfer command, if included, gives the sub address being accessed. If the MSB of this optional second byte is high, it indicates a second sub address byte to follow in the third transfer byte. The 7 LSBs of this second byte give the 7 LSBs of the sub address.

The third byte of a transfer command, if included give the 8 MSBs of the sub address.

The number of data bytes to follow the 1-3 command bytes is not limited by the DW1000 transfer protocol.

Figure 24: SPI Byte Formatting

Byte	Bit 7	Bit 6	Bit 5	Bit 4	Bit 3	Bit 2	Bit 1	Bit 0
Command	Read/Write 0 – Read 1 – Write	Sub address 0 – no sub address 1 – sub address present	6-bit access address					
Sub Address 0 (Optional)	Extended sub address 0 – 1 byte sub address 1 – 2 byte sub address	7-bits of sub address. These will be the LSBs if more bits are to follow.						
Sub Address 1 (Optional)	8 bits of sub address. These will form the MSBs, bits [14:7] of the 15-bit sub address.							
Data	8-bit read/write bytes (variable number).							

The SPIMISO line may be connected to multiple slave SPI devices each of which is required to go open-drain when their respective SPICSn lines are de-asserted.

The DW1000 has internal pull up and pull down circuits to ensure safe operation in the event of the host interface signals being disconnected. These are for internal use only, and should not be used to pull an external signal high or low.

Internal pull-down resistance values are in the range 34 kΩ – 90 kΩ, internal pull-up resistance values are in the range 40 kΩ - 90 kΩ.

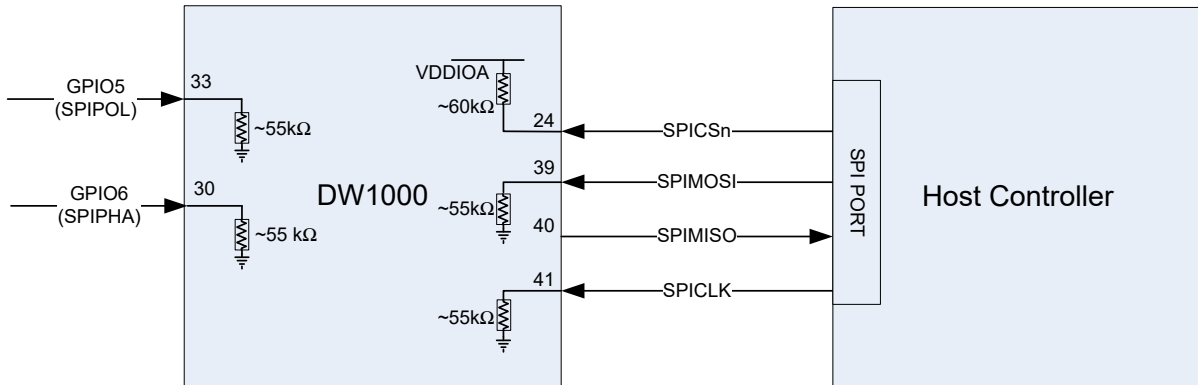

Figure 25: SPI Connections

More details of the protocol used for data transfer, the description of the accessible registers and the description of the bit functions of those registers are published in the DW1000 User Manual [2].

5.8.1 Configuring the SPI Mode

The SPI interface supports a number of different clock polarity and clock / data phase modes of operation. These modes are selected using GPIO5 & 6 as follows: -

Table 17: DW1000 SPI Mode Configuration

GPIO 5 (SPIPOL)	GPIO 6 (SIPPHA)	SPI Mode	Description (from the master / host point of view)
0	0	0	Data is sampled on the rising (first) edge of the clock and launched on the falling (second) edge.
0	1	1	Data is sampled on the falling (second) edge of the clock and launched on the rising (first) edge.
1	0	2	Data is sampled on the falling (first) edge of the clock and launched on the rising (second) edge.
1	1	3	Data is sampled on the rising (second) edge of the clock and launched on the falling (first) edge.

Note: The 0 on the GPIO pins can either be open circuit or a pull down to ground. The 1 on the GPIO pins is a pull up to VDDIO.

GPIO 5 / 6 are sampled / latched on the rising edge of the RSTn pin to determine the SPI mode. They are internally pulled low to configure a default SPI mode 0 without the use of external components. If a mode other 0 is required then they should be pulled up using an external resistor of value no greater than 10 kΩ to the VDDIO output supply.

If GPIO5 / 6 are also being used to control an external transmit / receive switch then external pull-up resistors of no less than 1 kΩ should be used so that the DW1000 can correctly drive these outputs in normal operation after the reset sequence / SPI configuration operation is complete.

The recommended range of resistance values to pull-up GPIO 5 / 6 is in the range of 1-10 kΩ. If it is required to pull-down GPIO 5 / 6, such as in the case where the signal is also pulled high at the input to an external IC, the resistor value chosen needs to take account of the DW1000 internal pull-down resistor values as well as those of any connected external pull-up resistors.

It is possible to set the SPI mode using the DW1000's one-time programmable configuration block to avoid the need for external components and to leave the GPIO free for use. This is a one-time activity and cannot be reversed so care must be taken to ensure that the desired SPI mode is set. Please refer to the DW1000 User Manual [2] for details of OTP use and configuration.

The operating mode of the SPI is determined when the DW1000's digital control function is initialised as a result of a device reset or is woken up from a SLEEP or DEEPSLEEP state and is in state INIT or IDLE. At this time GPIO lines 5 and 6 are sampled and their values act to select the SPI mode.

See section 6 OPERATIONAL STATES AND POWER MANAGEMENT

When the DW1000 is put in SLEEP or DEEPSLEEP modes, the **SPI MISO is held low**. It is possible to share a SPI bus with the DW1000, in this case access to the other SPI slave would have to occur when the DW1000 is not in SLEEP or DEEPSLEEP.

5.8.2 SPI Signal Timing

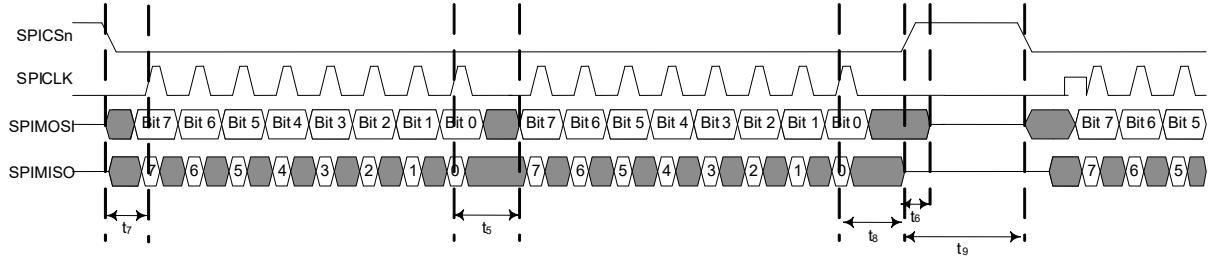

Figure 26: DW1000 SPI Timing Diagram

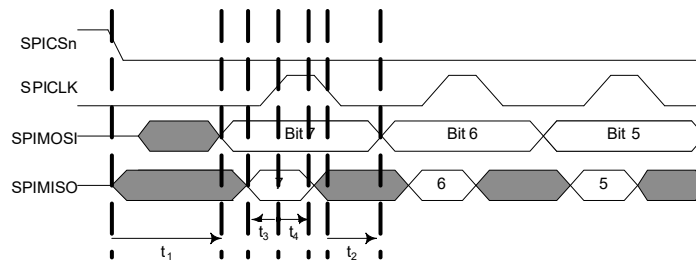

Figure 27: DW1000 SPI Detailed Timing Diagram

SPI transactions are initiated by the assertion of the active low chip select line, SPICSn. The high-to-low assertion (low) of SPICSn initialises the SPI transaction handler so that the DW1000 interprets the next octet(s) as a new transaction header. The low-to-high de-assertion of SPICSn ends the SPI transaction.

Note- The SPICSn should remain low for an entire SPI transaction. If the CSn goes high between octets, the transaction will be terminated where the CSn goes high and the next octet will be treated as a new transaction.

See the DW1000 User Manual [2] for further details on SPI transactions.

Table 18: DW1000 SPI Timing Parameters @ A) 125 MHz system clock and B) 19.2 MHz system clock

A:

Parameter	Min	Typ	Max	Unit	Description @ 125 MHz
SPICLK Period	50			ns	The maximum SPI frequency is 20 MHz when the CLKPLL is locked, otherwise the maximum SPI frequency is 3 MHz.
t ₁			38	ns	SPICSn select asserted low to valid slave output data
t ₂	12			ns	SPICLK low to valid slave output data
t ₃	10			ns	Master data output setup and hold time i.e Master data = MOSI
t ₄	10			ns	Master data output setup and hold time i.e Master data = MOSI
t ₅	32			ns	LSB last byte to MSB next byte
t ₆			10	ns	SPICSn de-asserted high to SPIMISO tri-state
t ₇	16			ns	Start time; time from select asserted to first SPICLK
t ₈	40			ns	Last SPICLK to SPICSn de-asserted
t ₉	40			ns	Idle time between consecutive accesses

B:

Parameter	Min	Typ	Max	Unit	Description @ 19.2 MHz
SPICLK Period	300			ns	The SPI will be clocked directly from the crystal when the PLL is not active or has not been switched in due to settling. The maximum SPI frequency is 3 MHz when the system is clocked from the crystal @19.6 MHz.
t ₁			210	ns	SPICSn select asserted low to valid slave output data
t ₂	55			ns	SPICLK low to valid slave output data
t ₃	10			ns	Master data output setup and hold time i.e Master data = MOSI
t ₄	10			ns	Master data output setup and hold time i.e Master data = MOSI
t ₅	205			ns	LSB last byte to MSB next byte
t ₆			55	ns	SPICSn de-asserted high to SPIMISO tri-state
t ₇	105			ns	Start time; time from select asserted to first SPICLK
t ₈	250			ns	Last SPICLK to SPICSn de-asserted
t ₉	250			ns	Idle time between consecutive accesses

5.9 General Purpose Input Output (GPIO)

The DW1000 provides 8 user-configurable I/O pins.

On reset, all GPIO pins default to input. GPIO inputs, when appropriately configured, are capable of generating interrupts to the host processor via the IRQ signal. Some GPIO lines have multiple functions as described in 2.2 above.

GPIO0, 1, 2, & 3, as one of their optional functions, can drive LEDs to indicate the status of various chip operations. Any GPIO line being used to drive an LED in this way should be connected as shown. GPIO5 & 6 are used to configure the operating mode of the SPI as described in 5.8.1. GPIO4, 5 & 6 may be optionally used to implement a scheme with an external power amplifier to provide a transmit power level in excess of that provided by the DW1000.

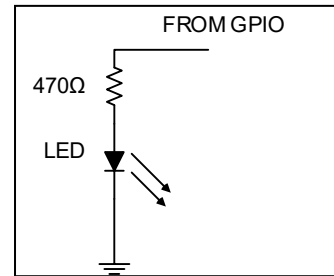

The DW1000 User Manual [2] provides details of the configuration and use of the GPIO lines.

5.10 Memory

The DW1000 includes a number of user accessible memories: -

5.10.1 Receive and Transmit data buffers

Buffers used to store received data to be read from the DW1000 by the host controller and data for transmission written into the DW1000 by the host controller. These are sized as follows: -

Table 19: Transmit & Receive Buffer Memory Size

Memory	Size (bits)	Description
Tx Buffer	1024 x 8	Transmit data buffer. Contains data written by the host processor to be transmitted via the transmitter
Rx Buffer	1024 x 8 x 2	Receive data buffer. Contains data received via the receiver to be read by the host processor via the SPI interface. Double buffered so that the receiver can receive a second packet while the first is being read by the host controller

5.10.2 Accumulator memory

The accumulator memory is used to store the channel impulse response estimate.

Table 20: Accumulator Memory Size

Memory	Size (bits)	Description
Accumulator	1016 x 32	Accumulator buffer. Used to store channel impulse response estimate data to be optionally read by the host controller

5.10.3 One Time Programmable (OTP) Calibration Memory

The DW1000 contains a small amount of user programmable OTP memory that is used to store per chip calibration information. When programming the OTP, the user should ensure that the VDDIO pins are supplied with 3.7 V minimum. If the VDDIO pin is unavailable, then the VDDIOA pin should be driven instead.

Table 21: OTP calibration memory

Memory	Size (bits)	Description
Calibration	56 x 32	One time programmable area of memory used for storing calibration data.

5.11 Interrupts and Device Status

DW1000 has a number of interrupt events that can be configured to drive the IRQ output pin. The default IRQ pin polarity is active high. A number of status registers are provided in the system to monitor and report data of interest. See DW1000 User Manual [2] for a full description of system interrupts and their configuration and status registers.

5.12 MAC Features

5.12.1 Timestamping

DW1000 generates transmit timestamps and captures receive timestamps. These timestamps are 40-bit values at a nominal 64 GHz resolution, for approximately 15 ps event timing precision. These timestamps enable ranging calculations.

DW1000 allows antenna delay values to be programmed for automatic adjustment of timestamps. See the DW1000 User Manual [2] for more details of DW1000 implementation and IEEE802.15.4-2011 [1] for details of definitions and required precision of timestamps and antenna delay values.

5.12.2 FCS Generation and Checking

DW1000 will automatically append a 2-byte FCS to transmitted frames and check received frames' FCS. The DW1000 can be used to send frames with a host-generated FCS, if desired.

5.12.3 Automatic Frame Filtering

Automatic frame filtering can be carried out using the DW1000. Incoming frames can be rejected automatically if they fail frame type or destination address checks. See the DW1000 User Manual [2] for details.

5.12.4 Automatic Acknowledge

The DW1000 can be configured to automatically acknowledge received frames requesting acknowledgement. See the DW1000 User Manual [2] for details.

Note that RX-TX turnaround is optimised for Automatic Acknowledge and is typically ~6.5 μ s, but depends on the configured frame parameters. The delay applied between frames is programmable in preamble symbol durations to allow compliance with standard SIFS and LIFS requirements.

5.12.5 Double Receive Buffer

The DW1000 has two receive buffers to allow the device to receive another frame whilst the host is accessing a previously received frame. Achievable throughput is increased by this feature. See the DW1000 User Manual [2] for details.

5.13 External Synchronization

The DW1000 provides a SYNC input. This allows: -

- Synchronization of multiple DW1000 timestamps.
- Transmission synchronous to an external reference.
- Receive timestamping synchronous to an external counter.

As shown in Figure 28 the SYNC input must be source synchronous with the external frequency reference. The SYNC input from the host system provides a common reference point in time to synchronise all the devices with the accuracy necessary to achieve high resolution location estimation.

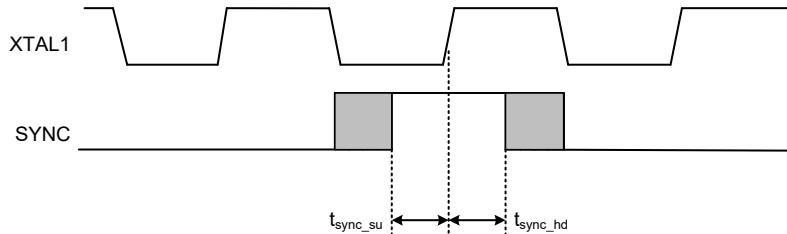

Figure 28: SYNC signal timing relative to XTAL1

Table 22: SYNC signal timing relative to XTAL

Parameter	Min	Typ	Max	Unit	Description
$t_{\text{SYNC_SU}}$	10			ns	SYNC signal setup time before XTAL1 rising edge
$t_{\text{SYNC_HD}}$	10			ns	SYNC signal hold time after XTAL1 rising edge

Further details on wired and wireless synchronization are available from Decawave.

5.14 Calibration and Spectral Tuning of the DW1000

5.14.1 Introduction

Depending on the end use application and the system design, certain internal settings in the DW1000 may need to be tuned. To help with this tuning a number of built in functions such as continuous wave TX and continuous packet transmission can be enabled. See the DW1000 User Manual [2] for further details on the sections described below.

5.14.2 Crystal Oscillator Trim

Minimising the carrier frequency offset between different DW1000 devices improves receiver sensitivity. The DW1000 allows trimming to reduce crystal initial frequency error. The simplest way to measure this frequency error is to observe the output of the transmitter at an expected known frequency using a spectrum analyser or frequency counter.

To adjust the frequency offset, the device is configured to transmit a CW signal at a particular channel frequency (e.g. 6.5 GHz). By accurately measuring the actual center frequency of the transmission the difference between it and the desired frequency can be determined. The trim value is then adjusted until the smallest frequency offset from the desired center frequency is obtained. Figure 29 gives the relationship between crystal trim code and crystal ppm offset.

If required, crystal trimming should be carried out on each DW1000 unit or module.

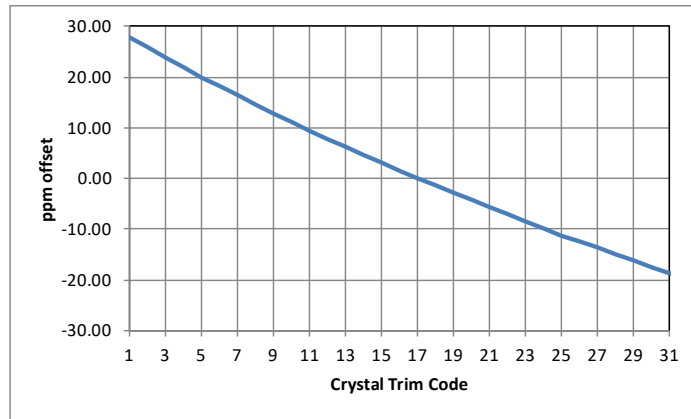

Figure 29: Typical Device Crystal Trim PPM Adjustment

The type of crystal used and the value of the loading capacitors will affect the crystal trim step size and the total trimming range. The total trim range and frequency step per trim code in ppm can be approximated using the following formula:

$$\text{Total trim range in ppm } Trim_Range = 10^6 \left[\frac{C_M}{2*(C_0+C_L+C_{TRIM})} \right] \left[\frac{C_{TRIM}}{C_L+C_{TRIM}} \right]$$

$$\text{Trim step size in ppm } Trim_Step = \frac{Trim_Range}{31}$$

Where C_M and C_0 are derived from the crystal model shown below, which is available from the crystal manufacturer. C_L is the external load capacitance including PCB parasitic and $C_{TRIM} = 7.75$ pF, which is the maximum internal trimming capacitance in DW1000.

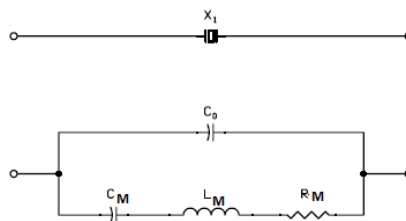

5.14.3 Transmitter Calibration

In order to maximise range DW1000 transmit power spectral density (PSD) should be set to the maximum allowable for the geographic region. For most regions this is -41.3 dBm/MHz.

The DW1000 provides the facility to adjust the transmit power in coarse and fine steps; 3 dB and 0.5 dB nominally. It also provides the ability to adjust the spectral bandwidth. These adjustments can be used to maximise transmit power whilst meeting regulatory spectral mask.

If required, transmit calibration should be carried out on each DW1000 PCB / module.

5.14.4 Antenna Delay Calibration

In order to measure range accurately, precise calculation of timestamps is required. To do this the antenna delay must be known. The DW1000 allows this delay to be calibrated and provides the facility to compensate for delays introduced by PCB, external components, antenna and internal DW1000 delays.

To calibrate the antenna delay, range is measured at a known distance using 2 DW1000 systems. Antenna delay is adjusted until the known distance and reported range agree. The antenna delay can be stored in OTP memory.

Antenna delay calibration must be carried out as a once off measurement for each DW1000 design implementation. If required, for greater accuracy, antenna delay calibration should be carried out on each DW1000 PCB / module.

6 OPERATIONAL STATES AND POWER MANAGEMENT

6.1 Overview

The DW1000 has a number of basic operating states as follows: -

Table 23: Operating States

Name	Description
OFF	The chip is powered down
INIT	This is the lowest power state that allows external micro-controller access. In this state the DW1000 host interface clock is running off the 38.4 MHz reference clock. In this mode the SPICLK frequency can be no greater than 3 MHz.
IDLE	In this state the internal clock generator is running and ready for use. The analog receiver and transmitter are powered down. Full speed SPI accesses may be used in this state.
DEEPSLEEP	This is the lowest power state apart from the OFF state. In this state SPI communication is not possible. This state requires an external pin to be driven (can be SPICSn held low or WAKEUP held high) for a minimum of 500 μ s to indicate a wake up condition. Once the device has detected the wake up condition, the EXTON pin will be asserted and internal reference oscillator (38.4 MHz) is enabled.
SLEEP	In this state it is possible for the DW1000 to wake up after a programmed sleep count. The low power oscillator is running and the internal sleep counter is active. The sleep counter allows for periods from approximately 300 ms to 450 hours before the DW1000 wakes up. In this state SPI communication is not possible. In this state it is also possible for an external pin to be driven (can be SPICSn held low or WAKEUP held high) for a minimum of 500 μ s to indicate a wake up condition. Once the device has detected the wake up condition, the EXTON pin will be asserted and internal reference oscillator (38.4 MHz) is enabled.
RX	The DW1000 is actively looking for preamble or receiving a packet
RX PREAMBLE SNIFF	In this state the DW1000 periodically enters the RX state, searches for preamble and if no preamble is found returns to the IDLE state. If preamble is detected it will stay in the RX state and demodulate the packet. Can be used to lower overall power consumption.
TX	The DW1000 is actively transmitting a packet

For more information on operating states please refer to the user manual [2].

6.2 Operating States and their effect on power consumption

The DW1000 can be configured to return to any one of the states, IDLE, INIT, SLEEP or DEEPSLEEP between active transmit and receive states. This choice has implications for overall system power consumption and timing, see table below.

Table 24: Operating States and their effect on power consumption

	DEVICE STATE				
	IDLE	INIT	SLEEP	DEEPSLEEP	OFF
Entry to State	Host controller command or previous operation completion	Host controller command	Host controller command or previous operation completion	Host controller command or previous operation completion	External supplies are off
Exit from State	Host controller command	Host controller command	Sleep counter timeout	SPICSn held low Or WAKEUP held high for 500 μ s	External 3.3 V supply on
Next state	Various	IDLE	INIT	INIT	INIT
Current Consumption	18 mA (No DC/DC) 12 mA (with DC/DC)	4 mA	1 μ A	50 nA	0
Configuration	Maintained	Maintained	Maintained	Maintained	Not maintained
Time before RX State Ready	Immediate	5 μ s	3 ms	3 ms	3 ms
Time before TX State Ready	Immediate	5 μ s	3 ms	3 ms	3 ms

In the SLEEP, DEEPSLEEP and OFF states, it is necessary to wait for the main on-board crystal oscillator to power up and stabilize before the DW1000 can be used. This introduces a delay of up to 3 ms each time the DW1000 exits SLEEP, DEEPSLEEP and OFF states.

6.3 Transmit and Receive power profiles

1. POWER OFF BETWEEN OPERATIONS

Configuration lost

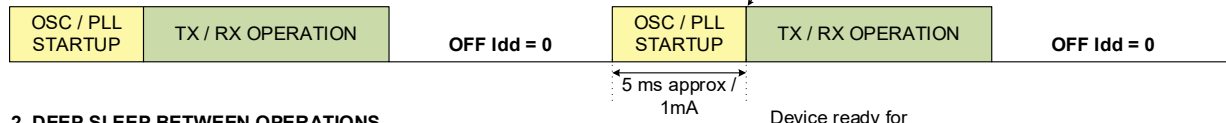

2. DEEP SLEEP BETWEEN OPERATIONS

Configuration retained

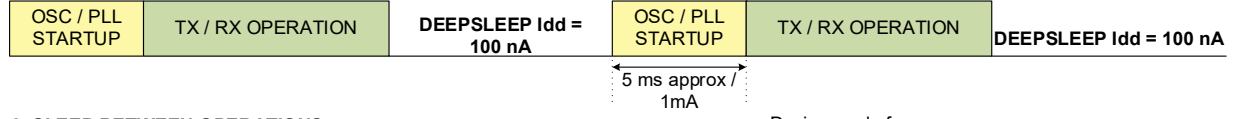

3. SLEEP BETWEEN OPERATIONS

Configuration retained

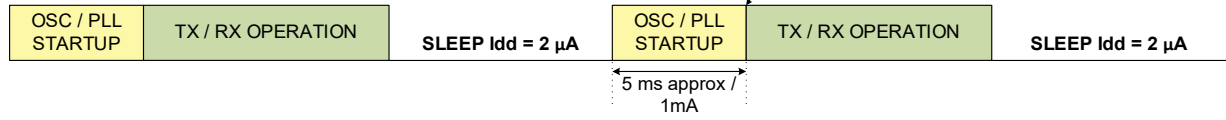

4. INIT STATE BETWEEN OPERATIONS

Configuration retained

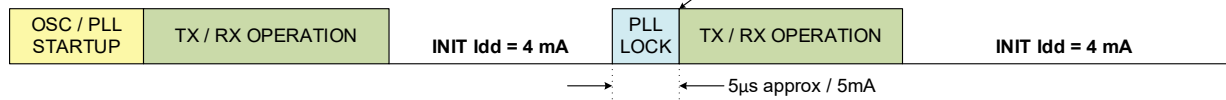

Figure 30: Sleep options between operations

The tables below show typical configurations of the DW1000 and their associated power profiles.

Table 25: Operational Modes

Example Setting	Data Rate	PRF (MHz)	Preamble (Symbols)	Data Length (Bytes)	Packet Duration (µs)	Typical Use Case (Refer to DW1000 user manual for further information)
A	110 kbps	16	1024	12	2443	RTLS, TDOA Scheme, Long Range, Low Density
B	6.8 Mbps	16	128	12	175	RTLS, TDOA Scheme, Short Range, High Density
C	110 kbps	16	1024	30	3625	RTLS, 2-way ranging scheme, Long Range, Low Density
D	6.8 Mbps	16	128	30	194	RTLS, 2-way ranging scheme, Short Range, High Density
E	6.8 Mbps	16	1024	1023	2250	Data transfer, Short Range, Long Payload
F	6.8 Mbps	16	128	127	312	Data transfer, Short Range, Short Payload
G	110 kbps	16	1024	1023	78258	Data transfer, Long Range, Long Payload
H	110 kbps	16	1024	127	11173	Data transfer, Long Range, Short Payload
I	110 kbps	64	1024	12	2469	As Mode 1 using 64 MHz PRF
J	6.8 Mbps	64	128	12	179	As Mode 2 using 64 MHz PRF
K	110 kbps	64	1024	30	3651	As Mode 3 using 64 MHz PRF
L	6.8 Mbps	64	128	30	197	As Mode 4 using 64 MHz PRF
M	6.8 Mbps	64	1024	1023	2275	As Mode 5 using 64 MHz PRF
N	6.8 Mbps	64	128	127	315	As Mode 6 using 64 MHz PRF
O	110 kbps	64	1024	1023	78284	As Mode 7 using 64 MHz PRF
P	110 kbps	64	1024	127	11199	As Mode 8 using 64 MHz PRF

Note: Other modes are possible

Table 26: Typical TX Current Consumption

Example Setting	TX I _{AVG} (mA)						Units
	Channel 2			Channel 5			
	Avg	Preamble	Data	Avg	Preamble	Data	
A	48	68	35	56	74	42	mA
B	68	68	50	69	74	57	mA
C	44	68	35	50	74	42	mA
D	60	68	51	67	74	58	mA
E	50	68	51	56	74	58	mA
F	56	68	51	62	74	58	mA
G	35	68	35	42	74	42	mA
H	38	68	35	44	74	42	mA
I	61	83	40	67	89	46	mA
J	79	83	52	85	89	59	mA
K	52	83	40	59	89	46	mA
L	75	83	52	82	89	59	mA
M	53	83	52	60	89	59	mA
N	65	83	52	72	89	59	mA
O	40	83	40	46	89	46	mA
P	43	83	40	50	89	46	mA

Table 27: Typical RX Current Consumption

Example Setting	RX I _{AVG} (mA)						Units
	Channel 2			Channel 5			
	Avg	Preamble	Data Demod	Avg	Preamble	Data Demod	
A	86	113	129	92	118	62	mA
B	115	113	118	122	118	123	mA
C	76	113	129	81	118	62	mA
D	115	113	115	123	118	123	mA
E	118	113	118	126	118	126	mA
F	113	113	113	125	118	126	mA
G	57	113	129	65	118	62	mA
H	62	113	129	70	118	62	mA
I	90	113	129	94	118	75	mA
J	112	113	118	117	118	123	mA
K	82	113	129	85	118	75	mA
L	112	113	118	118	118	123	mA
M	114	113	118	120	118	123	mA
N	113	113	118	119	118	123	mA
O	72	113	129	76	118	75	mA
P	76	113	129	80	118	75	mA

$T_{amb} = 25\text{ }^{\circ}\text{C}$, All supplies centered on typical values. All currents referenced to 3.3 V (VDDLDOA, VDDLDOA) supplies fed via a 1.6 V 90% efficient DC/DC converter)

From Table 25, Table 26 and Table 27 above it is clear that there is a trade-off between communications range and power consumption. Lower data rates allow longer range communication but consume more power. Higher data rates consume less power but have a reduced communications range.

For a given payload length, the following table shows two configurations of the DW1000. The first achieves minimum power consumption (not including DEEPSLEEP, SLEEP, INIT & IDLE) and the second achieves longest communication range.

Table 28: Lowest power and longest range modes of operation

Mode	Data Rate	Channel	PRF (MHz)	Preamble (Symbols)	Data Length (Bytes)	Rx PAC (Symbols)	Notes (Refer to DW1000 user manual for further information)
Lowest Power 2 options based on hardware configuration	6.8 Mbps with gating gain	1	16	64	As short as possible	8	Using 64 gearing tables
	6.8 Mbps with gating gain		16	128			Using "standard" gearing tables
Longest Range	110 Kbps		16	2048	All supported lengths	32	Using "tight" gearing tables and a TCXO as the source of the 38.4 MHz clock at each node

The graph below shows typical range and average transmitter current consumption per frame with the transmitter running at -41.3 dBm/MHz output power and using 0 dBi gain antennas for channel 2.

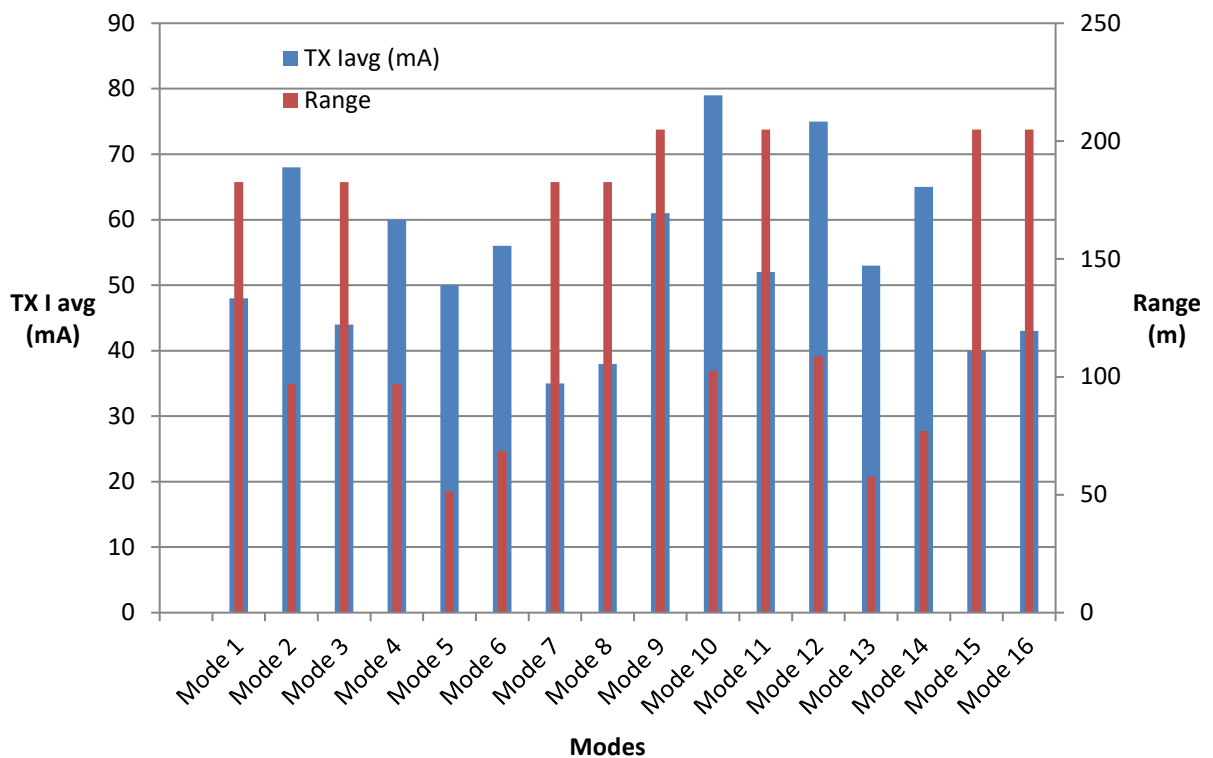

Figure 31: Typical Range versus TX average current (channel 2)

T_{amb} = 25 °C, All supplies centered on typical values. All currents referenced to 3.3 V (VDDLDOA, VDDLDOA) supplies fed via a 1.6 V 90% efficient DC/DC converter)

6.3.1 Typical transmit profile

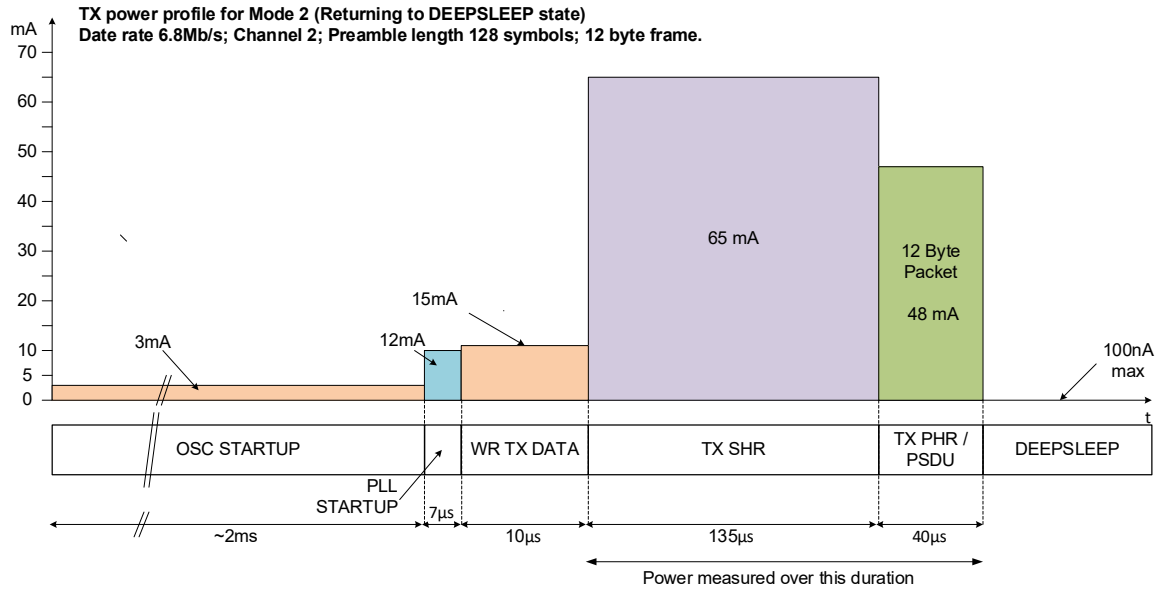

Figure 32: Typical TX Power Profile

6.3.2 Typical receive profiles

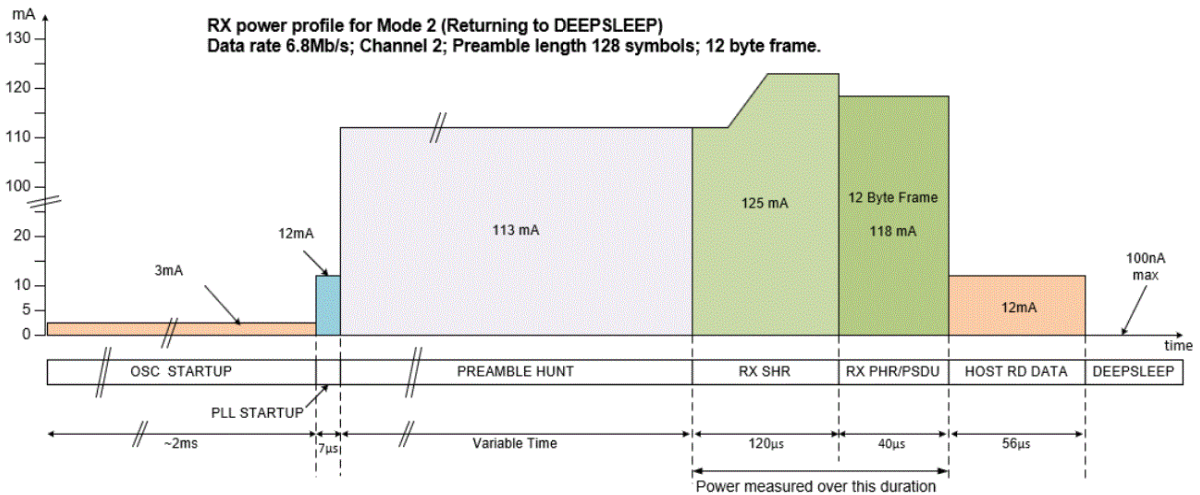

Figure 33: Typical RX Power Profile

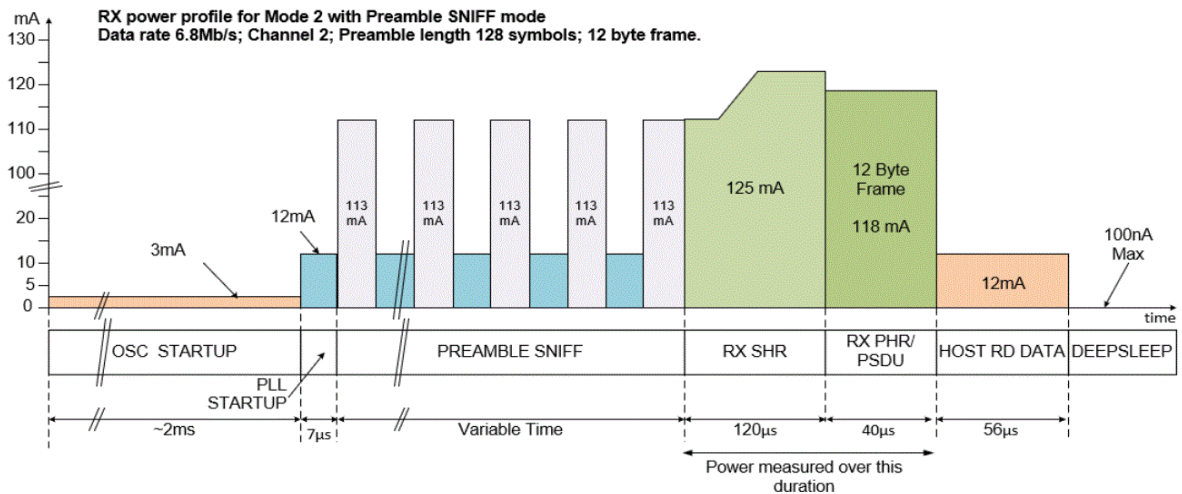

Figure 34: Typical RX Power Profile using SNIFF mode

7 POWER SUPPLY

7.1 Power Supply Connections

There are a number of different power supply connections to the DW1000.

The chip operates from a nominal 3.3 V supply. Some circuits in the chip are directly connected to the external 3.3 V supply. Other circuits are fed from a number of on-chip low-dropout regulators. The outputs of these LDO regulators are brought out to pins of the chip for decoupling purposes. Refer to Figure 35 for further details.

The majority of the supplies are used in the analog & RF section of the chip where it is important to maintain supply isolation between individual circuits to achieve the required performance.

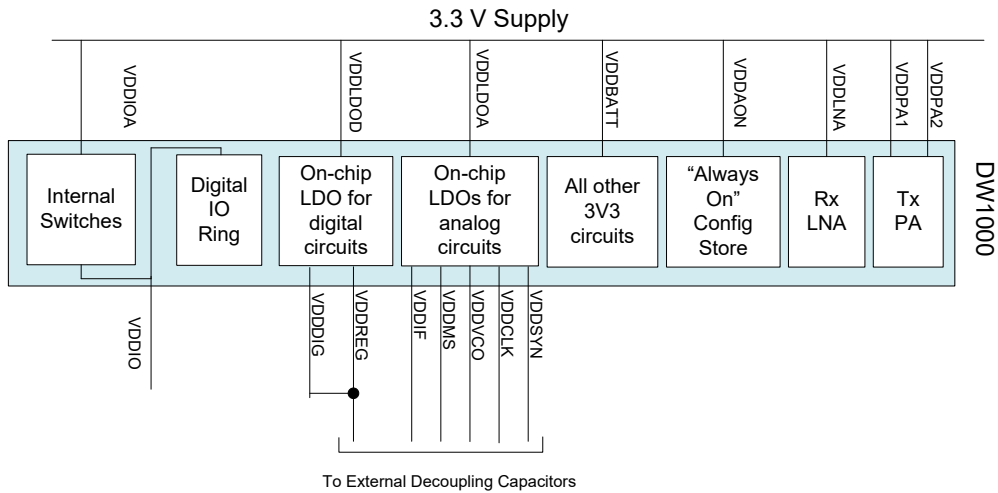

Figure 35: Power Supply Connections

7.2 Use of External DC / DC Converter

The DW1000 supports the use of external switching regulators to reduce overall power consumption from the power source. Using switching regulators can reduce system power consumption. The EXTON pin can be used to further reduce power by disabling the external regulator when the DW1000 is in the SLEEP or DEEPSLEEP states (provided the EXTON turn on time is sufficient).

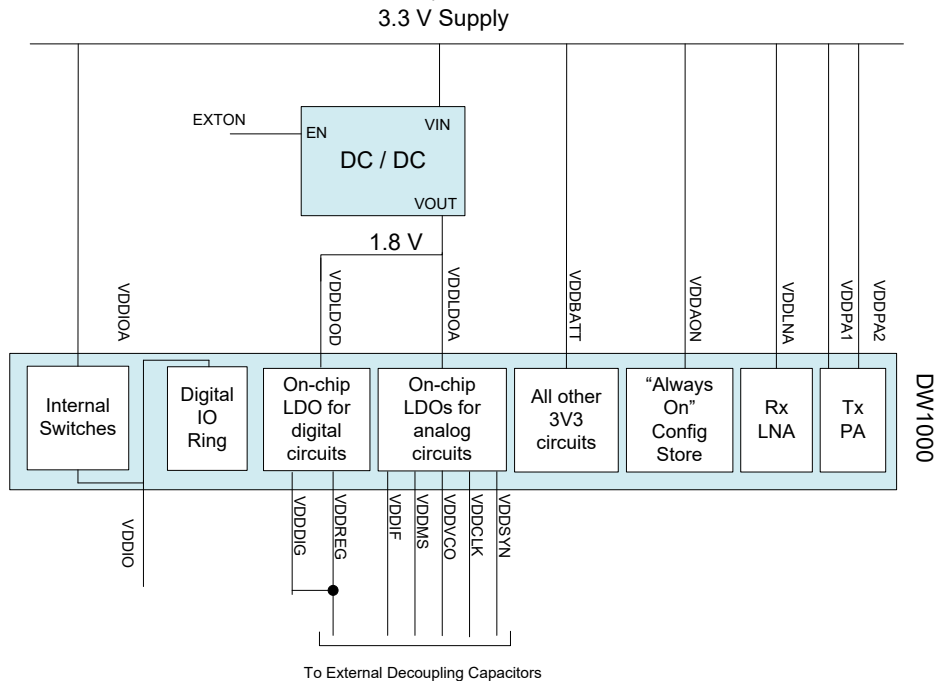

Figure 36: Switching Regulator Connection

7.3 Powering down the DW1000

The DW1000 has a very low DEEPSLEEP current (typ. 50 nA – see Table 3). The recommended practise is to keep the DW1000 powered up and use DEEPSLEEP mode when the device is inactive.

In situations where the DW1000 must be power-cycled (the 3.3 V supply in Figure 35 / Figure 36 respectively turned off and then back on), it is important to note that when power is removed the supply voltage will decay towards 0 V at a rate determined by the characteristics of the power source and the amount of decoupling capacitance in the system.

In this scenario, power should only be reapplied to the DW1000 when: -

- VDDAON is above 2.3 V or:
- VDDAON has fallen below 100 mV

Reapplying power while VDDAON is between 100 mV and 2.3 V can lead to the DW1000 powering up in an unknown state which can only be recovered by fully powering down the device until the voltage on VDDAON falls below 100 mV.

8 APPLICATION INFORMATION

8.1 Application Circuit Diagram

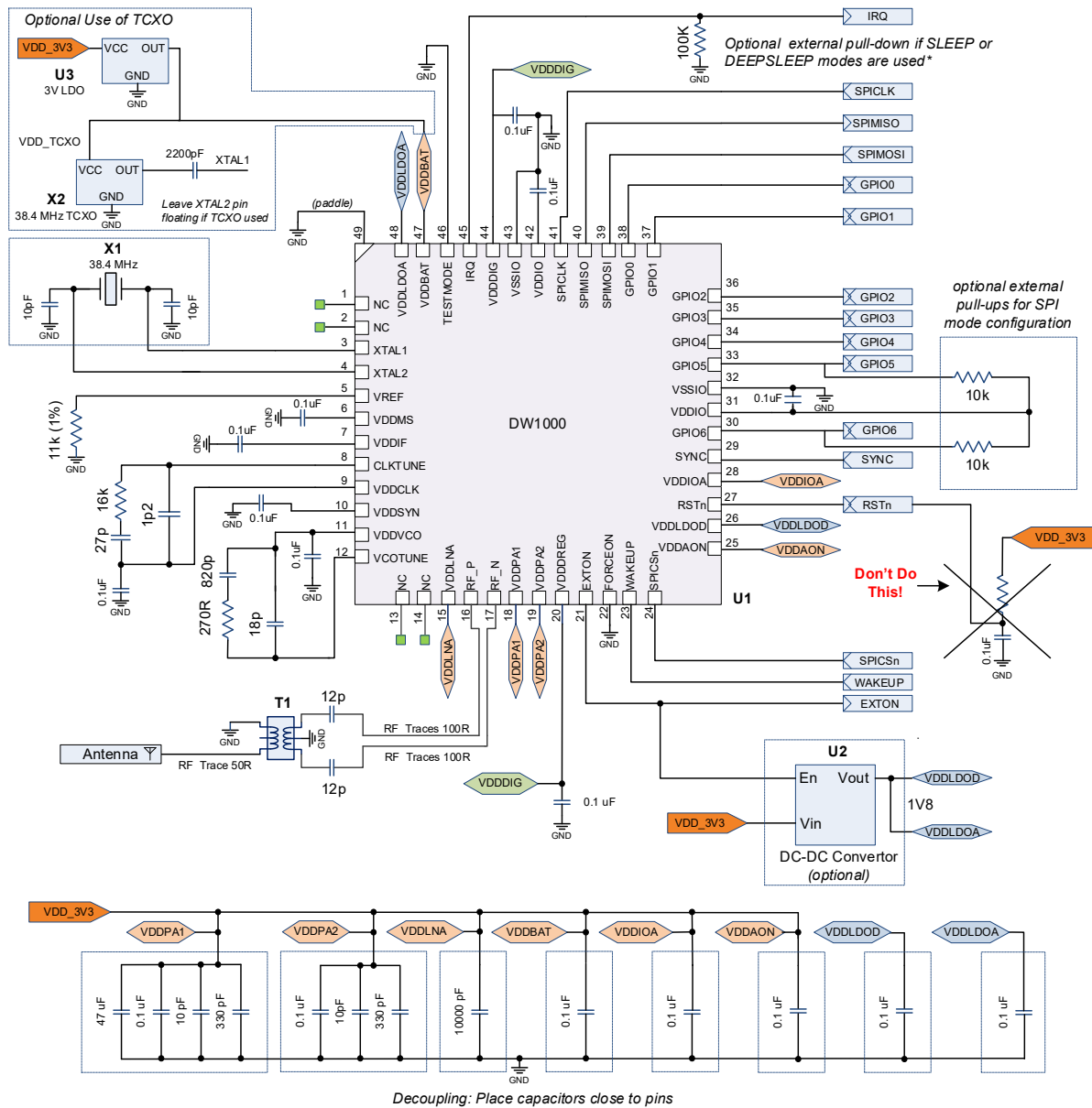

Figure 37: DW1000 Application Circuit

*The external pull-down is not required if the connected MCU has an internal MCU pull-down

8.2 Recommended Components

Function	Manufacturer	Part No	Ref	Web Link
Antenna	Partron	ACS5200HFAUWB		www.partron.co.kr
	Taiyo Yuden	AH086M555003		www.yuden.co.jp
SMT UWB Balun 3-8 GHz	TDK Corporation	HHM1595A1	T1	www.tdk.co.jp
	STMicroelectronics	BAL-UWB-01E3	T1	www.st.com
Capacitors (Non polarized)	Murata	GRM155 series		www.murata.com
	KEMET	C0805C476M9PACTU	47 μ F	www.kemet.com
Crystal (38.4 MHz +/- 10ppm)	TXC	8Y38472012	X1	www.txccorp.com
	Abracon	ABM10-165-38.400MHZ-T3		www.abracon.com
	Geyer	KX-5T (need to request tight tolerance option)		www.geyer-electronic.de
	Rakon	HDD10RSX-10 509344		www.rakon.com
	Note that the crystal loading caps must be selected according to the crystal manufacturer's recommendation and your PCB design so as to place the nominal crystal oscillation frequency in the centre of the DW1000 crystal trim range. The values given in Figure 37 above are for example purposes only and may not apply to your design.			
DC/DC 3V3	Torex	XC9258B33CER-G	VDD_3V3	www.torexsemi.com
DC/DC 1V8	Torex	XC9282B18E0R-G-ND	U2	www.torexsemi.com
		XCL222B181ER-G		
		XC9258B18CER-G		
	Texas Instruments	LM3671TL-1.8/NOPB		www.ti.com
Resistors	ROHM	MCR01MZPF		www.rohm.com
TCXO (optional use in Anchor nodes. 38.4 MHz)	TXC	7Z38470005	X2	www.txccorp.com
	Abracon	ASTXR-12-38.400MHZ-514054-T		www.abracon.com
	Geyer	KXO-84		www.geyer-electronic.de
	Rakon	IT2200K 3.3V 38.4MHz		www.rakon.com

8.3 Application Circuit Layout

8.3.1 PCB Stack

The following 4-layer PCB stack up is one suggested stack up which can be used to achieve optimum performance.

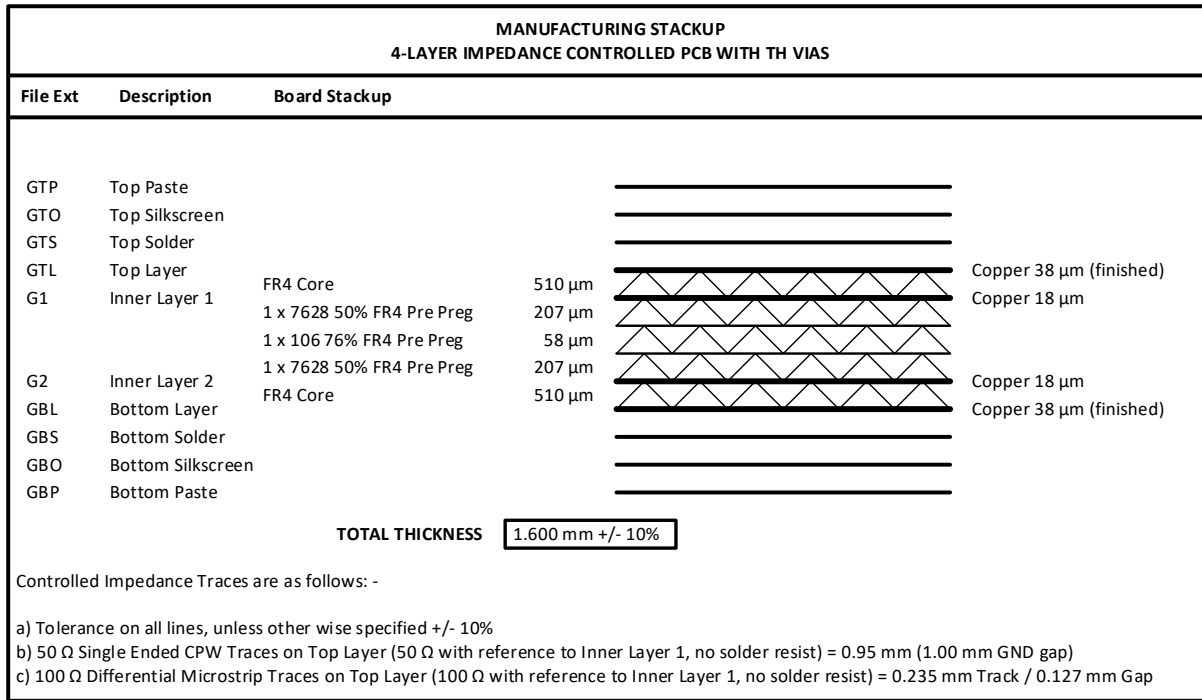

Figure 38: PCB Layer Stack for 4-layer board

8.3.2 RF Traces

As with all high frequency designs, particular care should be taken with the routing and matching of the RF sections of the PCB layout. All RF traces should be kept as short as possible and where possible impedance discontinuities should be avoided. Where possible RF traces should cover component land patterns.

Poor RF matching of signals to/from the antenna will degrade system performance. A $100\ \Omega$ differential impedance should be presented to the RF_P and RF_N pins of DW1000 for optimal performance. This can be realised as either $100\ \Omega$ differential RF traces or as 2 single-ended $50\ \Omega$ traces depending on the PCB layout. In most cases a single-ended antenna will be used and a wideband balun will be required to convert from $100\ \Omega$ differential to $50\ \Omega$ single-ended.

Figure 39 gives an example of a suggested RF section layout. In this example traces to the $12\ \text{pF}$ series capacitors from the RF_P and RF_N pins are realised as $100\ \Omega$ differential RF traces referenced to inner layer 1. After the $12\ \text{pF}$ capacitors the traces are realised as $50\ \Omega$ micro-strip traces again referenced to inner layer 1. Using this method, thin traces can be used to connect to DW1000 and then wider traces can be used to connect to the antenna.

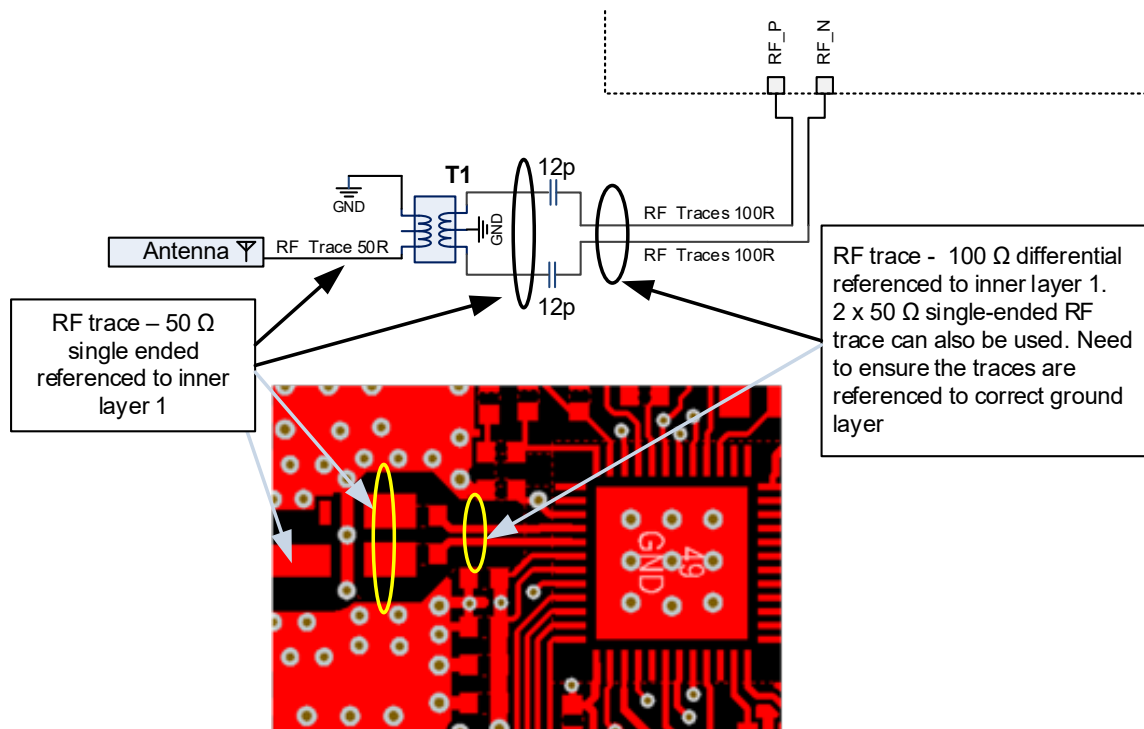

Figure 39: DW1000 RF Traces Layout

8.3.3 PLL Loop Filter Layout

The components associated with the loop filters of the on-chip PLLs should be placed as close as possible to the chip connection pins to minimize noise pick-up on these lines.

8.3.4 Decoupling Layout

All decoupling capacitors should be kept as close to their respective pins of the chip as possible to minimize trace inductance and maximize their effectiveness.

8.3.5 Layout Guidance

An application note is available from Decawave together with a set of DXF files to assist customers in reproducing the optimum layout for the DW1000.

PCB land-pattern libraries for the DW1000 are available for the most commonly used CAD packages.

Contact Decawave for further information.

9 PACKAGING & ORDERING INFORMATION

9.1 Package Dimensions

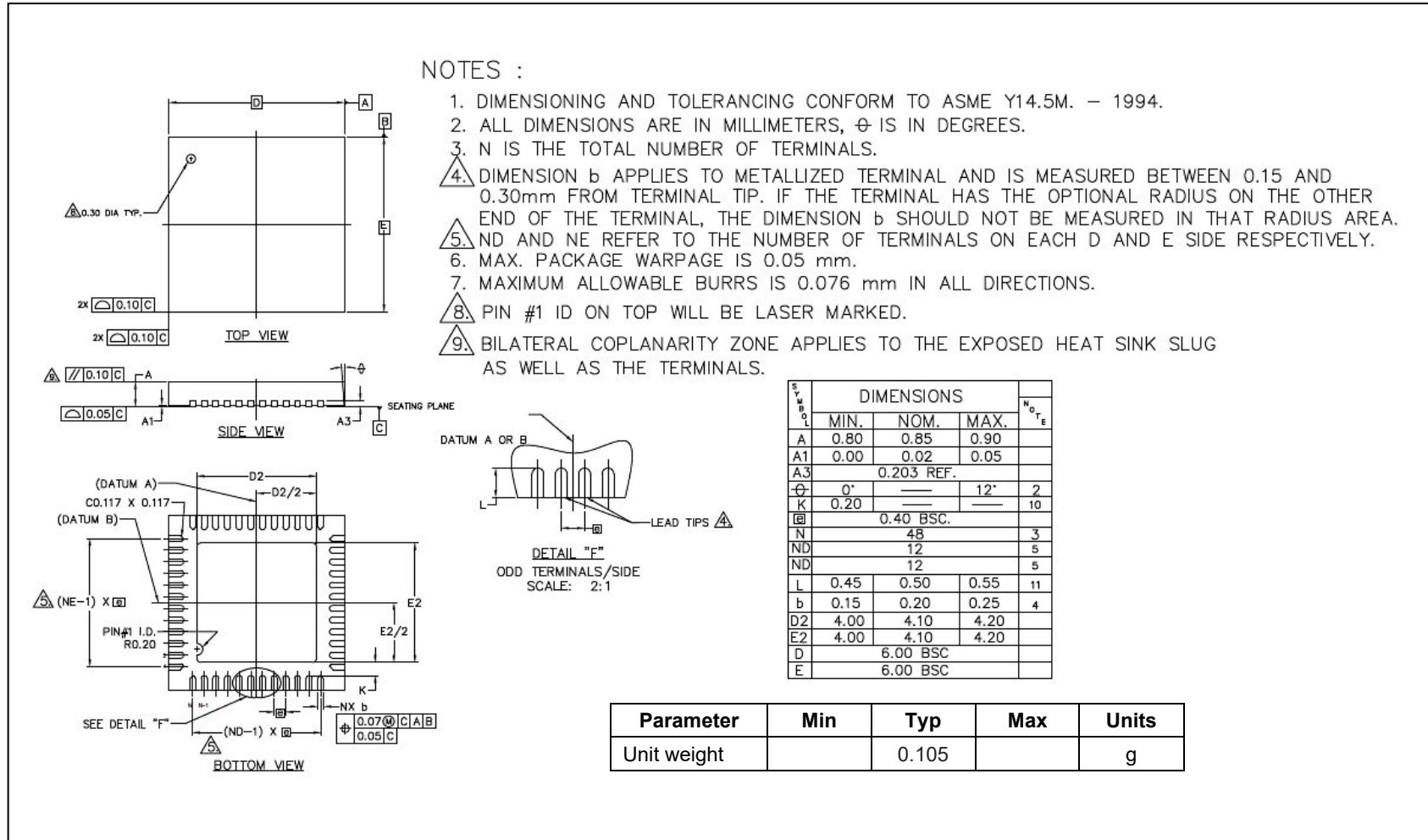

Figure 40: Device Package mechanical specifications

9.2 Device Package Marking

The diagram below shows the package markings for DW1000.

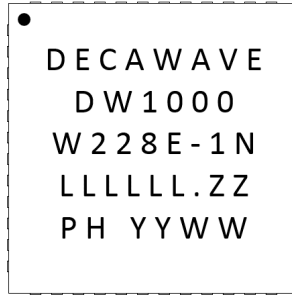

Figure 41: Device Package Markings

Legend:

W228E-1N	7 digit manufacturing code
LLLLLL	6 digit lot ID
ZZ	2 digit lot split number
PH	Assembly location
YY	2 digit year number
WW	2 digit week number

9.3 Tray Information

The general orientation of the 48QFN package in the tray is as shown in Figure 42.

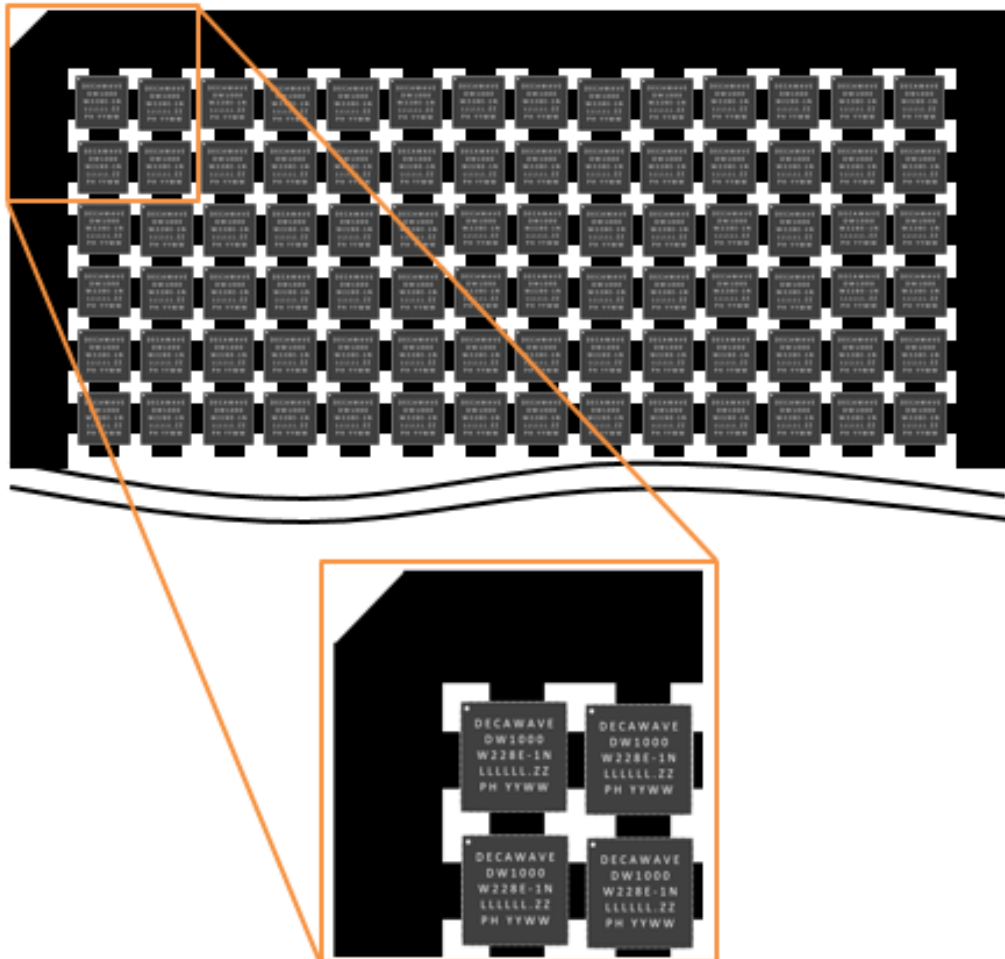

Figure 42: Tray Orientation

The white dot marking in the chip's top left hand corner aligns with the chamfered edge of the tray.

9.4 Tape & Reel Information

9.4.1 Important note

The following diagrams and information relate to reel shipments made from 23rd March 2015 onwards. Information relating to reels shipped prior to that date may be obtained from Decawave.

9.4.2 Tape Orientation and Dimensions

The general orientation of the 48QFN package in the tape is as shown in Figure 43.

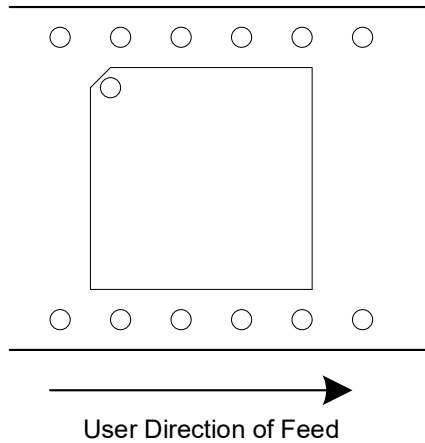
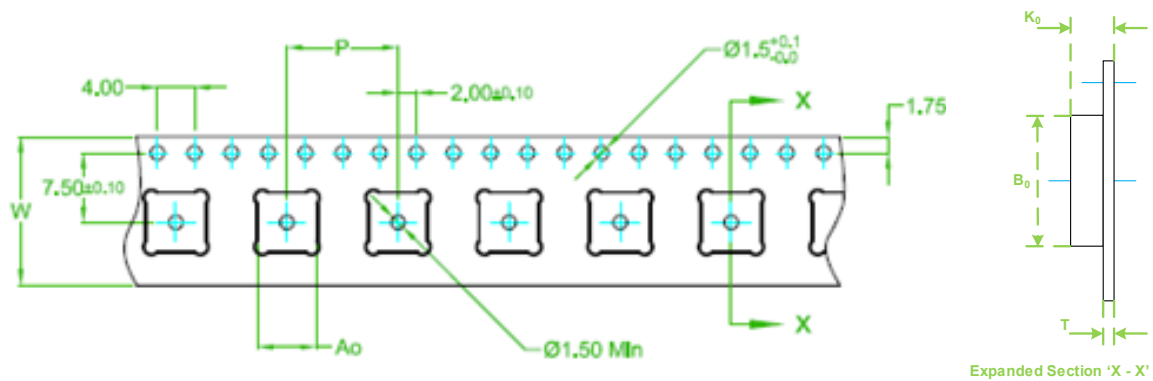

Figure 43: Tape & Reel orientation



Dimensions	Values	Notes
Ao	6.3 ± 0.1	All dimensions in mm sprocket hole pitch cumulative tolerance ± 0.20 Material: Conductive Polystyrene Camber not to exceed 1.0 mm in 250 mm
Bo	6.3 ± 0.1	
Ko	1.1 ± 0.1	
P	12.00 ± 0.1	
T	0.30 ± 0.05	
W	16.00 + 0.30 – 0.10	

Figure 44: Tape dimensions

9.4.3 Reel Information: 330 mm Reel

Base material: High Impact Polystyrene with Integrated Antistatic Additive
 Surface resistivity: Antistatic with surface resistivity less than 1×10^{12} Ohms per square

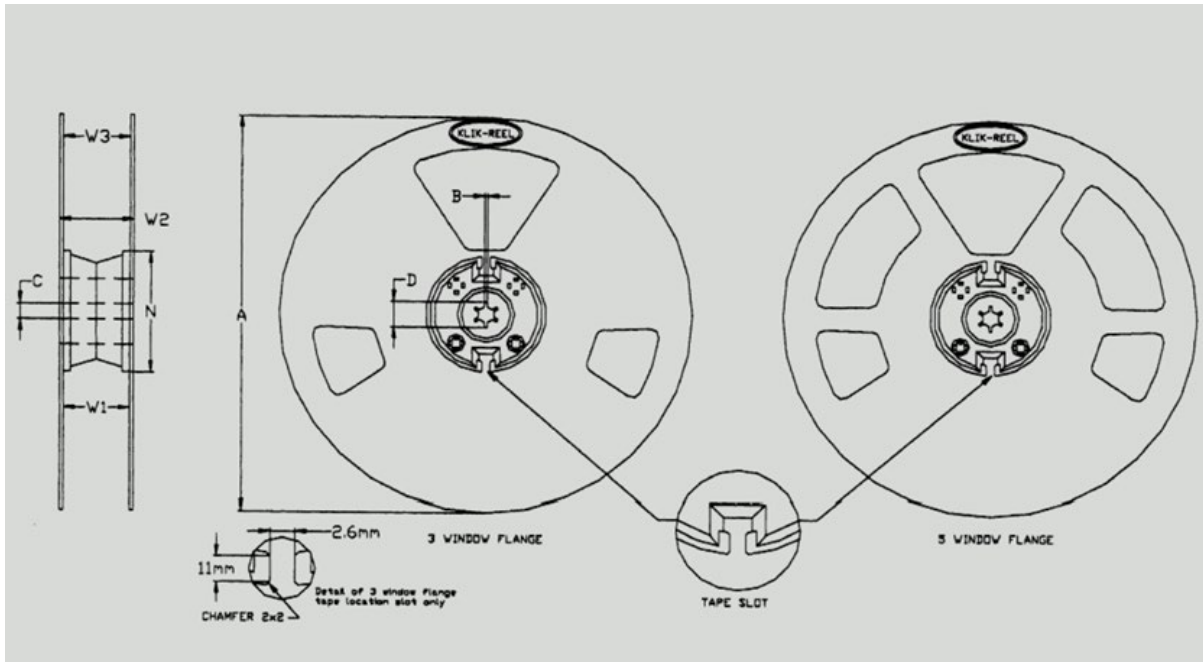

Tape Width	A Diameter	B (min)	C	D (min)	N Hub	W1	W2 (max)	W3 (min)	W4 (max)
16	330 / 380	1.5	13 + 0.5 - 0.2	20.2	100 / 150 +/- 1 mm	16.4 + 2.0 - 0.0	22.4	15.9	19.4

Figure 45: 330 mm reel dimensions

All dimensions and tolerances are fully compliant with EIA- 481-C and are specified in millimetres. There are 4000 pieces per reel.

9.5 Reflow profile

The DW1000 should be soldered using the reflow profile specified in JEDEC J-STD-020 as adapted for the particular PCB onto which the IC is being soldered.

9.6 Ordering Information

The standard qualification for the DW1000 is industrial temperature range: -40 °C to +85 °C, packaged in a 48-pin QFN package.

Table 29: Device ordering information

Ordering Codes:

High Volume

Ordering code	Status	Package Type	Package Qty	Note
DW1000-I	Active	Tray	490	Available
DW1000-ITR13	Active	Tape & Reel	4000	Available

Samples

Ordering Code	Status	Package Type	Package Qty	Note
DW1000-I	Active	Tray	10-490	Available
DW1000-ITR13	Active	Tape & Reel	100 – 4000	Available

All IC's are packaged in a 48-pin QFN package which is Pb free, RoHS, Green, NiPd lead finish, MSL level 3 IC Operation Temperature -40 °C to +85 °C.

10 GLOSSARY

Table 30: Glossary of Terms

Abbreviation	Full Title	Explanation
EIRP	Equivalent Isotropically Radiated Power	The amount of power that a theoretical isotropic antenna (which evenly distributes power in all directions) would emit to produce the peak power density observed in the direction of maximum gain of the antenna being used.
ETSI	European Telecommunication Standards Institute	Regulatory body in the EU charged with the management of the radio spectrum and the setting of regulations for devices that use it
FCC	Federal Communications Commission	Regulatory body in the USA charged with the management of the radio spectrum and the setting of regulations for devices that use it.
FFD	Full Function Device	Defined in the context of the IEEE802.15.4-2011 standard.
GPIO	General Purpose Input / Output	Pin of an IC that can be configured as an input or output under software control and has no specifically identified function.
IEEE	Institute of Electrical and Electronic Engineers	Is the world's largest technical professional society. It is designed to serve professionals involved in all aspects of the electrical, electronic and computing fields and related areas of science and technology.
LIFS	Long Inter-Frame Spacing	Defined in the context of the IEEE802.15.4-2011 standard.
LNA	Low Noise Amplifier	Circuit normally found at the front-end of a radio receiver designed to amplify very low level signals while keeping any added noise to as low a level as possible
LOS	Line of Sight	Physical radio channel configuration in which there is a direct line of sight between the transmitter and the receiver.
Open Drain	Open Drain	A technique allowing a signal to be driven by more than one device. Generally, each device is permitted to pull the signal to ground but when not doing so it must allow the signal to float. Devices should not drive the signal high so as to prevent contention with devices attempting to pull it low.
NLOS	Non Line of Sight	Physical radio channel configuration in which there is no direct line of sight between the transmitter and the receiver.
PGA	Programmable Gain Amplifier	Amplifier whose gain can be set / changed via a control mechanism usually by changing register values.
PLL	Phase Locked Loop	Circuit designed to generate a signal at a particular frequency whose phase is related to an incoming "reference" signal.
PPM	Parts Per Million	Used to quantify very small relative proportions. Just as 1% is one out of a hundred, 1 ppm is one part in a million.
RF	Radio Frequency	Generally used to refer to signals in the range of 3 kHz to 300 GHz. In the context of a radio receiver, the term is generally used to refer to circuits in a receiver before down-conversion takes place and in a transmitter after up-conversion takes place.
RFD	Reduced Function Device	Defined in the context of the IEEE802.15.4-2011 [1] standard.
RTLS	Real Time Location System	System intended to provide information on the location of various items in real-time.
SFD	Start of Frame Delimiter	Defined in the context of the IEEE802.15.4-2011 standard.
SIFS	Short Inter-Frame Spacing	Defined in the context of the IEEE802.15.4-2011 standard.
SPI	Serial Peripheral Interface	An industry standard method for interfacing between IC's using a synchronous serial scheme first introduced by Motorola.
TCXO	Temperature Controlled Crystal Oscillator	A crystal oscillator whose output frequency is very accurately maintained at its specified value over its specified temperature range of operation.
TWR	Two Way Ranging	Method of measuring the physical distance between two radio units by exchanging messages between the units and noting the times of transmission and reception. Refer to Decawave's website for further information.
TDOA	Time Difference of Arrival	Method of deriving information on the location of a transmitter. The time of arrival of a transmission at two physically different locations whose clocks are synchronized is noted and the difference in the arrival times provides information on the location of the transmitter. A number of such TDOA measurements at different locations can be used to uniquely determine the position of the transmitter. Refer to Decawave's website for further information.
UWB	Ultra Wideband	A radio scheme employing channel bandwidths of, or in excess of, 500 MHz.
WSN	Wireless Sensor Network	A network of wireless nodes intended to enable the monitoring and control of the physical environment.

11 REFERENCES

- [1] IEEE802.15.4-2011 or “IEEE Std 802.15.4™-2011” (Revision of IEEE Std 802.15.4-2006). IEEE Standard for Local and metropolitan area networks – Part 15.4: Low-Rate Wireless Personal Area Networks (LR-WPANs). IEEE Computer Society Sponsored by the LAN/MAN Standards Committee. Available from <http://standards.ieee.org/>
- [2] Decawave DW1000 User Manual
- [3] www.etsi.org
- [4] www.fcc.gov
- [5] EIA-481-C Standard
- [6] APH010 DW1000 inter channel interference

12 DOCUMENT HISTORY

Table 31: Document History

Revision	Date	Description
2.00	7 th November 2012	Initial release for production device.
2.01	31 st March, 2014	Scheduled update
2.02	8 th July 2014	Scheduled update
2.03	30 th September 2014	Scheduled update
2.04	31 st December 2014	Scheduled update
2.05	31 st March 2015	Scheduled update
2.06	30 th June 2015	Scheduled update
2.07	30 th September 2015	Scheduled update
2.08	31 st December 2015	Scheduled update
2.09	31 st March 2016	Scheduled update
2.10	30 th June 2016	Scheduled update
2.11	30 th September 2016	Scheduled update
2.12	30 th December 2016	Scheduled update
2.13	30 th April 2017	Scheduled update
2.14	1 st august 2017	Scheduled update
2.15	18 th December 2017	Scheduled update
2.16	30 th April 2018	Scheduled update
2.17	30 th August 2018	Scheduled update
2.18	28 th January 2019	Scheduled update
2.19	7 th June 2019	Scheduled update
2.20	15 th Dec 2019	Scheduled update
2.21	1 st April 2020	Scheduled update
2.22	29 th May 2020	Scheduled update

13 MAJOR CHANGES

Revision 2.03

Page	Change Description
All	Update of version number to 2.03
All	Various typographical changes
15	Modification to figure 11 caption
21	Addition of text relating to use of RSTn as indicator to external μ controller
35	Change to application schematic to modify value of TCXO coupling capacitor
36	Correction of Rakon TCXO part number
44	Addition of v2.03 to revision history table Addition of this table and section heading Modification of heading format on this page only

Revision 2.04

Page	Change Description
All	Update of version number to 2.04
All	Various typographical changes
2	Update of table of contents
23	Modification of SPI timing diagrams figure 25 & 26 to correct timing definitions
33	Addition of section 7.3 re power down
37	Change of page orientation to landscape to expand figure 39 for legibility
43	Corrections to v2.03 change table Addition of v2.04 to revision history table Addition of this table
43	Removal of page breaks in heading numbers 11, 12, 13 and 14

Revision 2.05

Page	Change Description
All	Update of version number to 2.05
2	Update to table of contents
4	Modification of copyright notice to 2015
11	Modifications to Table 6 re Rx sensitivity conditions and Table 7 re recommended TCXO coupling capacitor value
20	Update to Figure 20 and Table 15 to further clarify power up timings
21	addition of Figure 21 to further clarify power up timings
23	Addition to heading of Table 16
34	Addition of clarification re power supplies that should be removed to power down the chip
38	Addition of device weight to Figure 40
44	Addition of v2.05 to revision history table
45	Addition of this table

Revision 2.06

Page	Change Description
All	Update of version number to 2.06
All	Various typographical / formatting changes
1	Addition of pin pitch / Update to SLEEP current & DEEPSLEEP current
2	Update to table of contents
10	Addition to table 3 to indicate max digital input voltage
37	Modification to figure 39 to clarify referenced layers for impedance matching purposes

40 – 41	Changes to tape and reel drawings NOTE CHANGE IN QFN ORIENTATION vs. FEED DIRECTION
44	Addition of v2.06 to revision history table
45	Addition of this table

Revision 2.07

Page	Change Description
All	Update of version number to 2.07
All	Various typographical / formatting changes
35 – 36	Addition of Abracon parts to “Recommended Components” table
44	Addition of v2.07 to revision history table
45	Addition of this table

Revision 2.08

Page	Change Description
All	Update of version number to 2.08
All	Various typographical / formatting changes
10	Update to typ current values for INIT & IDLE states
35	Figure 37: Addition of decoupling caps on VDDLDOA and VDDLDOB
37	Clarification of reference layers in Figure 38
44	Addition of v2.08 to revision history table
45	Addition of this table

Revision 2.09

Page	Change Description
All	Update of version number to 2.09
All	Various typographical / formatting changes
20	Modifications to description of power up sequence in section 5.6 to clarify use and control of RSTn including addition of new section 5.6.3 and new Table 16
36	Modification to Figure 38 to correct impedance reference layer from 2 to 1
37	Modification to Figure 37 to include external LDO for TCXO
44	Addition of 2.09 to Table 31
46	Addition of this Table

Revision 2.10

Page	Change Description
All	Update of version number to 2.10
All	Various typographical / formatting changes
7	Correction of pinout functionality for GPIO5 & 6 in Figure 2
8	Correction of pinout functionality for GPIO5 & 6 in Table 1
8	Addition of explanatory text to GPIO and WAKEUP pins in Table 1
39	Modifications to Figure 41 to reflect actual device markings
39	Modification to Figure 42 to reflect actual device markings
42	Addition of section 9.5 dealing with reflow soldering profile
42	Change of numbering of previous section 9.5 to 9.6
44	Addition of 2.10 to Table 31
46	Addition of this Table

Revision 2.11

Page	Change Description
All	Update of version number to 2.11
36	Modification to Figure 37 to remove 4.7 uF capacitor on VDDLDOA
37	Addition of DCDC converter part to recommended components table
46	Addition of 2.11 to Table 31
48	Addition of this Table

Revision 2.12

Page	Change Description
All	Update of version number to 2.12
28	Extended description of the SLEEP state and methods of exiting it.
35	Abracon added as current antenna manufacturer

Revision 2.13

Page	Change Description
All	Update of version number to 2.13
6	Updated XTAL2 pin description in Table 1
18	Update Table 18, PHR is 21 Symbols, was shown as 21bits
24	Updated SPI timings, split spec for 125MHz and 19.2MHz system clock
20	Table 25 Operational Modes updated
36	Text added to Figure 37 describing treatment of XTAL2 pin if TCXO used
47	Addition of this table

Revision 2.14

Page	Change Description
All	Update of version number to 2.14
30,31	Updates to column 1 of Table 26 and 27, to match A,B,C of Table 25
31	Updates to current issues in table 27 to match that achievable with released API.
36	Fig 37 updated to correctly name VDDPA1 and VDDPA2
48	Addition of this table

Revision 2.15

Page	Change Description
All	Update of version number to 2.15
24	Explain SPI transactions
37	Update recommended components
32	Update table 28
48	Addition of this table

Revision 2.16

Page	Change Description
ALL	Logo Change

Revision 2.17

Page	Change Description
18	Update section to warn about possible channel interference
37	Removed Abracon antenna ACA-107 as it is no longer available

Revision 2.18

Page	Change Description
23 & 24	Restriction on SPI MISO pin usage in sleep mode
24 & 25	SPI timing values t ₈ and t ₉ swapped to match timing diagram in table 18 (A) and (B)

Revision 2.19

Page	Change Description
8	Removed reference to LEDs in Digital Decoupling
27	Removed Parton TCXO (EOL), added ST Balun and added TOREX and TI DC/DC
33	Typical power in Fig 32, 33 & 34 updated

Revision 2.20

Page	Change Description
6	Update to EXTON pin description, when not used it can be left floating
38	Explanation included when there is no need to use pull-down resistor for IRQ (pin 45)
26	Update of timing parameters t ₃ and t ₄
38	Updated list of recommended components
ALL	Removed repetition of IEEE802.15.4-2011 [1]

Revision 2.21

Page	Change Description
11	Description of in-band and out-band added

Revision 2.22

Page	Change Description
39	Update TXC address
46	Removal of 180mm reel information as no longer supported per PCN 1741
All	Logo update for Qorvo



14 FURTHER INFORMATION

Decawave develops semiconductors solutions, software, modules, reference designs - that enable real-time, ultra-accurate, ultra-reliable local area micro-location services. Decawave's technology enables an entirely new class of easy to implement, highly secure, intelligent location functionality and services for IoT and smart consumer products and applications.







For further information on this or any other Decawave product, please refer to our website www.decawave.com.

Looking for pricing, stock, or lifecycle information?

Click below to explore more details on WIN SOURCE:

-  [View DW1000-I-TR13 on WIN SOURCE](#)
-  [Decawave Limited Information](#)

Optimize Your Supply Chain with WIN SOURCE Solutions

-  Global Sourcing Solution
-  Obsolete Management
-  Cost Control Management
-  Shortage Management
-  Alternative Solution
-  Excess Inventory Management