



**THE DATASHEET OF
SP485RCP-L**



1/10th Unit Load RS-485 Transceiver

FEATURES

- Allows Over 400 Transceivers On A Transmission Line (1/10th Unit Load)
- High Impedance on Receiver Inputs ($R_{IN} = 150k\Omega$ typical)
- Half-Duplex Configuration Consistent With Industry Standard Pinout
- -7V to +12V Common Mode Input Voltage Range
- Low Power Consumption (250mW)
- Separate Driver and Receiver Enable

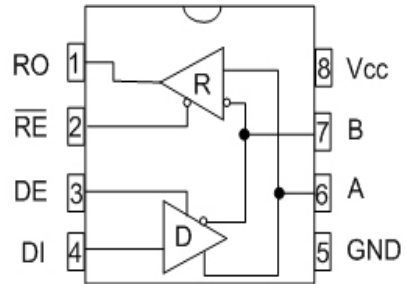

SP485R
Pinout (Top View)

DESCRIPTION

The **SP485R** is a pin-to-pin equivalent to our existing SP485 product and offers a high receiver input impedance. The higher receiver input impedance allows for connecting over 400 transceivers on a single transmission line without degrading the RS-485 driver signal. The device is packaged in a 8-pin plastic DIP or 8-pin narrow SOIC.

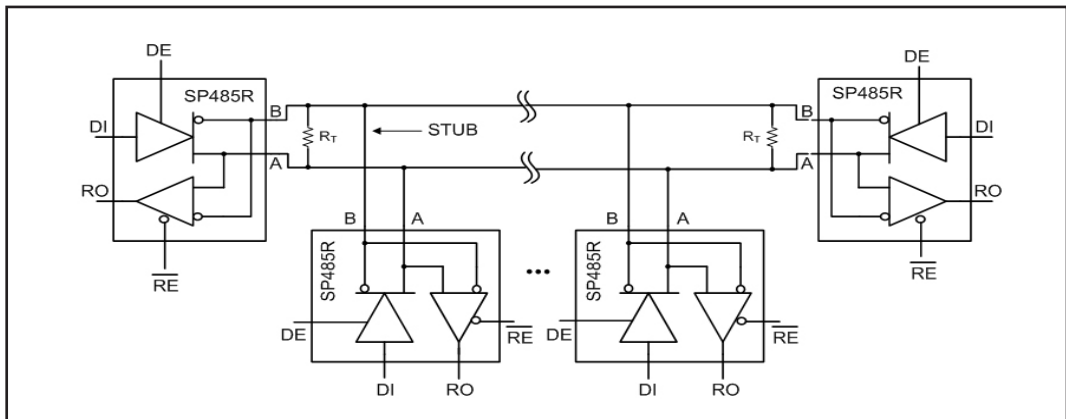

Figure 1. Typical Application Circuit

ABSOLUTE MAXIMUM RATINGS

These are stress ratings only and functional operation of the device at these ratings or any other above those indicated in the operation sections of the specifications below is not implied. Exposure to absolute maximum rating conditions for extended periods of time may affect reliability.

V_{CC}+7V
Storage Temperature.....-65°C to +150°C

Power Dissipation

8-pin NSOIC.....1000mW

($\theta_{JA} = 62^{\circ}\text{C/W}$)

8-pin PDIP.....1000mW

($\theta_{JA} = 62^{\circ}\text{C/W}$)

ELECTRICAL CHARACTERISTICS

Typically 25°C @ $V_{CC} = +5V$ unless otherwise noted.

| PARAMETERS | MIN. | TYP. | MAX. | UNITS | CONDITIONS |
|---|------|------|--------|---------------|---|
| LOGIC INPUTS | | | | | |
| V_{IL} | | | 0.8 | Volts | |
| V_{IH} | 2.0 | | | Volts | |
| LOGIC OUTPUTS | | | | | |
| V_{OL} | | | 0.4 | Volts | $I_{OUT} = -3.2\text{mA}$ |
| V_{OH} | 2.4 | | | Volts | $I_{OUT} = 1.0\text{mA}$ |
| RS-485 DRIVER DC Characteristics | | | | | |
| Open Circuit Voltage | | | 6.0 | Volts | |
| Differential Output Voltage | 1.5 | | 5.0 | Volts | $R_L = 54\Omega, C_L = 50\text{pF}$ |
| Balance | | | +/-0.2 | Volts | $ V_T - \overline{V_T} $ |
| Common-Mode Output | | | 3.0 | Volts | |
| Output Current | 28.0 | | | mA | $R_L = 54\Omega$ |
| Short Circuit Current | | | +/-250 | mA | Terminated in -7V to +12V |
| RS-485 DRIVER AC Characteristics | | | | | |
| Maximum Data Rate | 5 | | | Mbps | $R_L = 54\Omega,$ |
| Output Transition Time | | 30 | | ns | Rise/fall time, 10% to 90% |
| Propagation Delay, t_{PLH} | | 60 | 100 | ns | See Figures 4 & 6, $R_{DIFF} = 54\Omega,$ $C_{L1} = C_{L2} = 100\text{pF}$ |
| Propagation Delay, t_{PHL} | | 60 | 100 | ns | See Figures 4 & 6, $R_{DIFF} = 54\Omega,$ $C_{L1} = C_{L2} = 100\text{pF}$ |
| Driver Output Skew | | 5 | 15 | ns | see Figures 4 and 6, $t_{SKEW} = t_{DPHL} - t_{DPLH} $ |
| RS-485 RECEIVER DC Characteristics | | | | | |
| Output Voltage Low, V_{OL} | | | 0.4 | Volts | |
| Output Voltage High, V_{OH} | 2.4 | | | Volts | |
| Tri-State Output Current | | | +/-1 | μA | $0.4V \leq V_{OUT} \leq 2.4V; \overline{RE} = V_{CC}$ |

ELECTRICAL CHARACTERISTICS

Typically 25°C @ $V_{CC} = +5V$ unless otherwise noted.

| PARAMETERS | MIN. | TYP. | MAX. | UNITS | CONDITIONS |
|---|-------|------|--------|-------------|---|
| RS-485 RECEIVER DC Characteristics (continued) | | | | | |
| Common Mode Range | -7.0 | | +12.0 | Volts | |
| Receiver Sensitivity | | | +/-0.2 | Volts | $-7V \leq V_{CM} \leq +12V$ |
| Input Impedance | 120 | 150 | | k Ω | $-7V \leq V_{CM} \leq +12V$ |
| RS-485 RECEIVER AC Characteristics | | | | | |
| Maximum Data Rate | 1 | | | Mbps | |
| Propagation Delay; t_{PHL} | | | 1200 | ns | See Figures 4 & 8, $R_{DIFF} = 54\Omega$, $C_{L1} = C_{L2} = 100pF$ |
| Propagation Delay; t_{PLH} | | | 1200 | ns | See Figures 4 & 8, $R_{DIFF} = 54\Omega$, $C_{L1} = C_{L2} = 100pF$ |
| Differential Receiver Skew | | 60 | | ns | See Figures 4 & 8, $R_{DIFF} = 54\Omega$, $C_{L1} = C_{L2} = 100pF$, $t_{SKEW} = t_{PHL} - t_{PLH} $ |
| RS-485 DRIVER Enable / Disable Time | | | | | |
| Driver Enable to Output Low | | 40 | 500 | ns | $C_L = 15pF$, see Figures 5 and 7, S_1 closed |
| Driver Enable to Output High | | 40 | 500 | ns | $C_L = 15pF$, see Figures 5 and 7, S_2 closed |
| Driver Disable Time from Low | | 40 | 500 | ns | $C_L = 15pF$, see Figures 5 and 7, S_1 closed |
| Driver Disable Time from High | | 40 | 500 | ns | $C_L = 15pF$, see Figures 5 and 7, S_2 closed |
| RS-485 RECEIVER Enable / Disable Time | | | | | |
| Receiver Enable to Output Low | | 40 | 500 | ns | $C_L = 15pF$, see Figures 3 and 9, S_1 closed |
| Receiver Enable to Output High | | 40 | 500 | ns | $C_L = 15pF$, see Figures 3 and 9, S_2 closed |
| Receiver Disable from Low | | 40 | 500 | ns | $C_L = 15pF$, see Figures 3 and 9, S_1 closed |
| Receiver Disable from High | | 40 | 500 | ns | $C_L = 15pF$, see Figures 3 and 9, S_1 closed |
| POWER REQUIREMENTS | | | | | |
| Supply Voltage V_{CC} | +4.75 | | +5.25 | Volts | |
| Supply Current I_{CC} , No Load | | 300 | 500 | μA | $\overline{RE} = V_{CC}$ or 0V, DE = 0V |
| Supply Current I_{CC} , No Load | | 500 | 900 | μA | $\overline{RE} = V_{CC}$ or 0V, DE = VCC |
| ENVIRONMENTAL | | | | | |
| Operating Temperature | | | | | |
| Commercial (...C..) | 0 | | +70 | $^{\circ}C$ | |
| Industrial (...E..) | -40 | | +85 | $^{\circ}C$ | |
| Storage Temperature | -65 | | +150 | $^{\circ}C$ | |

PIN FUNCTION

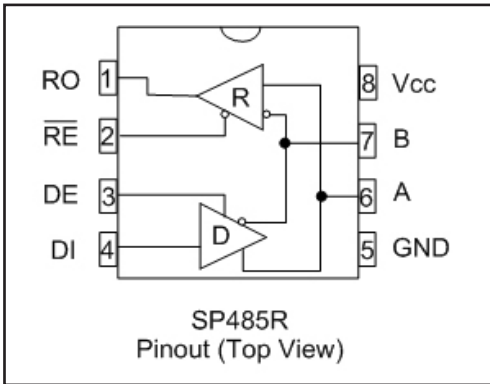

- Pin 1 - RO - Receiver Output
- Pin 2 - \overline{RE} - Receiver Output Enable Active LOW
- Pin 3 - DE - Driver Output Enable Active HIGH
- Pin 4 DI - Driver Input
- Pin 5 - GND - Ground Connection
- Pin 6 - A - Driver Output / Receiver input Non-Inverting
- Pin 7 - B - Driver Output / Receiver Input Inverting
- Pin 8 - Vcc - Positive Supply $4.75V \leq V_{CC} \leq 5.25V$

RECEIVER INPUT GRAPH

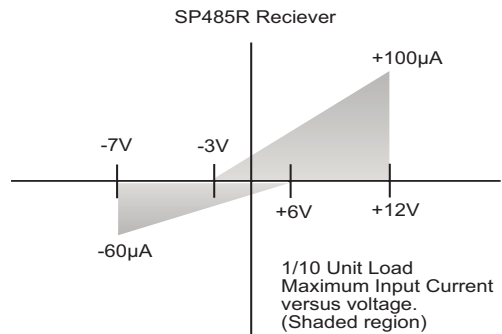
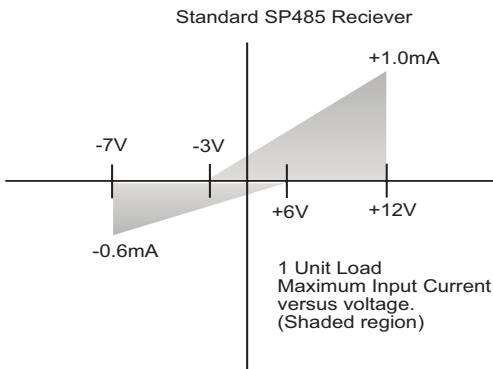

TEST CIRCUITS

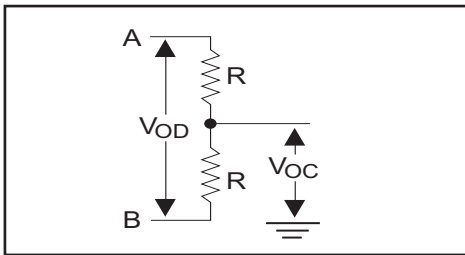

Figure 2. Driver DC Test Load Circuit

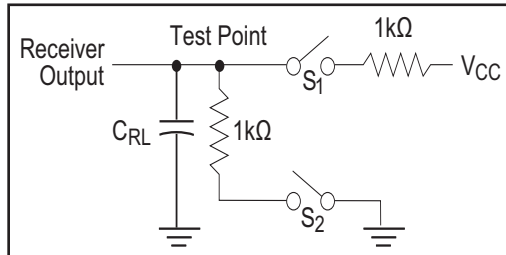

Figure 3. Receiver Timing Test Load Circuit

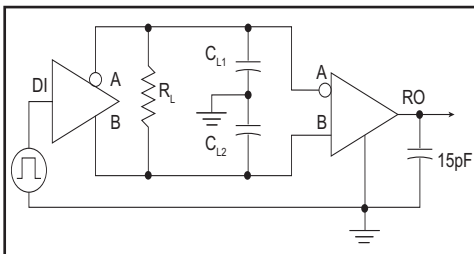

Figure 4. RS-485 Driver/Receiver Timing Test

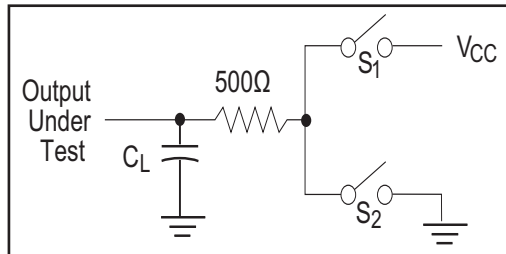

Figure 5. Driver Timing Test Load #2 Circuit

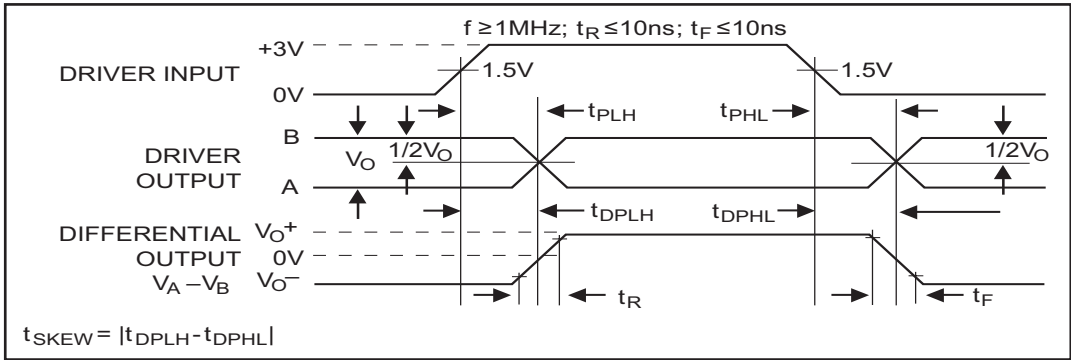

Figure 6. Driver Propagation Delays

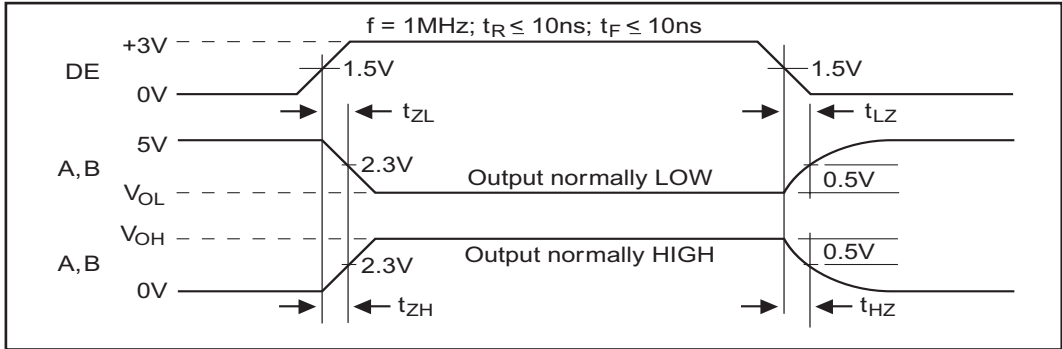

Figure 7. Driver Enable and Disable Times

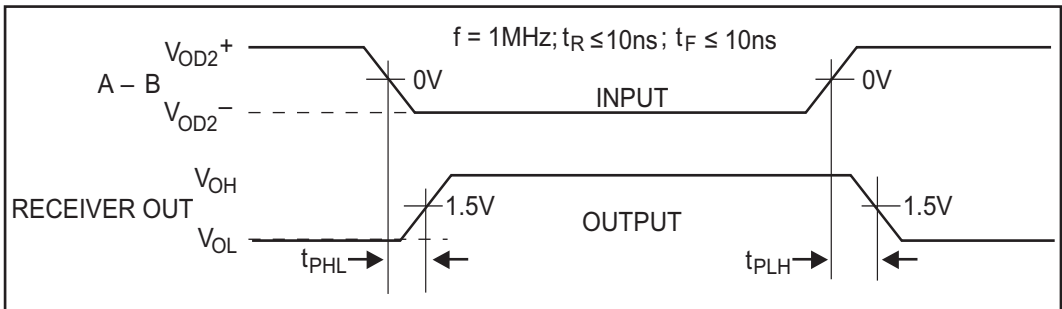

Figure 8. Receiver Propagation Delays

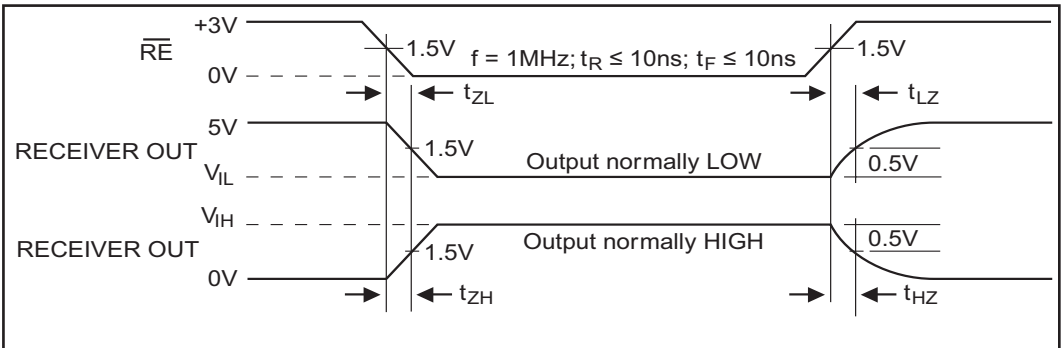

Figure 9. Receiver Enable and Disable Times

The **SP485R** is a low power RS-485 differential transceiver. Similar to the SP485, the **SP485R** contains a half-duplex driver and receiver with tri-state control. However, the **SP485R** is intended for increased connections on a single bus compared to the original RS-485 specification.

The RS-485 standard is ideal for multi-drop applications where one bus can contain many drivers and/or receivers. The RS-485 standard implementation allows up to 32 transceivers to be connected on to the data bus. RS-485 is also specified for driving higher speeds over long cable lengths of up to 4000 feet. The **SP485R** exceeds the standard by allowing up to 400 receivers to share the bus

DRIVERS

The driver output complies with the RS-485 electrical characteristics as specified by the standard. The output swings from 0V to V_{cc} and maintains greater than +1.5V with a 54Ω load attached between the two outputs. In adhering to the RS-485 specification, the driver outputs inherently comply with the RS-422 standard. With a load of 100Ω between the two outputs, the driver can sustain at least +2.0V.

The driver contains an enable pin (DE) which tri-states the output when DE is logic LOW. The outputs during the tri-state condition are at high impedance (>100kΩ). A logic HIGH enables the driver for normal operation. The driver can operate to at least 5Mbps.

RECEIVERS

The **SP485R** receiver has differential inputs with an input sensitivity of lower than ±200mV. As mentioned above, the RS-485 specification allows up to 32 transceivers on the same bus. The **SP485R** allows over 400 transceivers on the same bus due to its high impedance of at least 120kΩ. This higher capacity allows more components to be attached to the same bus without degrading the signal quality. The drivers are still able to drive an equivalent 54Ω from the 320

transceivers with an input impedance of at least 120kΩ in parallel along with the two 125Ω cable termination resistors on each end.

The receiver contains an enable pin (\overline{RE}) which enables the receiver when a logic LOW is asserted. A logic HIGH will tri-state the receiver output and the inputs will maintain at least 120kΩ impedance. The receiver can operate to at least 1Mbps

The receiver also contains a fail-safe feature which outputs a logic HIGH when the inputs are open as in a disconnected cable.

| REVISION HISTORY | | | |
|------------------|--------------------------------------|----------|-------|
| REV | DESCRIPTION | DATE | APP'D |
| A | DRAWING ORIGINATOR | 08/16/05 | JL |
| B | DRAWING FORMAT MODIFICATION | 07/19/06 | JL |
| C | CHANGE DRAWING LOGO AND COMPANY NAME | 11/16/07 | JL |

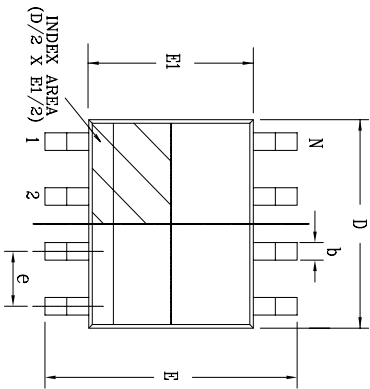

Top View

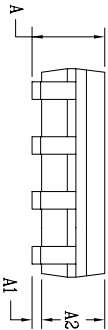

Side View

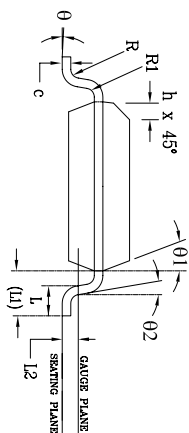

Front View

| 8 Pin SOICN JEDEC MS-012 Variation AA | | | | | | | | | | |
|---------------------------------------|------------------------------------|------|------|-------|--|-----|-------|-------|-----|-----|
| SYMBOLS | DIMENSIONS IN MM (Control Unit) | | | | DIMENSIONS IN INCH (Reference Unit) | | | | MIN | MAX |
| | MIN | NOM | MAX | | MIN | NOM | MAX | | | |
| A | 1.35 | — | 1.75 | 0.053 | — | — | — | 0.069 | — | — |
| A1 | 0.10 | — | 0.25 | 0.004 | — | — | 0.010 | — | — | — |
| A2 | 1.25 | — | 1.65 | 0.049 | — | — | 0.065 | — | — | — |
| b | 0.31 | — | 0.51 | 0.012 | — | — | 0.020 | — | — | — |
| c | 0.17 | — | 0.25 | 0.007 | — | — | 0.010 | — | — | — |
| E | 6.00 | BSC | — | — | — | — | 0.236 | BSC | — | — |
| E1 | 3.90 | BSC | — | — | — | — | 0.154 | BSC | — | — |
| e | 1.27 | BSC | — | — | — | — | 0.050 | BSC | — | — |
| h | 0.25 | — | 0.50 | 0.010 | — | — | 0.020 | — | — | — |
| L | 0.40 | — | 1.27 | 0.016 | — | — | 0.050 | — | — | — |
| L1 | — | 1.04 | REF | — | — | — | 0.041 | REF | — | — |
| L2 | — | 0.25 | BSC | — | — | — | 0.010 | BSC | — | — |
| R | 0.07 | — | — | 0.003 | — | — | — | — | — | — |
| R1 | 0.07 | — | — | 0.003 | — | — | — | — | — | — |
| θ | 0° | — | 8° | 0° | — | — | 8° | — | — | — |
| θ1 | 5° | — | 15° | 5° | — | — | 15° | — | — | — |
| θ2 | 0° | — | — | 0° | — | — | — | — | — | — |
| D | 4.90 | BSC | — | — | — | — | 0.193 | BSC | — | — |
| N | 8 | — | — | — | — | — | 8 | — | — | — |

| | | | |
|---|--|--|--|
|  | | EXAR CORPORATION Fremont, CA 94538 | |
| | | | |
| Drawing No.: 8 PIN SOICN PACKAGE OUTLINE | | Revision: C | |
| 8 PIN SOICN PACKAGE OUTLINE | | Sheet: 1 OF 1 | |

| REVISION HISTORY | | | | |
|------------------|--------------------------------------|----------|-------|--|
| REV. | DESCRIPTION | DATE | APP'D | |
| A | DRAWING ORIGINATION | 04/26/06 | JL | |
| B | CHANGE DRAWING LOGO AND COMPANY NAME | 11/28/07 | JL | |

REMARKS:
 FOR 8LD AND 16LD
 ALL END LEADS (4X)
 ARE HALF LEAD TYPES

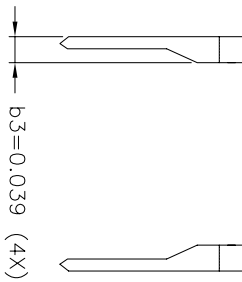
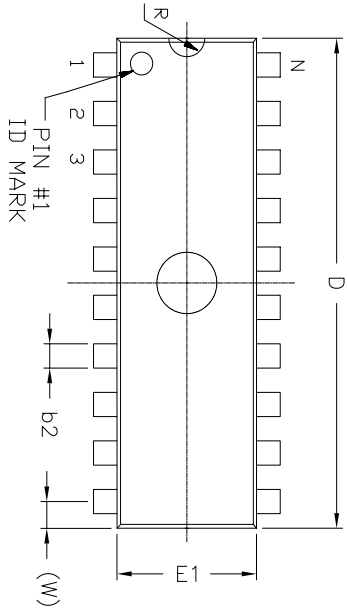

Top View

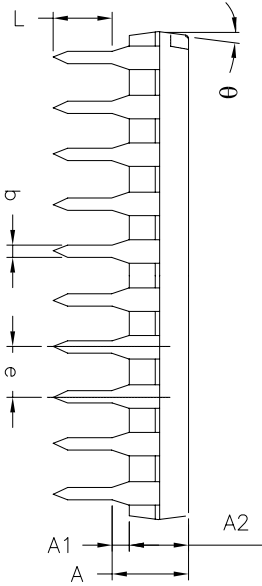

Side View

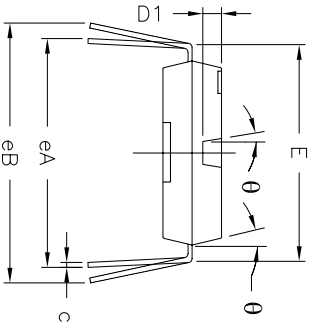

Front View

| 8 Pin PDIP JEDEC MS-001 Variation BA | | | | | | | | | | |
|--------------------------------------|--------------------------------------|-------|----------|------|-------|--------------------------------------|--|--|--|--|
| SYMBOLS | DIMENSIONS IN INCH (Control Unit) | | | | | DIMENSIONS IN MM (Reference Unit) | | | | |
| | MIN | NOM | MAX | MIN | NOM | MAX | | | | |
| A | — | — | 0.210 | — | — | 5.33 | | | | |
| A1 | 0.015 | — | — | 0.38 | — | — | | | | |
| A2 | 0.115 | 0.130 | 0.195 | 2.92 | 3.30 | 4.95 | | | | |
| b | 0.014 | 0.018 | 0.022 | 0.36 | 0.46 | 0.56 | | | | |
| b2 | 0.045 | 0.060 | 0.070 | 1.14 | 1.52 | 1.78 | | | | |
| c | 0.008 | 0.010 | 0.014 | 0.20 | 0.25 | 0.36 | | | | |
| D1 | 0.030 | — | 0.060 | 0.76 | — | 1.52 | | | | |
| E | 0.300 | 0.310 | 0.325 | 7.62 | 7.87 | 8.26 | | | | |
| E1 | 0.240 | 0.250 | 0.280 | 6.10 | 6.35 | 7.11 | | | | |
| e | 0.100 BSC | | 2.54 BSC | | | | | | | |
| eA | 0.300 BSC | | 7.62 BSC | | | | | | | |
| eB | — | 0.430 | — | — | 10.92 | | | | | |
| L | 0.115 | 0.130 | 0.150 | 2.92 | 3.30 | 3.81 | | | | |
| W | 0.075 REF | | 1.91 REF | | | | | | | |
| R | 0.030 BSC | | 0.76 BSC | | | | | | | |
| theta | 4° | 7° | 10° | 4° | 7° | 10° | | | | |
| D | 0.355 | 0.365 | 0.400 | 9.02 | 9.27 | 10.16 | | | | |
| N | 8 | | 8 | | | | | | | |

| | | | |
|---------------------|----------------|----------------------------|--------|
| | | EXAR CORPORATION | |
| | | 8 PIN PDIP PACKAGE OUTLINE | |
| Packaging Approval: | Drawing No.: | Revision: | Sheet: |
| By: JL | Date: 11/28/07 | B | 1 OF 1 |

ORDERING INFORMATION

| Model | Temperature Range | Package Types |
|--------------------|---------------------|---------------|
| SP485RCN-L..... | 0°C to +70°C..... | 8-pin NSOIC |
| SP485RCN-L/TR..... | 0°C to +70°C..... | 8-pin NSOIC |
| SP485RCP-L..... | 0°C to +70°C..... | 8-pin PDIP |
| SP485REN-L..... | -40°C to +85°C..... | 8-pin NSOIC |
| SP485REN-L/TR..... | -40°C to +85°C..... | 8-pin NSOIC |
| SP485REP-L..... | -40°C to +85°C..... | 8-pin PDIP |

Note: /TR = Tape and Reel

REVISION HISTORY

| DATE | REVISION | DESCRIPTION |
|----------|----------|---|
| 06/21/04 | -- | Legacy Sipex Datasheet |
| 07/23/09 | 1.0.0 | Convert to Exar Format. Update ordering information as a result of discontinued Lead type package options per PDN 081126-01. Remove all reference to the discontinued SP481R. |

Notice

EXAR Corporation reserves the right to make changes to any products contained in this publication in order to improve design, performance or reliability. EXAR Corporation assumes no representation that the circuits are free of patent infringement. Charts and schedules contained herein are only for illustration purposes and may vary depending upon a user's specific application. While the information in this publication has been carefully checked; no responsibility, however, is assumed for inaccuracies.

EXAR Corporation does not recommend the use of any of its products in life support applications where the failure or malfunction of the product can reasonably be expected to cause failure of the life support system or to significantly affect its safety or effectiveness. Products are not authorized for use in such applications unless EXAR Corporation receives, in writing, assurances to its satisfaction that: (a) the risk of injury or damage has been minimized ; (b) the user assumes all such risks; (c) potential liability of EXAR Corporation is adequately protected under the circumstances.

Copyright 2009 EXAR Corporation



Datasheet July 2009

Send your Interface technical inquiry with technical details to: uarttechsupport@exar.com







Reproduction, in part or whole, without the prior written consent of EXAR Corporation is prohibited.

Looking for pricing, stock, or lifecycle information?

Click below to explore more details on WIN SOURCE:

-  [View SP485RCP-L on WIN SOURCE](#)
-  [Exar Corporation](#) Information

Optimize Your Supply Chain with WIN SOURCE Solutions

-  Global Sourcing Solution
-  Obsolete Management
-  Cost Control Management
-  Shortage Management
-  Alternative Solution
-  Excess Inventory Management