



Silicon PIN Photodiode



DESCRIPTION

TEFD4300F is a silicon PIN photodiode with high radiant sensitivity in black, T-1 plastic package with daylight blocking filter. Filter bandwidth is matched with 850 nm to 950 nm IR emitters.

FEATURES

- Package type: leaded
- Package form: T-1
- Dimensions (in mm): Ø 3
- High radiant sensitivity
- Daylight blocking filter matched with 850 nm to 950 nm emitters
- Fast response times
- Angle of half sensitivity: $\phi = \pm 20^\circ$
- Package matched with IR emitter series VSLB3940, TSUS4300, and TSAL4400
- Material categorization: for definitions of compliance please see www.vishay.com/doc?99912



APPLICATIONS

- High speed photo detector for data transmission
- Optical switches
- Counters and sorters
- Interrupters
- Encoders
- Position sensors

| PRODUCT SUMMARY | | | |
|-----------------|----------------------|---------|-----------------------|
| COMPONENT | I _{ra} (µA) | φ (deg) | λ _{0.5} (nm) |
| TEFD4300F | 17 | ± 20 | 770 to 1070 |

Note

- Test condition see table “Basic Characteristics”

| ORDERING INFORMATION | | | |
|----------------------|---------------|--------------------------------|--------------|
| ORDERING CODE | PACKAGING | REMARKS | PACKAGE FORM |
| TEFD4300F | Bulk | MOQ: 5000 pcs, 5000 pcs/bulk | T-1 |
| TEFD4300F-QS21 | Tape and reel | MOQ: 10 000 pcs, 2000 pcs/reel | T-1 |

Note

- MOQ: minimum order quantity

| ABSOLUTE MAXIMUM RATINGS (T _{amb} = 25 °C, unless otherwise specified) | | | | |
|---|--|-------------------|-------------|------|
| PARAMETER | TEST CONDITION | SYMBOL | VALUE | UNIT |
| Reverse voltage | | V _R | 60 | V |
| Power dissipation | T _{amb} ≤ 25 °C | P _V | 215 | mW |
| Junction temperature | | T _j | 100 | °C |
| Operating temperature range | | T _{amb} | -40 to +100 | °C |
| Storage temperature range | | T _{stg} | -40 to +100 | °C |
| Soldering temperature | t ≤ 3 s, 2 mm from case | T _{sd} | 260 | °C |
| Thermal resistance junction / ambient | Connected with Cu wire, 0.14 mm ² | R _{thJA} | 450 | K/W |

| BASIC CHARACTERISTICS ($T_{amb} = 25\text{ }^{\circ}\text{C}$, unless otherwise specified) | | | | | | |
|---|--|-----------------|------|----------|------|---------------|
| PARAMETER | TEST CONDITION | SYMBOL | MIN. | TYP. | MAX. | UNIT |
| Forward voltage | $I_F = 50\text{ mA}$ | V_F | - | 1 | - | V |
| Breakdown voltage | $I_R = 100\text{ }\mu\text{A}$, $E = 0$ | $V_{(BR)}$ | 60 | - | - | V |
| Reverse dark current | $V_R = 10\text{ V}$, $E = 0$ | I_{r0} | - | 0.15 | 3 | nA |
| Diode capacitance | $V_R = 0\text{ V}$, $f = 1\text{ MHz}$, $E = 0$ | C_D | - | 3.3 | - | pF |
| | $V_R = 5\text{ V}$, $f = 1\text{ MHz}$, $E = 0$ | C_D | - | 1.2 | - | pF |
| Open circuit voltage | $E_e = 1\text{ mW/cm}^2$, $\lambda = 950\text{ nm}$ | V_{OC} | - | 350 | - | mV |
| Temperature coefficient of V_{OC} | $E_e = 1\text{ mW/cm}^2$, $\lambda = 950\text{ nm}$ | $TK_{V_{OC}}$ | - | -2.6 | - | mV/K |
| Short circuit current | $E_e = 1\text{ mW/cm}^2$, $\lambda = 950\text{ nm}$ | I_k | - | 15 | - | μA |
| Temperature coefficient of I_k | $E_e = 1\text{ mW/cm}^2$, $\lambda = 950\text{ nm}$ | TK_{I_k} | - | 0.1 | - | %/K |
| Reverse light current | $E_e = 1\text{ mW/cm}^2$, $\lambda = 950\text{ nm}$, $V_R = 5\text{ V}$ | I_{ra} | 9 | 17 | 27 | μA |
| Angle of half sensitivity | | ϕ | - | ± 20 | - | deg |
| Wavelength of peak sensitivity | | λ_p | - | 950 | - | nm |
| Range of spectral bandwidth | | $\lambda_{0.5}$ | 770 | - | 1070 | nm |
| Rise time | $V_R = 10\text{ V}$, $R_L = 1\text{ k}\Omega$, $\lambda = 820\text{ nm}$ | t_r | - | 100 | - | ns |
| Fall time | $V_R = 10\text{ V}$, $R_L = 1\text{ k}\Omega$, $\lambda = 820\text{ nm}$ | t_f | - | 100 | - | ns |

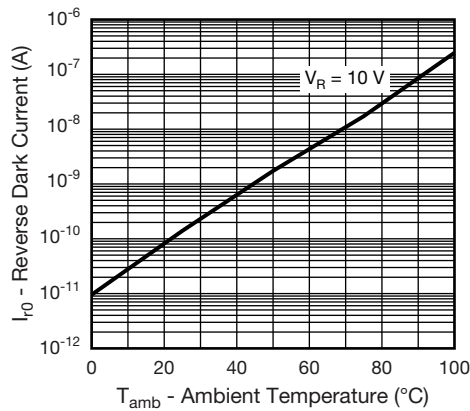
BASIC CHARACTERISTICS ($T_{amb} = 25\text{ }^{\circ}\text{C}$, unless otherwise specified)


Fig. 1 - Reverse Dark Current vs. Ambient Temperature

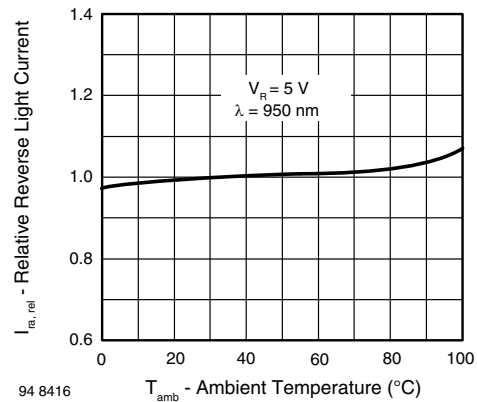


Fig. 2 - Relative Reverse Light Current vs. Ambient Temperature

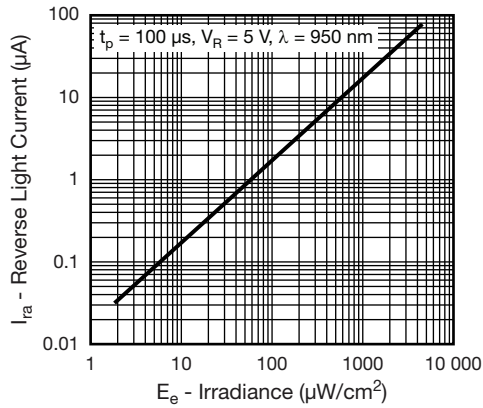


Fig. 3 - Reverse Light Current vs. Irradiance

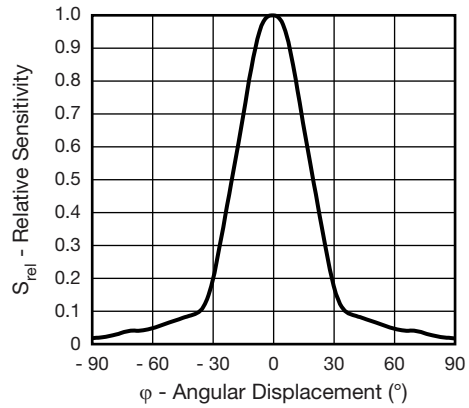


Fig. 6 - Relative Radiant Intensity vs. Angular Displacement

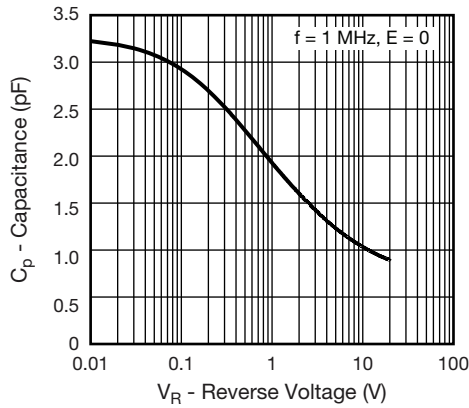


Fig. 4 - Diode Capacitance vs. Reverse Voltage

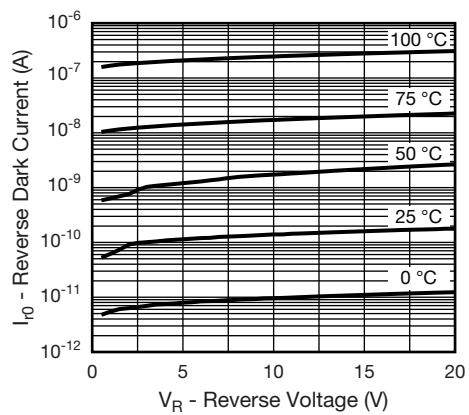


Fig. 7 - Dark Current vs. Reverse Voltage

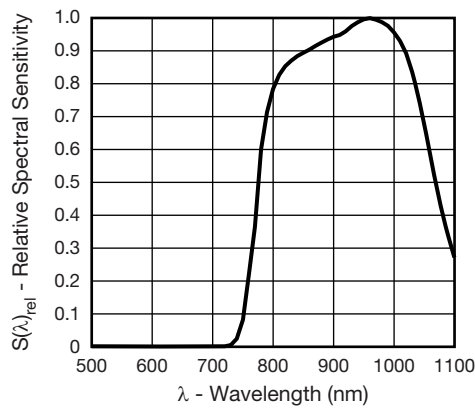
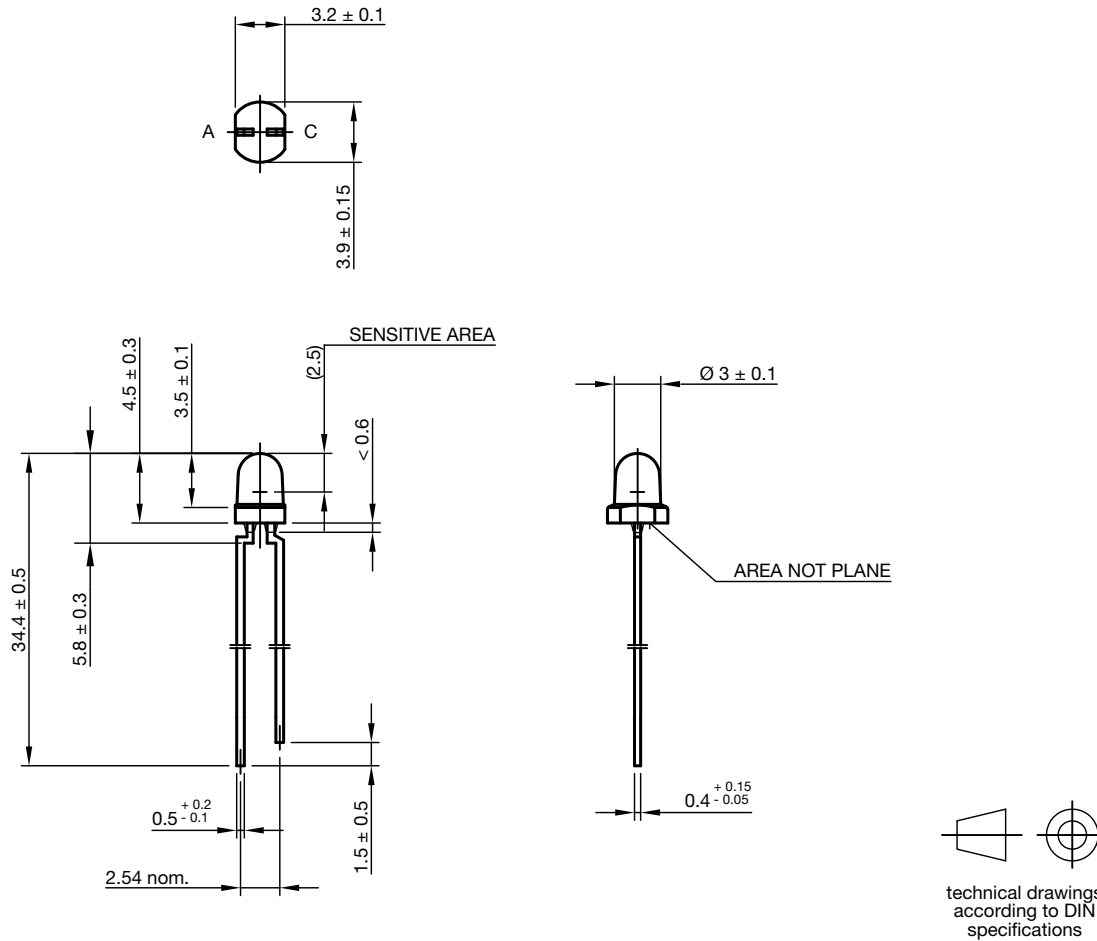


Fig. 5 - Relative Spectral Sensitivity vs. Wavelength



PACKAGE DIMENSIONS in millimeters



Drawing-No.: 6.544-5411.01-4
Issue: 2; 28.07.14



Disclaimer

ALL PRODUCT, PRODUCT SPECIFICATIONS AND DATA ARE SUBJECT TO CHANGE WITHOUT NOTICE TO IMPROVE RELIABILITY, FUNCTION OR DESIGN OR OTHERWISE.

Vishay Intertechnology, Inc., its affiliates, agents, and employees, and all persons acting on its or their behalf (collectively, "Vishay"), disclaim any and all liability for any errors, inaccuracies or incompleteness contained in any datasheet or in any other disclosure relating to any product.

Vishay makes no warranty, representation or guarantee regarding the suitability of the products for any particular purpose or the continuing production of any product. To the maximum extent permitted by applicable law, Vishay disclaims (i) any and all liability arising out of the application or use of any product, (ii) any and all liability, including without limitation special, consequential or incidental damages, and (iii) any and all implied warranties, including warranties of fitness for particular purpose, non-infringement and merchantability.

Statements regarding the suitability of products for certain types of applications are based on Vishay's knowledge of typical requirements that are often placed on Vishay products in generic applications. Such statements are not binding statements about the suitability of products for a particular application. It is the customer's responsibility to validate that a particular product with the properties described in the product specification is suitable for use in a particular application. Parameters provided in datasheets and / or specifications may vary in different applications and performance may vary over time. All operating parameters, including typical parameters, must be validated for each customer application by the customer's technical experts. Product specifications do not expand or otherwise modify Vishay's terms and conditions of purchase, including but not limited to the warranty expressed therein.

Except as expressly indicated in writing, Vishay products are not designed for use in medical, life-saving, or life-sustaining applications or for any other application in which the failure of the Vishay product could result in personal injury or death. Customers using or selling Vishay products not expressly indicated for use in such applications do so at their own risk. Please contact authorized Vishay personnel to obtain written terms and conditions regarding products designed for such applications.

No license, express or implied, by estoppel or otherwise, to any intellectual property rights is granted by this document or by any conduct of Vishay. Product names and markings noted herein may be trademarks of their respective owners.

Looking for pricing, stock, or lifecycle information?

Click below to explore more details on WIN SOURCE:

 [View TEFD4300F on WIN SOURCE](#)

 [Vishay Information](#)

Optimize Your Supply Chain with WIN SOURCE Solutions

-  Global Sourcing Solution
-  Obsolete Management
-  Cost Control Management
-  Shortage Management
-  Alternative Solution
-  Excess Inventory Management