



THE DATASHEET OF EL3H7(B)(TA)-VG



Features:

- Halogens free
- Current transfer ratio
(CTR: 50~600% at $I_F = 5\text{mA}$, $V_{CE} = 5\text{V}$)
(CTR: 40~320% at $I_F = 10\text{mA}$, $V_{CE} = 5\text{V}$)
- High isolation voltage between input and output ($V_{iso} = 3750\text{ V rms}$)
- Compact 4 Pin SSOP with a 2.0 mm profile
- Pb free and RoHS compliant.
- UL approved (No. 214129)
- VDE approval (132249)
- SEMKO approved
- NEMKO approved
- DEMKO approved
- FIMKO approved
- CSA approved

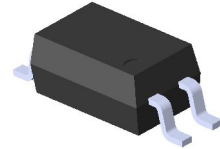

Schematic

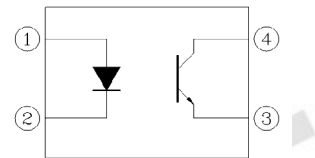

Pin Configuration

1. Anode
2. Cathode
3. Emitter
4. Collector

Description

The EL3H7-G series devices consist of an infrared emitting diode, optically coupled to a phototransistor detector encapsulated with green compound.

They are packaged in a 4-pin small outline SMD package.

Applications

- DC-DC Converters
- Programmable controllers
- Telecommunication equipments
- Signal transmission between circuits of different potentials and impedances

Absolute Maximum Ratings ($T_a=25^{\circ}\text{C}$)

Parameter		Symbol	Rating	Unit
Input	Forward current	I_F	50	mA
	Peak forward current (1us, pulse)	I_{FP}	1	A
	Reverse voltage	V_R	6	V
	Power dissipation Derating factor (above $T_a = 90^{\circ}\text{C}$)	P_D	70	mW
2.0			mW/ $^{\circ}\text{C}$	
Output	Power dissipation Derating factor (above $T_a = 70^{\circ}\text{C}$)	P_C	150	mW
			3.1	mW/ $^{\circ}\text{C}$
	Collector current	I_C	50	mA
	Collector-Emitter voltage	V_{CEO}	80	V
	Emitter-Collector voltage	V_{ECO}	7	V
Total power dissipation		P_{TOT}	200	mW
Isolation voltage ^{*1}		V_{ISO}	3750	V rms
Operating temperature		T_{OPR}	-55 ~ +110	$^{\circ}\text{C}$
Storage temperature		T_{STG}	-55 ~ +125	$^{\circ}\text{C}$
Soldering temperature ^{*2}		T_{SOL}	260	$^{\circ}\text{C}$

Notes

*1 AC for 1 minute, R.H.= 40 ~ 60% R.H. In this test, pins 1 & 2 are shorted together, and pins 3 & 4 are shorted together.

*2 For 10 seconds.

Electrical Characteristics ($T_a=25^{\circ}\text{C}$ unless specified otherwise)

Input

Parameter	Symbol	Min.	Typ.*	Max.	Unit	Condition
Forward voltage	V_F	-	1.2	1.4	V	$I_F = 20\text{mA}$
Reverse current	I_R	-	-	10	μA	$V_R = 4\text{V}$
Input capacitance	C_{in}	-	30	250	pF	$V = 0, f = 1\text{kHz}$

Output

Parameter	Symbol	Min.	Typ.*	Max.	Unit	Condition
Collector-Emitter dark current	I_{CEO}	-	-	100	nA	$V_{CE} = 20\text{V}, I_F = 0\text{mA}$
Collector-Emitter breakdown voltage	BV_{CEO}	80	-	-	V	$I_C = 0.1\text{mA}$
Emitter-Collector breakdown voltage	BV_{ECO}	7	-	-	V	$I_E = 0.1\text{mA}$

Transfer Characteristics ($T_a=25^{\circ}\text{C}$ unless specified otherwise)

Parameter	Symbol	Min.	Typ.*	Max.	Unit	Condition
Current Transfer ratio	EL3H7	50	-	600	%	$I_F = 5\text{mA}, V_{CE} = 5\text{V}$
	EL3H7A	80	-	160		
	EL3H7B	130	-	260		
	EL3H7C	200	-	400		
	EL3H7D	300	-	600		
	EL3H7E	100	-	200		
	EL3H7F	150	-	300		$I_F = 10\text{mA}, V_{CE} = 5\text{V}$
	EL3H7H	40	-	80		
	EL3H7I	63	-	125		
	EL3H7J	100	-	200		
	EL3H7K	160	-	320		
		CTR				

Transfer Characteristics ($T_a=25^\circ\text{C}$ unless specified otherwise)

Parameter	Symbol	Min.	Typ.*	Max.	Unit	Condition
Collector-Emitter saturation voltage	$V_{CE(sat)}$	-	0.1	0.2	V	$I_F = 10\text{mA}$, $I_C = 1\text{mA}$
Isolation resistance	R_{IO}	5×10^{10}	-	-	Ω	$V_{IO} = 500\text{Vdc}$, 40~60% R.H.
Floating capacitance	C_{IO}	-	0.3	1.0	pF	$V_{IO} = 0$, $f = 1\text{MHz}$
Rise time	t_r	-	5	18	μs	$V_{CE} = 2\text{V}$, $I_C = 2\text{mA}$, $R_L = 100\Omega$
Fall time	t_f	-	3	18	μs	

* Typical values at $T_a = 25^\circ\text{C}$

EVERLIGHT

Typical Performance Curves

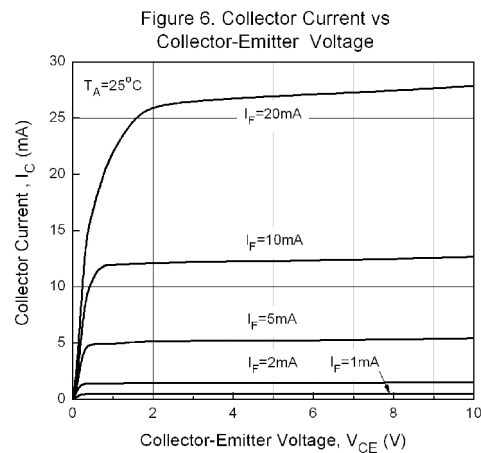
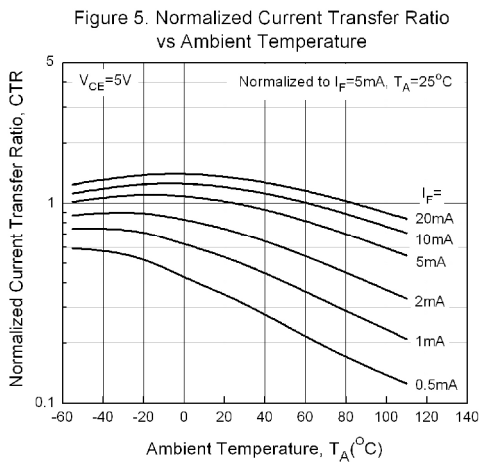
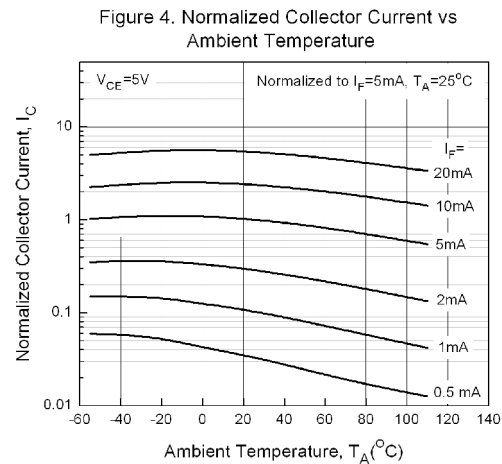
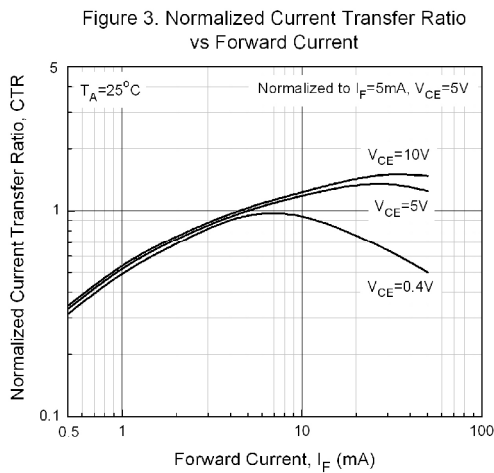
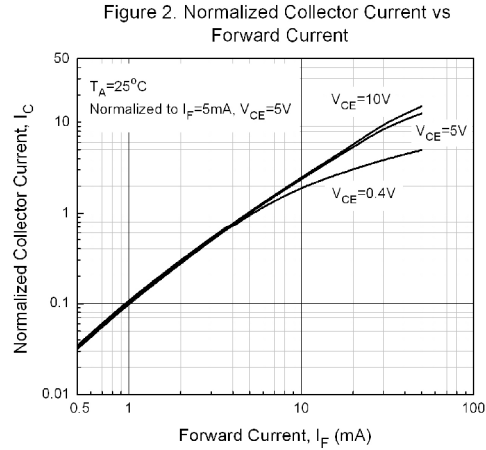
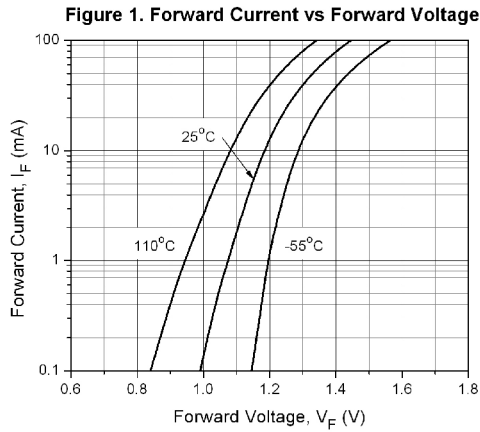

Figure 7. Collector Current vs Collector-Emitter Voltage

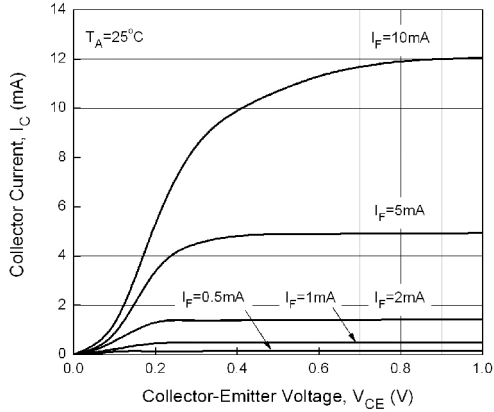

Figure 8. Collector Dark Current vs Ambient Temperature

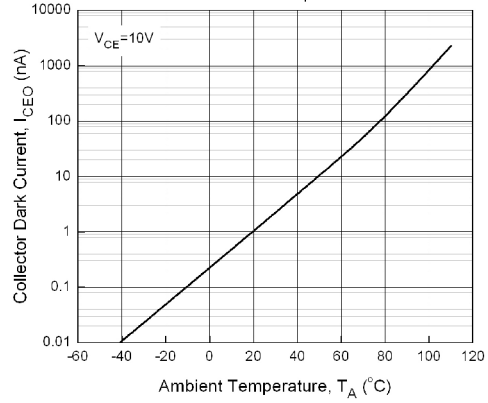

Figure 9. Collector-Emitter Saturation Voltage vs Ambient Temperature

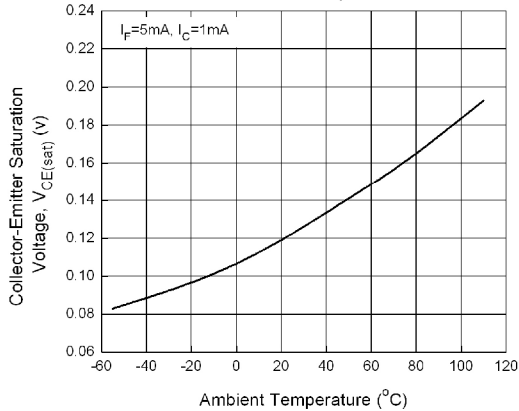

Figure 10. Switching Time vs Load Resistance

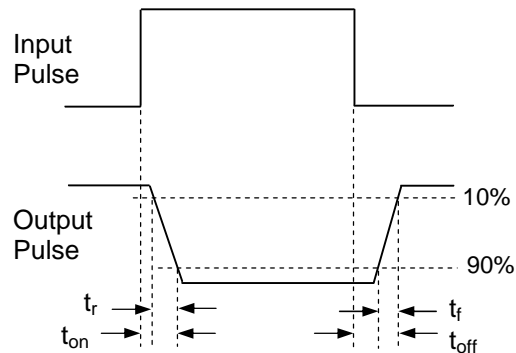
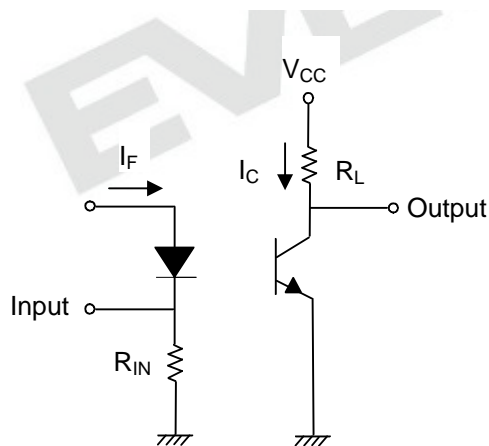
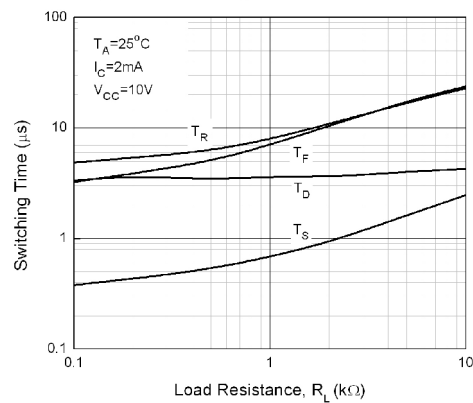

Figure 11. Switching Time Test Circuit & Waveforms

Order Information

Part Number

EL3H7(X)(Y)-VG

Note

3H7 = Part No.

X = CTR Rank (A, B, C, D, E, F, H, I, J, K or none)

Y = Tape and reel option (TA, TB, EA, EB or none).

V = VDE (optional)

G = Halogens free

Option	Description	Packing quantity
None	Standard SMD option	100 units per tube
-V	Standard SMD option + VDE	100 units per tube
(TA)	TA Tape & reel option	5000 units per reel
(TB)	TB Tape & reel option	5000 units per reel
(TA)-V	TA Tape & reel option + VDE	5000 units per reel
(TB)-V	TB Tape & reel option + VDE	5000 units per reel
(EA)	TA Tape & reel option	1000 units per reel
(EB)	TB Tape & reel option	1000 units per reel
(EA)-V	TA Tape & reel option + VDE	1000 units per reel
(EB)-V	TB Tape & reel option + VDE	1000 units per reel

Package Drawing (Dimensions in mm)

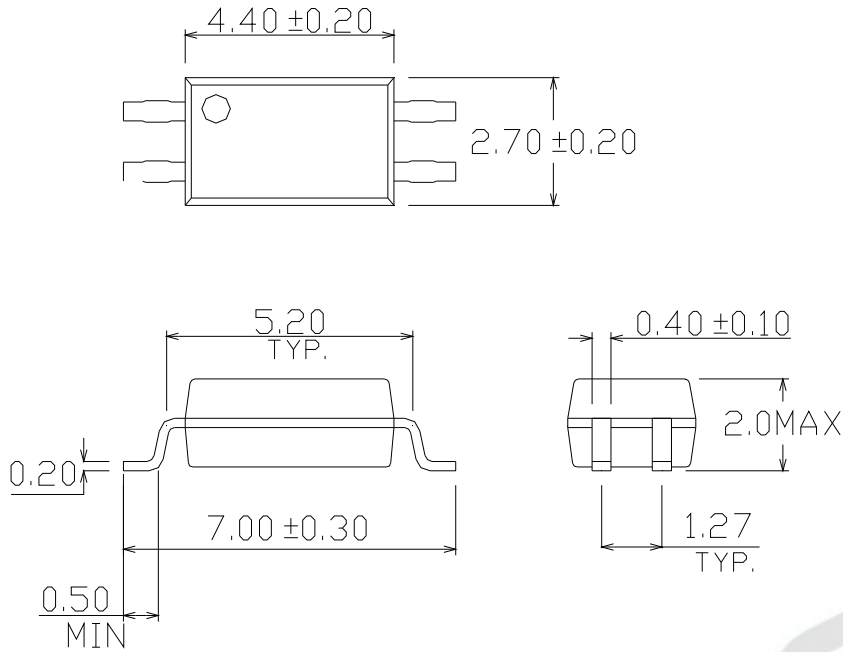

Recommended pad layout for surface mount leadform

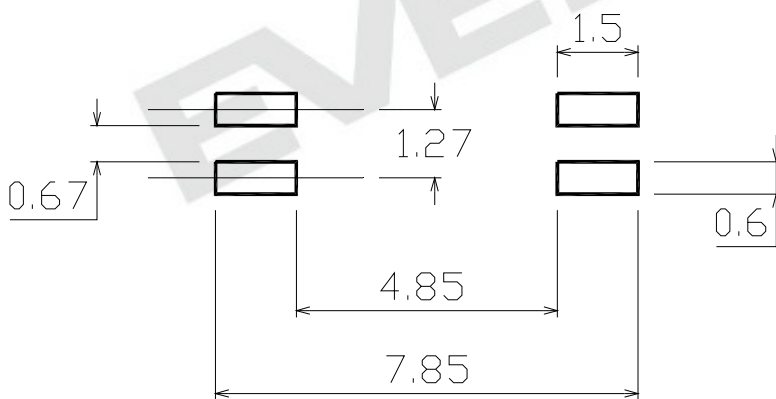

Device Marking



Notes

EL	denotes Everlight
3H7	denotes Device Number
R	denotes CTR Rank (A, B, C, D, E, F, H, I, J, K or none)
Y	denotes 1 digit Year code
WW	denotes 2 digit Week code
V	denotes VDE (optional)

EVERLIGHT

Tape & Reel Packing Specifications

Option TA

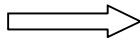
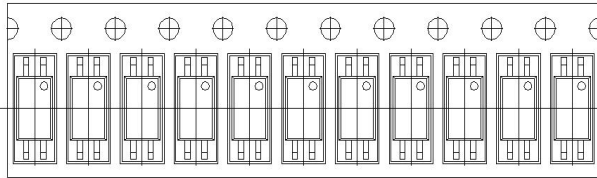

Direction of feed from reel

Option TB

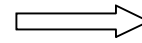
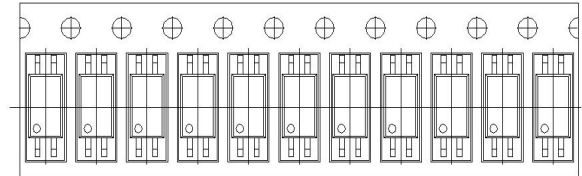

Direction of feed from reel

Tape dimensions

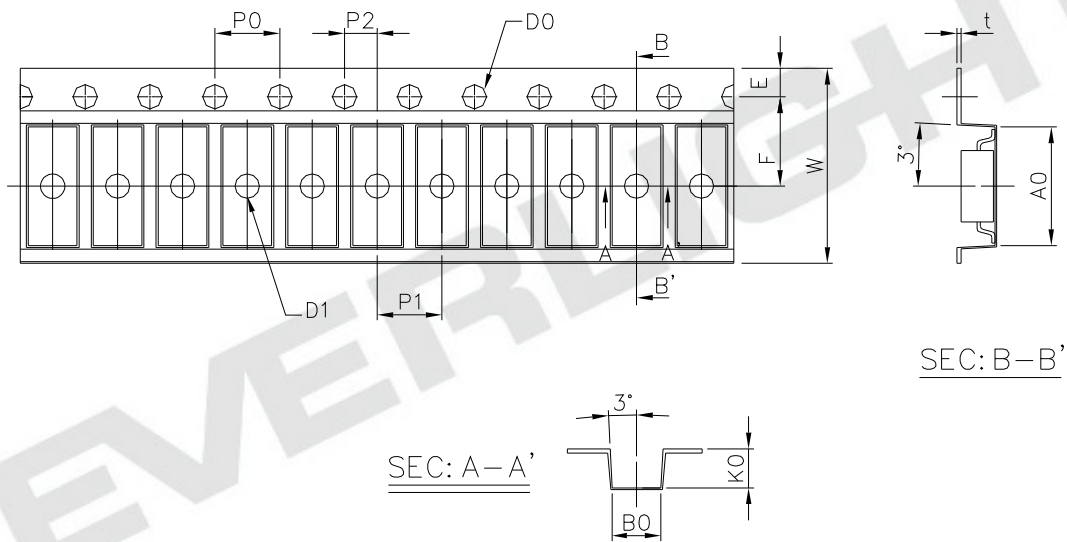

Dimension No.	A	B	Do	D1	E	F
Dimension (mm)	3.0 ± 0.1	7.3 ± 0.1	1.5 + 0.1/-0	1.5 ± 0.1	1.75 ± 0.1	5.5 ± 0.1
Dimension No.	Po	P1	P2	t	W	K
Dimension (mm)	4.0 ± 0.15	4.0 ± 0.1	2.0 ± 0.1	0.25 ± 0.03	12.0 ± 0.2	2.4 ± 0.1

Solder Reflow Temperature Profile

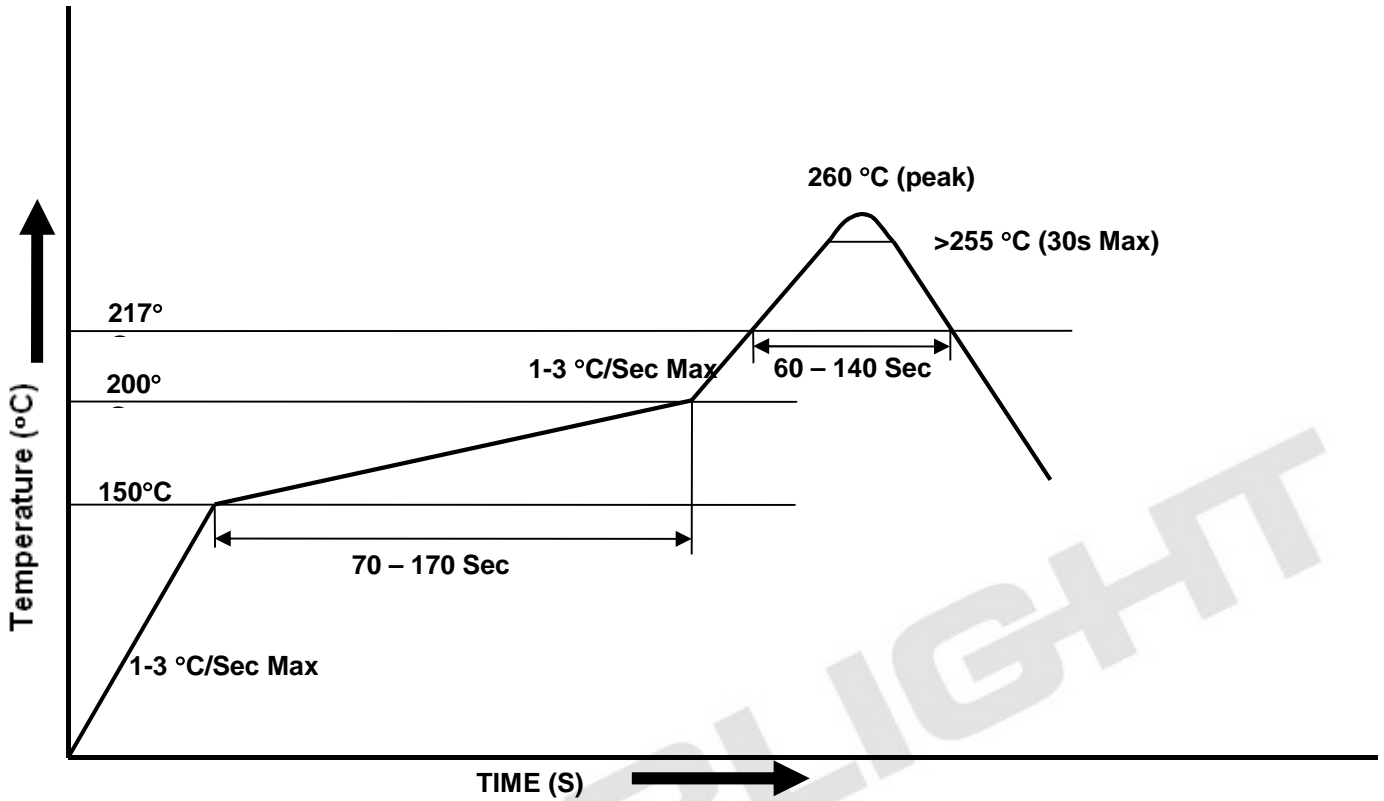

DISCLAIMER

1. The specifications in this datasheet may be changed without notice. EVERLIGHT reserves the authority on material change for above specification.
2. When using this product, please observe the absolute maximum ratings and the instructions for use as outlined in this datasheet. EVERLIGHT assumes no responsibility for any damage resulting from use of the product which does not comply with the absolute maximum ratings and the instructions included in this datasheet.
3. These specification sheets include materials protected under copyright of EVERLIGHT. Reproduction in any form is prohibited without the specific consent of EVERLIGHT.

EVERLIGHT

Looking for pricing, stock, or lifecycle information?

Click below to explore more details on WIN SOURCE:

- ⊖ [View EL3H7\(B\)\(TA\)-VG on WIN SOURCE](#)
- ⊖ [Everlight Electronics Co Ltd Information](#)

Optimize Your Supply Chain with WIN SOURCE Solutions

- ✓ Global Sourcing Solution
- ✓ Obsolete Management
- ✓ Cost Control Management
- ✓ Shortage Management
- ✓ Alternative Solution
- ✓ Excess Inventory Management