



**THE DATASHEET OF
GRM035R60J475ME15D**





< List of part numbers with package codes >
 GRM035R60J475ME15D , GRM035R60J475ME15J

Shape

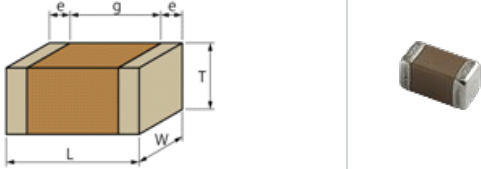

L size	0.6 ±0.09mm
W size	0.3 ±0.09mm
T size	0.5 ±0.05mm
External terminal width e	0.1 to 0.25mm
Distance between external terminals g	0.2mm min.
Size code in inch(mm)	0201 (0603M)

Notes

Measure capacitance after heat treatment.
 Derating1.
 Only for mobile devices

References

Packaging	Specifications	Minimum quantity
D	φ180mm Paper taping	10000
J	φ330mm Paper taping	50000

Mass (typ.)	
1 piece	0.57mg

Specifications

Capacitance	4.7μF ±20%
Rated voltage	6.3Vdc
Temperature characteristics (complied standard)	X5R(EIA)
Capacitance change rate	±15.0%
Temperature range of temperature characteristics	-55 to 85°C
Operating temperature range	-55 to 85°C

Attention

- 1.This datasheet is downloaded from the website of Murata Manufacturing Co., Ltd. Therefore, it's specifications are subject to change or our products in it may be discontinued without advance notice. Please check with our sales representatives or product engineers before ordering.
- 2.This datasheet has only typical specifications because there is no space for detailed specifications. Therefore, please review our product specifications or consult the approval sheet for product specifications before ordering.

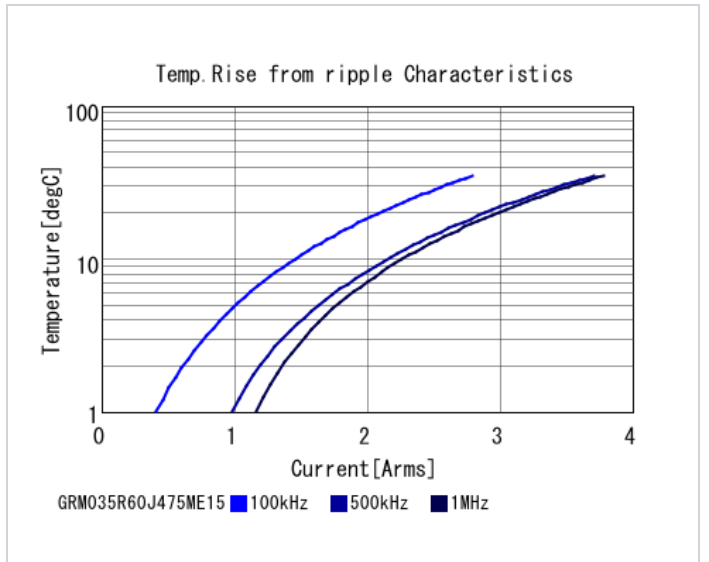
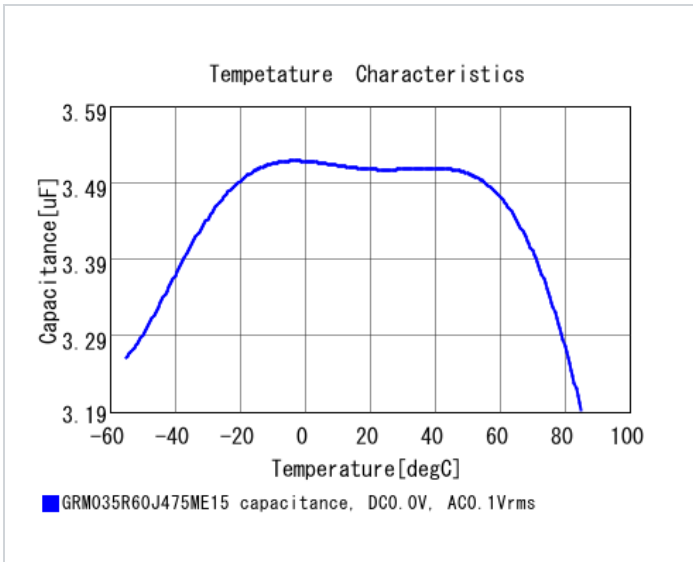
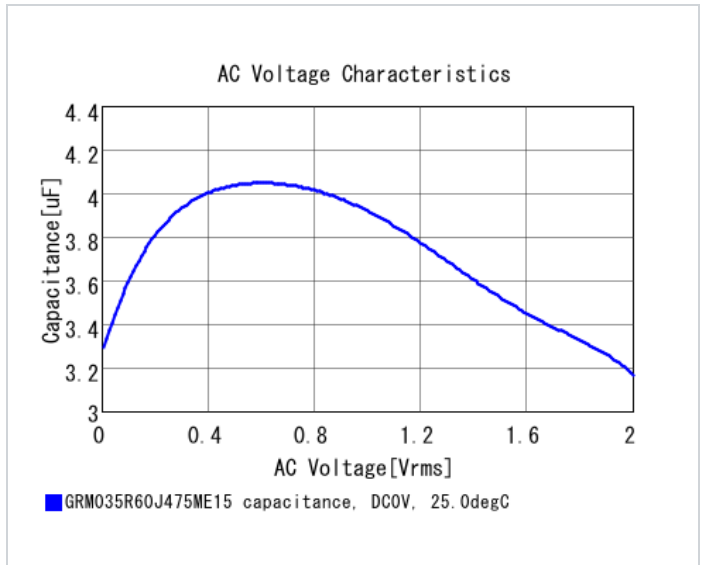
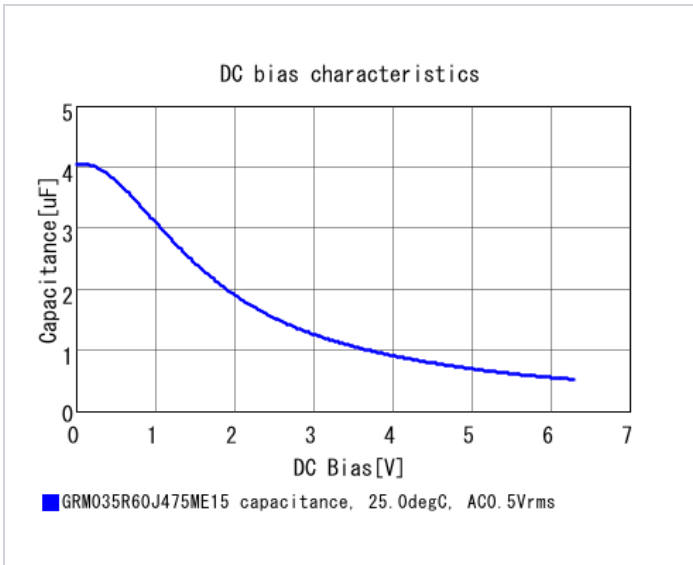
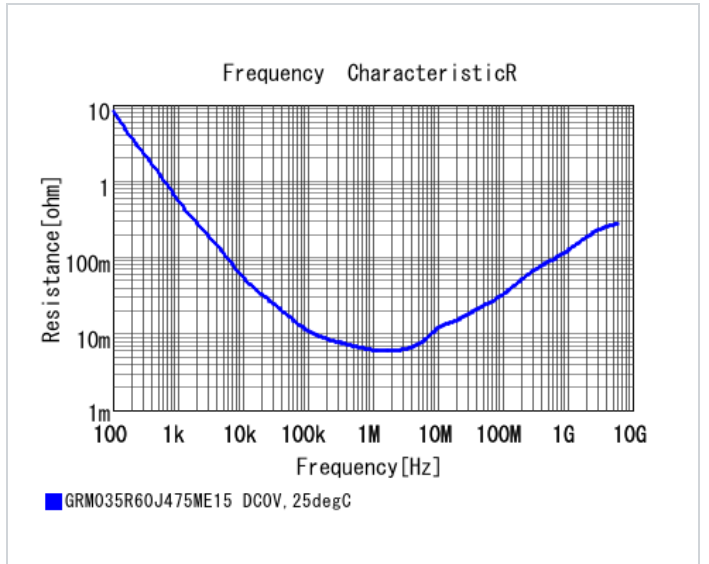
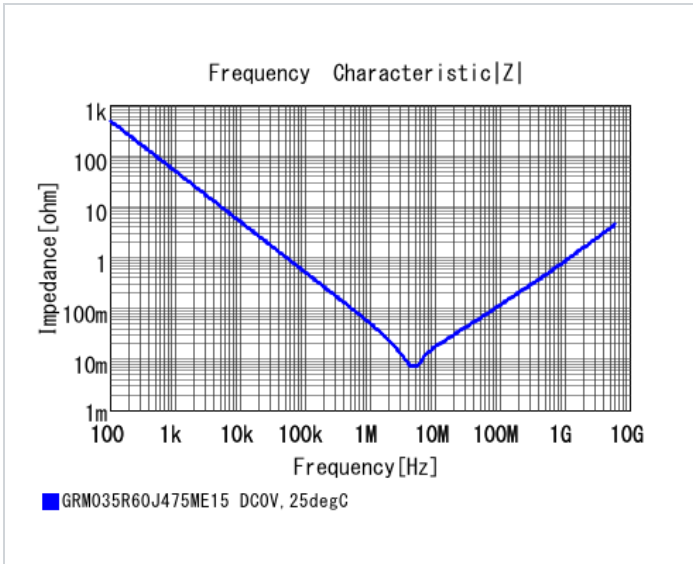

⚠ Attention

- 1.This datasheet is downloaded from the website of Murata Manufacturing Co., Ltd. Therefore, it's specifications are subject to change or our products in it may be discontinued without advance notice. Please check with our sales representatives or product engineers before ordering.
- 2.This datasheet has only typical specifications because there is no space for detailed specifications. Therefore, please review our product specifications or consult the approval sheet for product specifications before ordering.

Looking for pricing, stock, or lifecycle information?

Click below to explore more details on WIN SOURCE:

- ⊖ [View GRM035R60J475ME15D on WIN SOURCE](#)
- ⊖ [Murata Electronics North America Information](#)

Optimize Your Supply Chain with WIN SOURCE Solutions

- ✓ Global Sourcing Solution
- ✓ Obsolete Management
- ✓ Cost Control Management
- ✓ Shortage Management
- ✓ Alternative Solution
- ✓ Excess Inventory Management