



**THE DATASHEET OF
PESD5Z3.3,115**



Important notice

Dear Customer,

On 7 February 2017 the former NXP Standard Product business became a new company with the tradename **Nexperia**. Nexperia is an industry leading supplier of Discrete, Logic and PowerMOS semiconductors with its focus on the automotive, industrial, computing, consumer and wearable application markets

In data sheets and application notes which still contain NXP or Philips Semiconductors references, use the references to Nexperia, as shown below.

Instead of <http://www.nxp.com>, <http://www.philips.com/> or <http://www.semiconductors.philips.com/>, use <http://www.nexperia.com>

Instead of sales.addresses@www.nxp.com or sales.addresses@www.semiconductors.philips.com, use salesaddresses@nexperia.com (email)

Replace the copyright notice at the bottom of each page or elsewhere in the document, depending on the version, as shown below:

- © NXP N.V. (year). All rights reserved or © Koninklijke Philips Electronics N.V. (year). All rights reserved

Should be replaced with:

- © **Nexperia B.V. (year). All rights reserved.**

If you have any questions related to the data sheet, please contact our nearest sales office via e-mail or telephone (details via salesaddresses@nexperia.com). Thank you for your cooperation and understanding,

Kind regards,

Team Nexperia

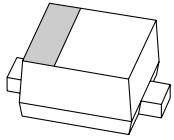

PESD5Zx series

Low capacitance unidirectional ESD protection diodes

Rev. 02 — 4 April 2008

Product data sheet

1. Product profile

1.1 General description

Low capacitance unidirectional ElectroStatic Discharge (ESD) protection diodes in a SOD523 (SC-79) ultra small and flat lead Surface-Mounted Device (SMD) plastic package designed to protect one signal line from the damage caused by ESD and other transients.

Table 1. Product overview

| Type number | Package | | Configuration |
|-------------|---------|-------|---------------|
| | NXP | JEITA | |
| PESD5Z2.5 | SOD523 | SC-79 | single |
| PESD5Z3.3 | | | |
| PESD5Z5.0 | | | |
| PESD5Z6.0 | | | |
| PESD5Z7.0 | | | |
| PESD5Z12 | | | |

1.2 Features

- ESD protection of one line
- Low diode capacitance
- Max. peak pulse power: $P_{PP} = 260 \text{ W}$
- Low clamping voltage: $V_{CL} = 15 \text{ V}$
- Low leakage current: $I_{RM} < 1 \text{ nA}$
- ESD protection up to 30 kV
- IEC 61000-4-2; level 4 (ESD)
- IEC 61000-4-5 (surge); $I_{PP} = 20 \text{ A}$

1.3 Applications

- Computers and peripherals
- Audio and video equipment
- Cellular handsets and accessories
- 10/100/1000 Mbit/s Ethernet
- Communication systems
- Portable electronics
- Subscriber Identity Module (SIM) card protection
- FireWire
- High-speed data lines

1.4 Quick reference data

Table 2. Quick reference data

$T_{amb} = 25\text{ }^{\circ}\text{C}$ unless otherwise specified.

| Symbol | Parameter | Conditions | Min | Typ | Max | Unit |
|------------------|--------------------------|------------|-------------------------------|-----|------|------|
| Per diode | | | | | | |
| V_{RWM} | reverse standoff voltage | | | | | |
| | | PESD5Z2.5 | - | - | 2.5 | V |
| | | PESD5Z3.3 | - | - | 3.3 | V |
| | | PESD5Z5.0 | - | - | 5.0 | V |
| | | PESD5Z6.0 | - | - | 6.0 | V |
| | | PESD5Z7.0 | - | - | 7.0 | V |
| | | PESD5Z12 | - | - | 12.0 | V |
| C_d | diode capacitance | | f = 1 MHz; $V_R = 0\text{ V}$ | | | |
| | | PESD5Z2.5 | - | 229 | 300 | pF |
| | | PESD5Z3.3 | - | 172 | 200 | pF |
| | | PESD5Z5.0 | - | 89 | 150 | pF |
| | | PESD5Z6.0 | - | 78 | 150 | pF |
| | | PESD5Z7.0 | - | 69 | 150 | pF |
| | | PESD5Z12 | - | 35 | 75 | pF |

2. Pinning information

Table 3. Pinning

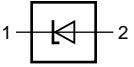
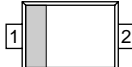
| Pin | Description | Simplified outline | Symbol |
|-----|-------------|--|--|
| 1 | cathode | [1] |  006aaa152 |
| 2 | anode |  | |

[1] The marking bar indicates the cathode.

3. Ordering information

Table 4. Ordering information

| Type number | Package | | Version |
|-------------|---------|--|---------|
| | Name | Description | |
| PESD5Z2.5 | SC-79 | plastic surface-mounted package; 2 leads | SOD523 |
| PESD5Z3.3 | | | |
| PESD5Z5.0 | | | |
| PESD5Z6.0 | | | |
| PESD5Z7.0 | | | |
| PESD5Z12 | | | |

4. Marking

Table 5. Marking codes

| Type number | Marking code |
|-------------|--------------|
| PESD5Z2.5 | N7 |
| PESD5Z3.3 | N8 |
| PESD5Z5.0 | N9 |
| PESD5Z6.0 | NA |
| PESD5Z7.0 | NB |
| PESD5Z12 | NC |

5. Limiting values

Table 6. Limiting values

In accordance with the Absolute Maximum Rating System (IEC 60134).

| Symbol | Parameter | Conditions | Min | Max | Unit |
|-------------------|----------------------|--------------------------|--------|------|------|
| Per diode | | | | | |
| P _{PP} | peak pulse power | t _p = 8/20 μs | [1][2] | | |
| | PESD5Z2.5 | | - | 260 | W |
| | PESD5Z3.3 | | - | 260 | W |
| | PESD5Z5.0 | | - | 180 | W |
| | PESD5Z6.0 | | - | 180 | W |
| | PESD5Z7.0 | | - | 180 | W |
| | PESD5Z12 | | - | 200 | W |
| I _{PP} | peak pulse current | t _p = 8/20 μs | [1][2] | | |
| | PESD5Z2.5 | | - | 20 | A |
| | PESD5Z3.3 | | - | 20 | A |
| | PESD5Z5.0 | | - | 10 | A |
| | PESD5Z6.0 | | - | 10 | A |
| | PESD5Z7.0 | | - | 10 | A |
| | PESD5Z12 | | - | 6 | A |
| Per device | | | | | |
| T _j | junction temperature | | - | 150 | °C |
| T _{amb} | ambient temperature | | -65 | +150 | °C |
| T _{stg} | storage temperature | | -65 | +150 | °C |

[1] Non-repetitive current pulse 8/20 μs exponential decay waveform according to IEC 61000-4-5.

[2] Measured from pin 1 to 2.

Table 7. ESD maximum ratings

| Symbol | Parameter | Conditions | Min | Max | Unit |
|------------------|---------------------------------|-----------------------------------|--------|------|------|
| Per diode | | | | | |
| V_{ESD} | electrostatic discharge voltage | | | | |
| | PESD5Zx series | IEC 61000-4-2 (contact discharge) | [1][2] | - 30 | kV |
| | | machine model | - | 400 | V |
| | | MIL-STD-883 (human body model) | - | 10 | kV |

[1] Device stressed with ten non-repetitive ESD pulses.

[2] Measured from pin 1 to 2.

Table 8. ESD standards compliance

| Standard | Conditions |
|---|---------------------------------|
| Per diode | |
| IEC 61000-4-2; level 4 (ESD) | > 15 kV (air); > 8 kV (contact) |
| MIL-STD-883; class 3 (human body model) | > 4 kV |

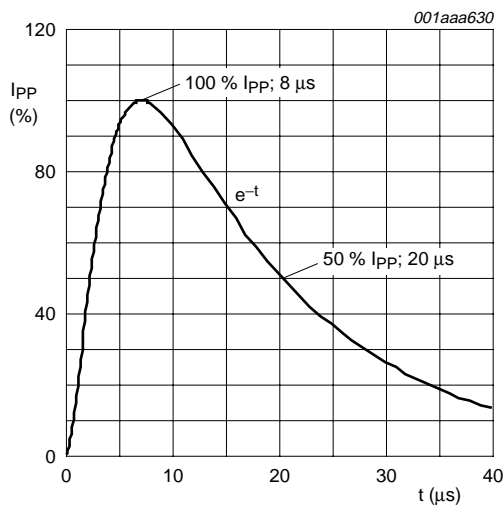

Fig 1. 8/20 μs pulse waveform according to IEC 61000-4-5

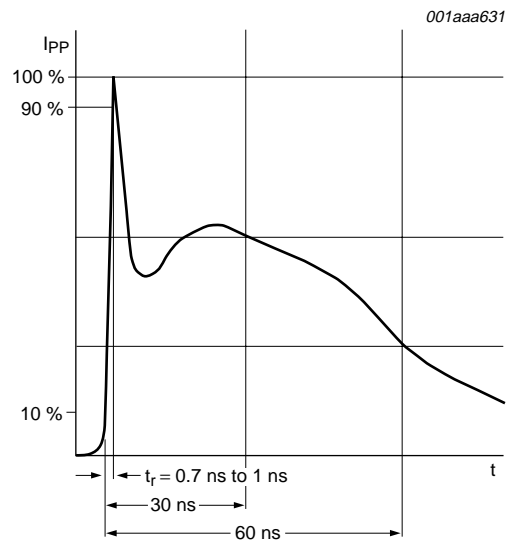

Fig 2. ESD pulse waveform according to IEC 61000-4-2

6. Characteristics

Table 9. Characteristics
T_{amb} = 25 °C unless otherwise specified.

| Symbol | Parameter | Conditions | Min | Typ | Max | Unit |
|------------------|--------------------------|---------------------------------|------------------------|-----|------|------|
| Per diode | | | | | | |
| V _{RWM} | reverse standoff voltage | | | | | |
| | PESD5Z2.5 | | - | - | 2.5 | V |
| | PESD5Z3.3 | | - | - | 3.3 | V |
| | PESD5Z5.0 | | - | - | 5.0 | V |
| | PESD5Z6.0 | | - | - | 6.0 | V |
| | PESD5Z7.0 | | - | - | 7.0 | V |
| | PESD5Z12 | | - | - | 12.0 | V |
| I _{RM} | reverse leakage current | | | | | |
| | PESD5Z2.5 | V _{RWM} = 2.5 V | - | 0.5 | 6 | μA |
| | PESD5Z3.3 | V _{RWM} = 3.3 V | - | 8 | 50 | nA |
| | PESD5Z5.0 | V _{RWM} = 5.0 V | - | 5 | 50 | nA |
| | PESD5Z6.0 | V _{RWM} = 6.0 V | - | 2 | 10 | nA |
| | PESD5Z7.0 | V _{RWM} = 7.0 V | - | < 1 | 10 | nA |
| | PESD5Z12 | V _{RWM} = 12.0 V | - | < 1 | 10 | nA |
| V _{BR} | breakdown voltage | I _R = 1 mA | | | | |
| | PESD5Z2.5 | | 4 | - | - | V |
| | PESD5Z3.3 | | 5 | - | - | V |
| | PESD5Z5.0 | | 6.2 | - | - | V |
| | PESD5Z6.0 | | 6.8 | - | - | V |
| | PESD5Z7.0 | | 7.5 | - | - | V |
| | PESD5Z12 | | 14.1 | - | - | V |
| C _d | diode capacitance | f = 1 MHz; V _R = 0 V | | | | |
| | PESD5Z2.5 | | - | 229 | 300 | pF |
| | PESD5Z3.3 | | - | 172 | 200 | pF |
| | PESD5Z5.0 | | - | 89 | 150 | pF |
| | PESD5Z6.0 | | - | 78 | 150 | pF |
| | PESD5Z7.0 | | - | 69 | 150 | pF |
| | PESD5Z12 | | - | 35 | 75 | pF |
| V _{CL} | clamping voltage | I _{PP} = 5 A | [1][2] | | | |
| | PESD5Z2.5 | | - | 8 | 9 | V |
| | PESD5Z3.3 | | - | 8 | 10 | V |
| | PESD5Z5.0 | | - | 12 | 13 | V |
| | PESD5Z6.0 | | - | 12 | 13 | V |
| | PESD5Z7.0 | | - | 14 | 15 | V |
| | PESD5Z12 | | - | 27 | 30 | V |

Table 9. Characteristics ...continued

$T_{amb} = 25\text{ }^{\circ}\text{C}$ unless otherwise specified.

| Symbol | Parameter | Conditions | Min | Typ | Max | Unit |
|-----------|-------------------------|------------------------|--------|-----|-----|----------|
| V_{CL} | clamping voltage | | [1][2] | | | |
| | PESD5Z2.5 | $I_{PP} = 20\text{ A}$ | - | - | 15 | V |
| | PESD5Z3.3 | $I_{PP} = 20\text{ A}$ | - | - | 18 | V |
| | PESD5Z5.0 | $I_{PP} = 10\text{ A}$ | - | - | 18 | V |
| | PESD5Z6.0 | $I_{PP} = 10\text{ A}$ | - | - | 18 | V |
| | PESD5Z7.0 | $I_{PP} = 10\text{ A}$ | - | - | 19 | V |
| | PESD5Z12 | $I_{PP} = 6\text{ A}$ | - | - | 35 | V |
| r_{dif} | differential resistance | $I_R = 5\text{ mA}$ | | | | |
| | PESD5Z2.5 | | - | - | 60 | Ω |
| | PESD5Z3.3 | | - | - | 10 | Ω |
| | PESD5Z5.0 | | - | - | 15 | Ω |
| | PESD5Z6.0 | | - | - | 15 | Ω |
| | PESD5Z7.0 | | - | - | 15 | Ω |
| | PESD5Z12 | | - | - | 40 | Ω |

[1] Non-repetitive current pulse 8/20 μs exponential decay waveform according to IEC 61000-4-5.

[2] Measured from pin 1 to 2.

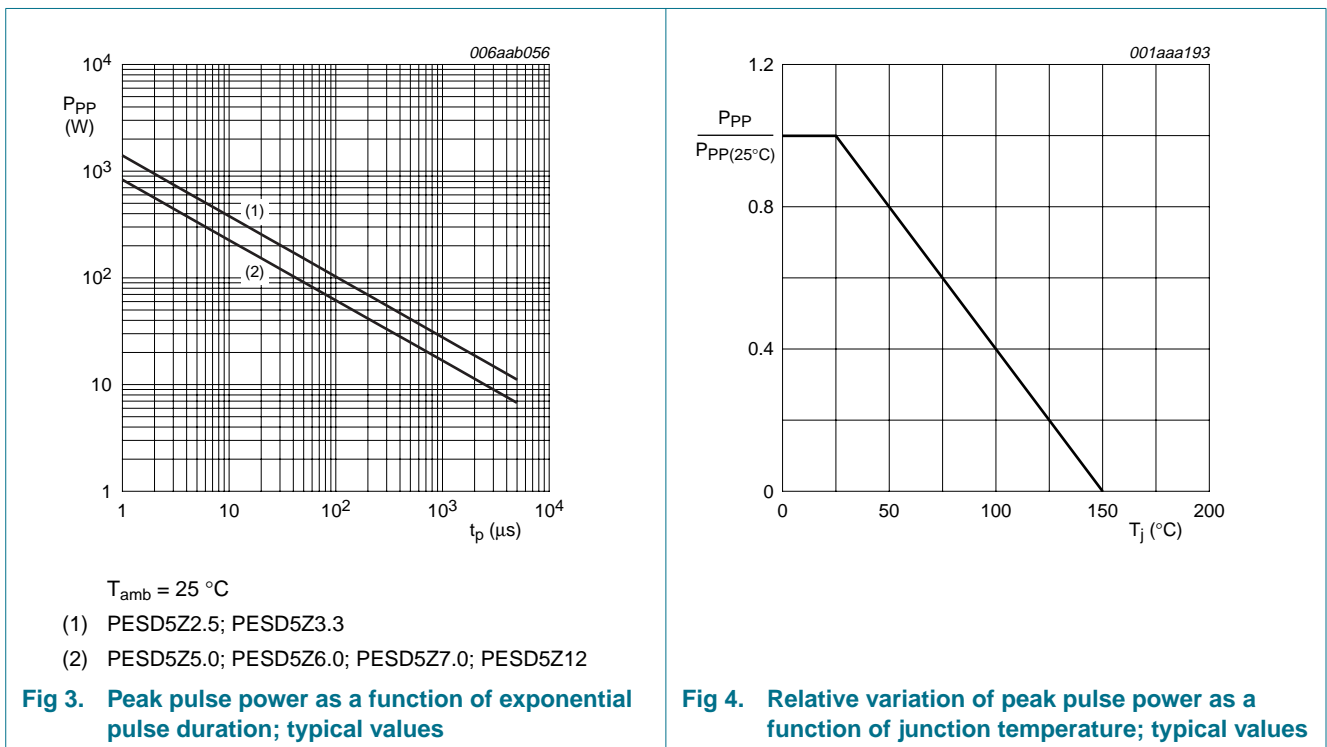

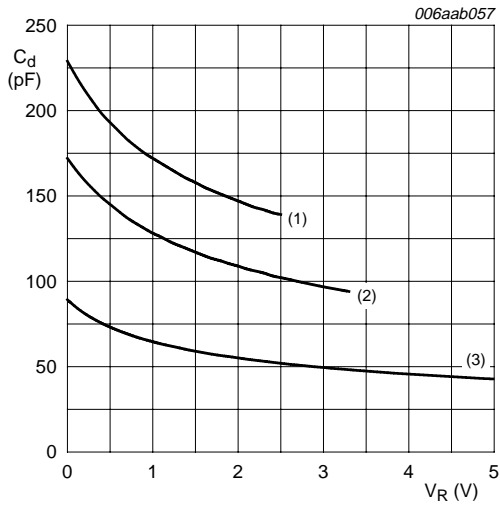

f = 1 MHz; T_{amb} = 25 °C

- (1) PESD5Z2.5
- (2) PESD5Z3.3
- (3) PESD5Z5.0

Fig 5. Diode capacitance as a function of reverse voltage; typical values

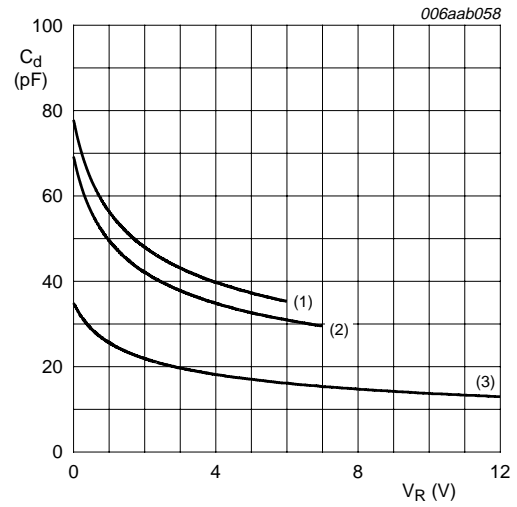

f = 1 MHz; T_{amb} = 25 °C

- (1) PESD5Z6.0
- (2) PESD5Z7.0
- (3) PESD5Z12

Fig 6. Diode capacitance as a function of reverse voltage; typical values

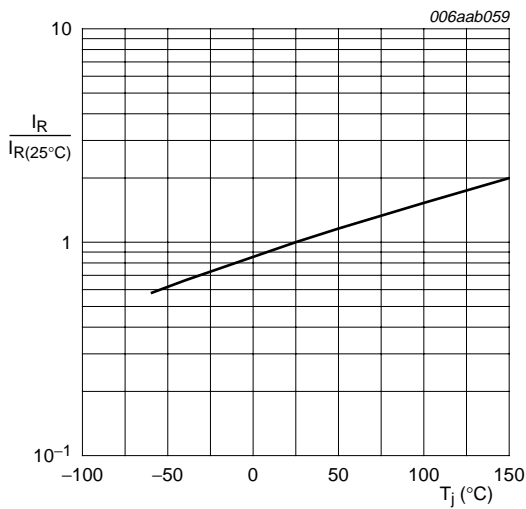

PESD5Z2.5; V_{RWM} = 2.5 V
 PESD5Z3.3; V_{RWM} = 3.3 V
 I_R is less than 50 nA at 150 °C for:
 PESD5Z5.0; V_{RWM} = 5.0 V
 PESD5Z6.0; V_{RWM} = 6.0 V
 PESD5Z7.0; V_{RWM} = 7.0 V
 PESD5Z12; V_{RWM} = 12.0 V

Fig 7. Relative variation of reverse current as a function of junction temperature; typical values

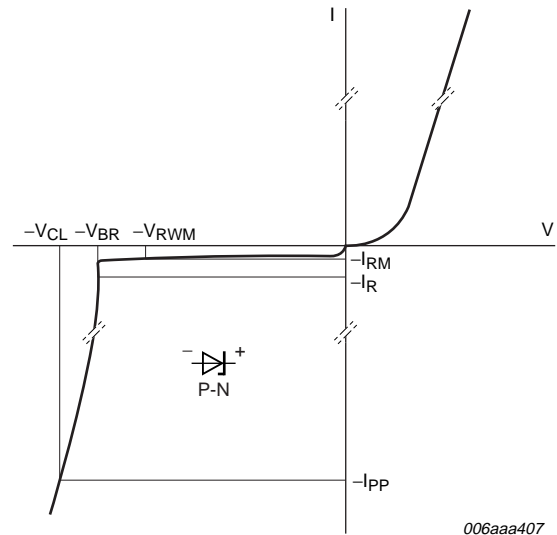
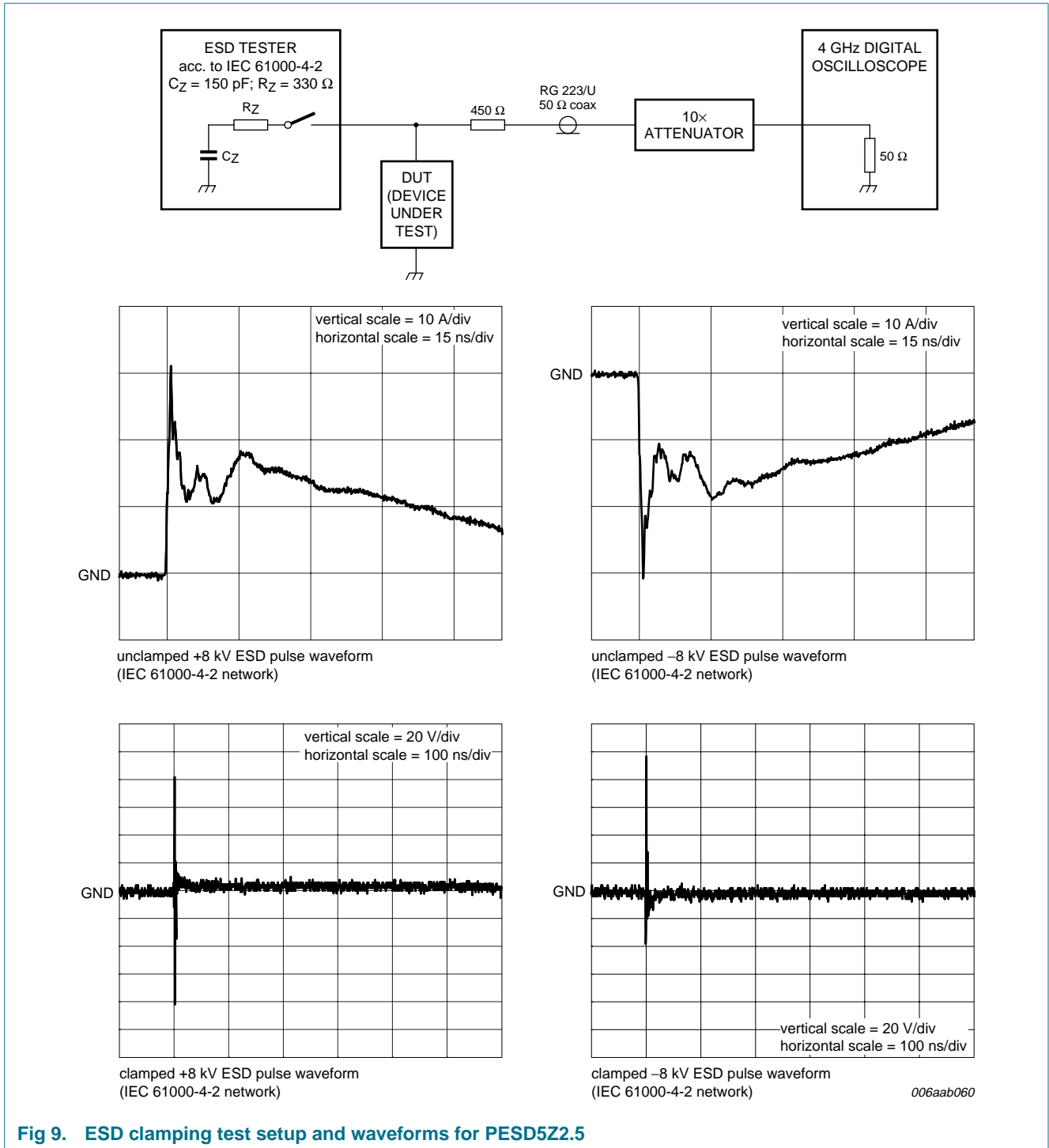

Fig 8. V-I characteristics for a unidirectional ESD protection diode



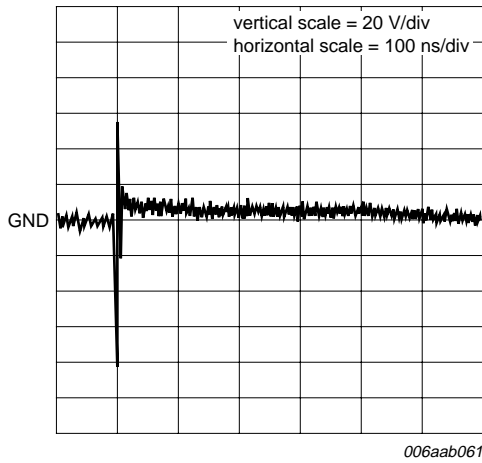

Fig 10. PESD5Z3.3: Clamped +8 kV ESD pulse waveform (IEC 61000-4-2 network)

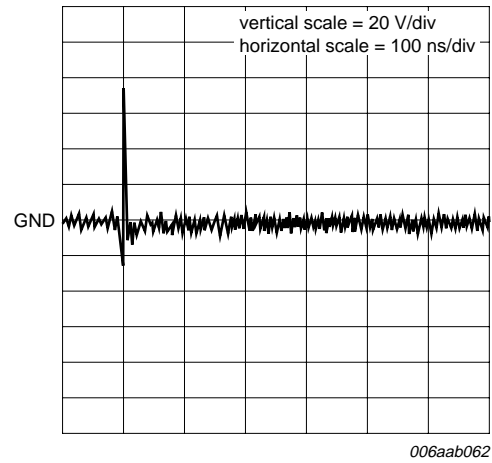

Fig 11. PESD5Z3.3: Clamped -8 kV ESD pulse waveform (IEC 61000-4-2 network)

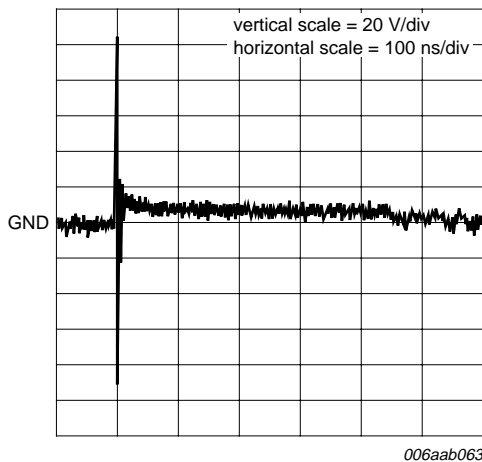

Fig 12. PESD5Z5.0: Clamped +8 kV ESD pulse waveform (IEC 61000-4-2 network)

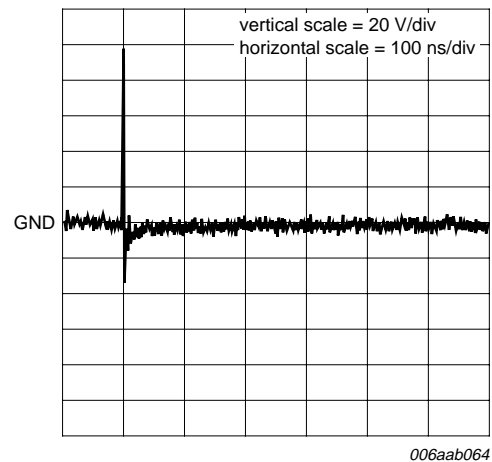

Fig 13. PESD5Z5.0: Clamped -8 kV ESD pulse waveform (IEC 61000-4-2 network)

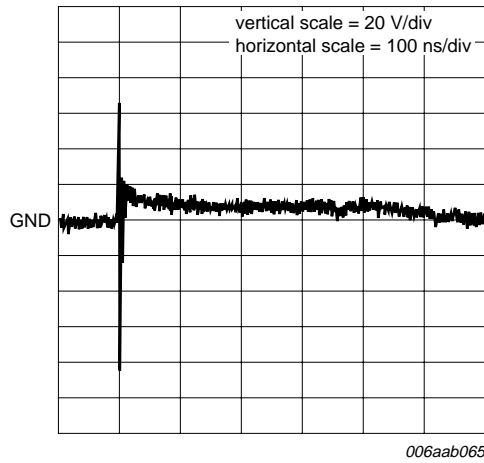

Fig 14. PESD5Z6.0: Clamped +8 kV ESD pulse waveform (IEC 61000-4-2 network)

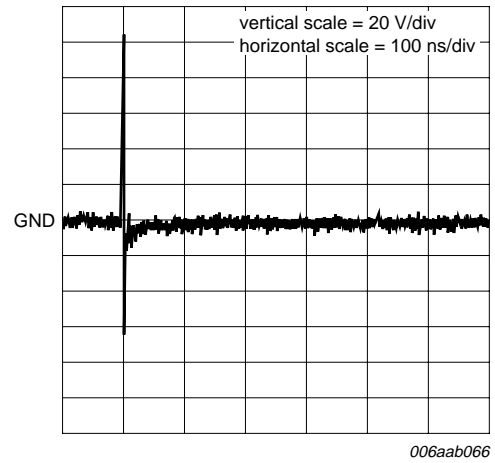

Fig 15. PESD5Z6.0: Clamped -8 kV ESD pulse waveform (IEC 61000-4-2 network)

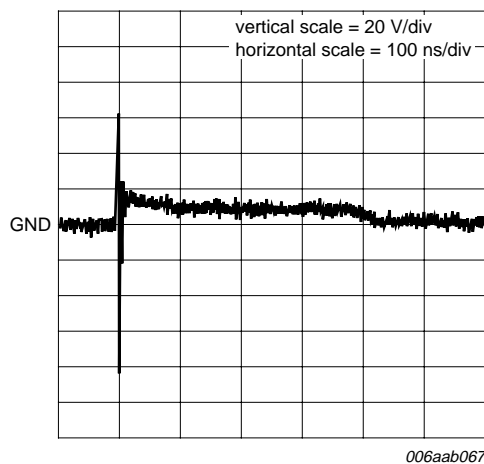

Fig 16. PESD5Z7.0: Clamped +8 kV ESD pulse waveform (IEC 61000-4-2 network)

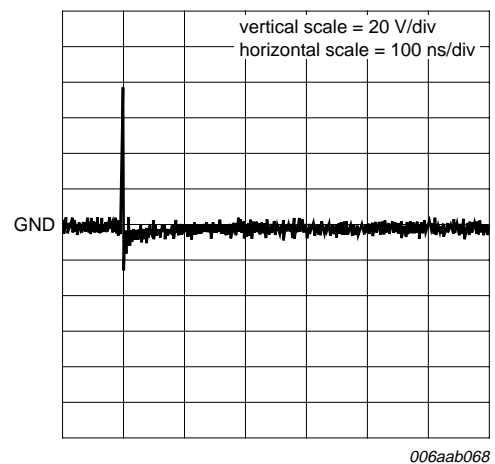
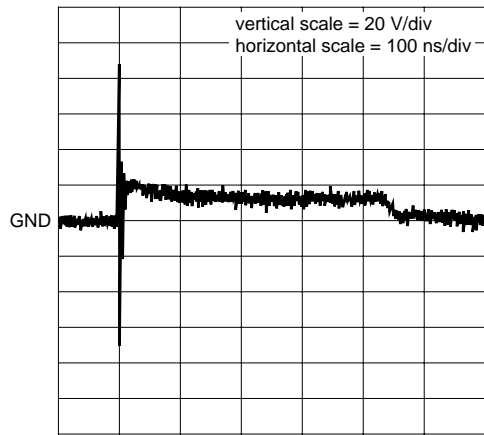
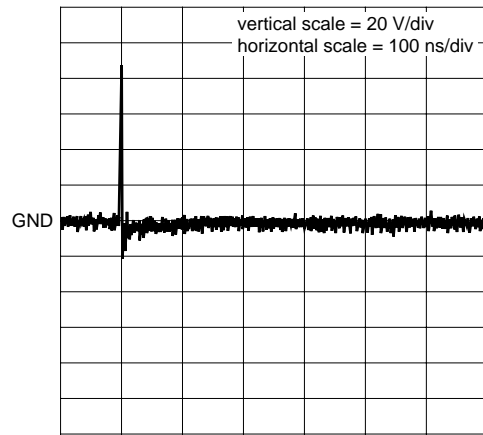

Fig 17. PESD5Z7.0: Clamped -8 kV ESD pulse waveform (IEC 61000-4-2 network)



006aab069

Fig 18. PESD5Z12: Clamped +8 kV ESD pulse waveform (IEC 61000-4-2 network)



006aab070

Fig 19. PESD5Z12: Clamped -8 kV ESD pulse waveform (IEC 61000-4-2 network)

7. Application information

The PESD5Zx series is designed for the protection of one unidirectional data or signal line from the damage caused by ESD and surge pulses. The device may be used on lines where the signal polarities are either positive or negative with respect to ground. The PESD5Zx series provides a surge capability of 260 W per line for an 8/20 μ s waveform.

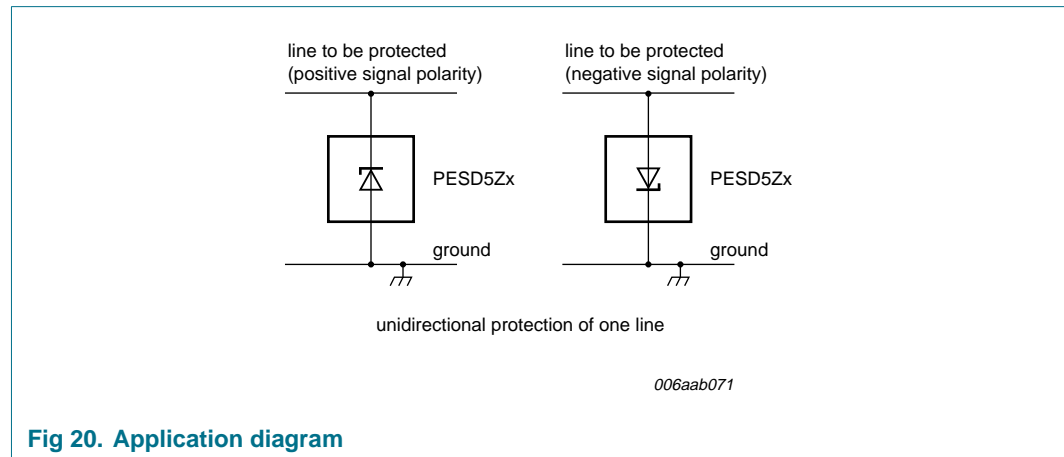

Fig 20. Application diagram

Circuit board layout and protection device placement

Circuit board layout is critical for the suppression of ESD, Electrical Fast Transient (EFT) and surge transients. The following guidelines are recommended:

1. Place the PESD5Zx as close to the input terminal or connector as possible.
2. The path length between the PESD5Zx and the protected line should be minimized.
3. Keep parallel signal paths to a minimum.
4. Avoid running protected conductors in parallel with unprotected conductors.
5. Minimize all Printed-Circuit Board (PCB) conductive loops including power and ground loops.
6. Minimize the length of the transient return path to ground.
7. Avoid using shared transient return paths to a common ground point.
8. Ground planes should be used whenever possible. For multilayer PCBs, use ground vias.

8. Package outline

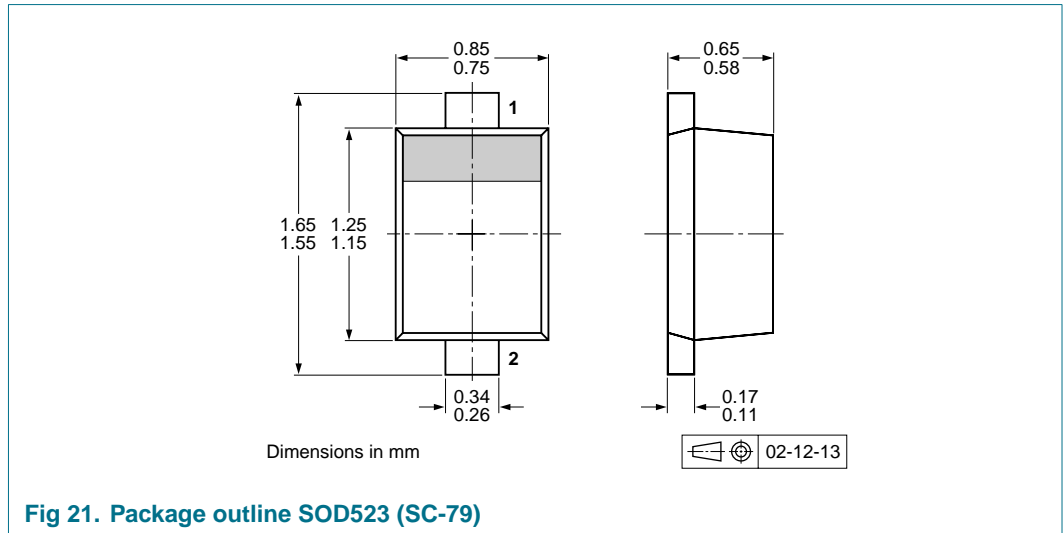

9. Packing information

Table 10. Packing methods

The indicated -xxx are the last three digits of the 12NC ordering code.^[1]

| Type number | Package | Description | Packing quantity | | |
|-------------|---------|--------------------------------|------------------|------|-------|
| | | | 3000 | 8000 | 10000 |
| PESD5Z2.5 | SOD523 | 2 mm pitch, 8 mm tape and reel | - | -315 | - |
| | | 4 mm pitch, 8 mm tape and reel | -115 | - | -135 |
| PESD5Z3.3 | SOD523 | 2 mm pitch, 8 mm tape and reel | - | -315 | - |
| | | 4 mm pitch, 8 mm tape and reel | -115 | - | -135 |
| PESD5Z5.0 | SOD523 | 2 mm pitch, 8 mm tape and reel | - | -315 | - |
| | | 4 mm pitch, 8 mm tape and reel | -115 | - | -135 |
| PESD5Z6.0 | SOD523 | 2 mm pitch, 8 mm tape and reel | - | -315 | - |
| | | 4 mm pitch, 8 mm tape and reel | -115 | - | -135 |
| PESD5Z7.0 | SOD523 | 2 mm pitch, 8 mm tape and reel | - | -315 | - |
| | | 4 mm pitch, 8 mm tape and reel | -115 | - | -135 |
| PESD5Z12 | SOD523 | 2 mm pitch, 8 mm tape and reel | - | -315 | - |
| | | 4 mm pitch, 8 mm tape and reel | -115 | - | -135 |

[1] For further information and the availability of packing methods, see [Section 13](#).

10. Soldering

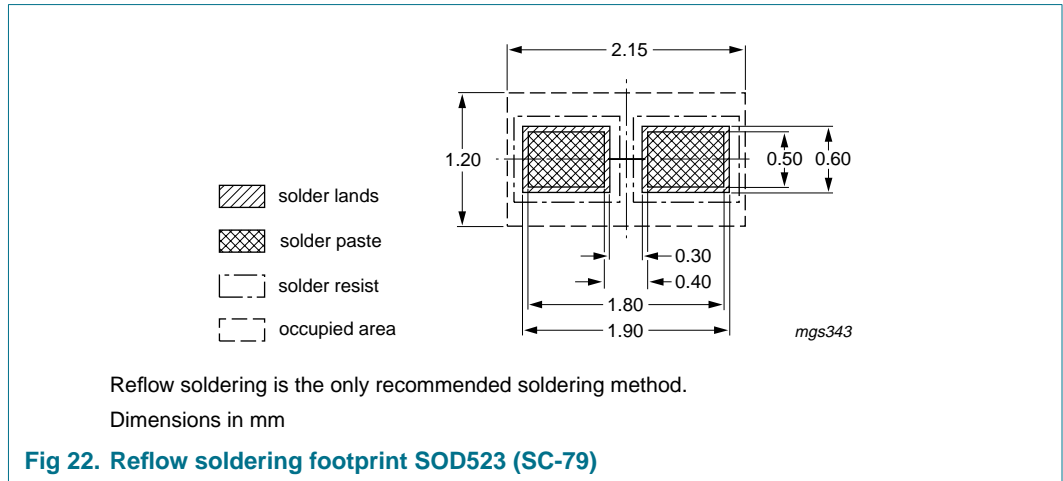

11. Revision history

Table 11. Revision history

| Document ID | Release date | Data sheet status | Change notice | Supersedes |
|----------------|--|--------------------|---------------|---------------|
| PESD5ZX_SER_2 | 20080404 | Product data sheet | - | PESD5ZX_SER_1 |
| Modifications: | • Table 10 : Type number updated to PESD5Z12 | | | |
| PESD5ZX_SER_1 | 20070813 | Product data sheet | - | - |

12. Legal information

12.1 Data sheet status

| Document status ^{[1][2]} | Product status ^[3] | Definition |
|-----------------------------------|-------------------------------|---|
| Objective [short] data sheet | Development | This document contains data from the objective specification for product development. |
| Preliminary [short] data sheet | Qualification | This document contains data from the preliminary specification. |
| Product [short] data sheet | Production | This document contains the product specification. |

[1] Please consult the most recently issued document before initiating or completing a design.

[2] The term 'short data sheet' is explained in section "Definitions".

[3] The product status of device(s) described in this document may have changed since this document was published and may differ in case of multiple devices. The latest product status information is available on the Internet at URL <http://www.nxp.com>.

12.2 Definitions

Draft — The document is a draft version only. The content is still under internal review and subject to formal approval, which may result in modifications or additions. NXP Semiconductors does not give any representations or warranties as to the accuracy or completeness of information included herein and shall have no liability for the consequences of use of such information.

Short data sheet — A short data sheet is an extract from a full data sheet with the same product type number(s) and title. A short data sheet is intended for quick reference only and should not be relied upon to contain detailed and full information. For detailed and full information see the relevant full data sheet, which is available on request via the local NXP Semiconductors sales office. In case of any inconsistency or conflict with the short data sheet, the full data sheet shall prevail.

12.3 Disclaimers

General — Information in this document is believed to be accurate and reliable. However, NXP Semiconductors does not give any representations or warranties, expressed or implied, as to the accuracy or completeness of such information and shall have no liability for the consequences of use of such information.

Right to make changes — NXP Semiconductors reserves the right to make changes to information published in this document, including without limitation specifications and product descriptions, at any time and without notice. This document supersedes and replaces all information supplied prior to the publication hereof.

Suitability for use — NXP Semiconductors products are not designed, authorized or warranted to be suitable for use in medical, military, aircraft, space or life support equipment, nor in applications where failure or

malfunction of an NXP Semiconductors product can reasonably be expected to result in personal injury, death or severe property or environmental damage. NXP Semiconductors accepts no liability for inclusion and/or use of NXP Semiconductors products in such equipment or applications and therefore such inclusion and/or use is at the customer's own risk.

Applications — Applications that are described herein for any of these products are for illustrative purposes only. NXP Semiconductors makes no representation or warranty that such applications will be suitable for the specified use without further testing or modification.

Limiting values — Stress above one or more limiting values (as defined in the Absolute Maximum Ratings System of IEC 60134) may cause permanent damage to the device. Limiting values are stress ratings only and operation of the device at these or any other conditions above those given in the Characteristics sections of this document is not implied. Exposure to limiting values for extended periods may affect device reliability.

Terms and conditions of sale — NXP Semiconductors products are sold subject to the general terms and conditions of commercial sale, as published at <http://www.nxp.com/profile/terms>, including those pertaining to warranty, intellectual property rights infringement and limitation of liability, unless explicitly otherwise agreed to in writing by NXP Semiconductors. In case of any inconsistency or conflict between information in this document and such terms and conditions, the latter will prevail.

No offer to sell or license — Nothing in this document may be interpreted or construed as an offer to sell products that is open for acceptance or the grant, conveyance or implication of any license under any copyrights, patents or other industrial or intellectual property rights.

12.4 Trademarks

Notice: All referenced brands, product names, service names and trademarks are the property of their respective owners.

13. Contact information

For additional information, please visit: <http://www.nxp.com>

For sales office addresses, send an email to: salesaddresses@nxp.com

14. Contents

1 Product profile 1

1.1 General description 1

1.2 Features 1

1.3 Applications 1

1.4 Quick reference data 2

2 Pinning information 2

3 Ordering information 2

4 Marking 3

5 Limiting values 3

6 Characteristics 5

7 Application information 12

8 Package outline 13

9 Packing information 13

10 Soldering 14

11 Revision history 15

12 Legal information 16

12.1 Data sheet status 16

12.2 Definitions 16

12.3 Disclaimers 16

12.4 Trademarks 16

13 Contact information 16

14 Contents 17

Please be aware that important notices concerning this document and the product(s) described herein, have been included in section 'Legal information'.



© NXP B.V. 2008.

All rights reserved.

For more information, please visit: <http://www.nxp.com>



For sales office addresses, please send an email to: salesaddresses@nxp.com

Date of release: 4 April 2008

Document identifier: PESD5ZX_SER_2

Looking for pricing, stock, or lifecycle information?

Click below to explore more details on WIN SOURCE:

-  [View PESD5Z3.3,115 on WIN SOURCE](#)
-  [Nexperia USA Inc. Information](#)

Optimize Your Supply Chain with WIN SOURCE Solutions

-  Global Sourcing Solution
-  Obsolete Management
-  Cost Control Management
-  Shortage Management
-  Alternative Solution
-  Excess Inventory Management