



**THE DATASHEET OF
ZEN098V230A16LS**



POLYZEN DEVICES

Polymer Protected Zener Diode

PolyZen devices are polymer-enhanced, precision Zener diodes. They offer resettable protection against multi-Watt fault events without the need for multi-Watt heat sinks.

The Zener diode used for voltage clamping a PolyZen device was selected due to its relatively flat voltage vs. current response. This helps improve output voltage clamping, even when input voltage is high and diode currents are large.

An advanced feature of the PolyZen device is that the Zener diode is thermally coupled to a resistively non-linear, PPTC (polymer positive temperature coefficient) layer. This PPTC layer is fully integrated into the device and is electrically in series between V_{IN} and the diode clamped V_{OUT} .

This advanced PPTC layer responds to either extended diode heating or overcurrent events by transitioning from a low to high resistance state, also known as “tripping.” A tripped PPTC will limit current and generate voltage drop. It helps to protect both the Zener diode and the follow-on electronics and effectively increases the diode’s power handling capability.

The polymer-enhanced Zener diode helps protect sensitive portable electronics from damage caused by inductive voltage spikes, voltage transients, incorrect power supplies and reverse bias. These devices are particularly suitable for portable electronics and other low-power DC devices.



BENEFITS

- Stable Zener diode helps shield downstream electronics from overvoltage and reverse bias
- Trip events shut out overvoltage and reverse bias sources
- Analog nature of trip events helps minimize damage from upstream inductive spikes
- Minimal power dissipation requirements
- Single component placement

FEATURES

- Overvoltage transient suppression
- Stable V_Z vs. fault current
- Time delayed, overvoltage trip
- Time delayed, reverse bias trip

APPLICATIONS

- DC power port protection in portable electronics
- DC power port protection for systems using barrel jacks for power input
- Internal overvoltage and transient suppression
- DC output voltage regulation
- Tablet PCs and portable electronics

- Multi-Watt power handling capability
- Integrated device construction
- RoHS compliant
- Halogen free
(refers to: Br \geq 900ppm, Cl \geq 900ppm, Br+Cl \geq 1500ppm)

PolyZen Devices

Polymer Protected Zener Diode

Figure PZ1 – Typical Application Block Diagram

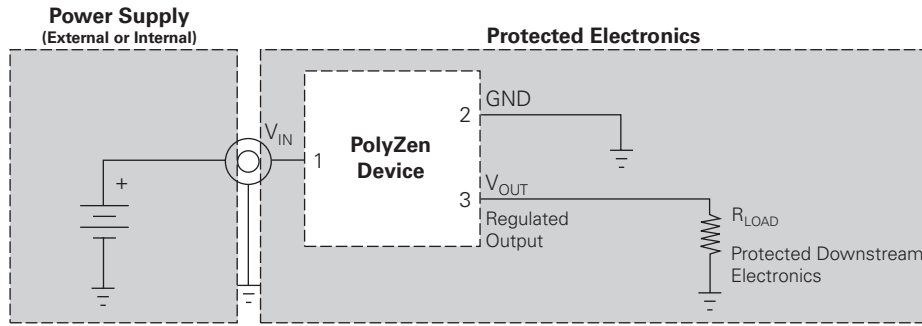

Table PZ1 – Electrical Characteristics

(Performance ratings @ 25°C unless otherwise specified)

Part Number	V_Z (V)			I_{ZT} (A)	I_{HOLD} @ 20°C (A)	R_{TYP} (Ω)	R_{1MAX} (Ω)	$V_{INT MAX}$		$I_{FLT MAX}$	
	Min	Typ	Max					$V_{INT MAX}$ (V)	Test Current (A)	$I_{FLT MAX}$ (A)	Test Voltage (V)
ZEN056V130A24LS	5.45	5.60	5.75	0.10	1.30	0.12	0.16	24	3	+10/-40	+24/-16
ZEN059V130A24LS†	5.80	5.90	6.00	0.10	1.30	0.12	0.15	24	3	+6/-40	+24/-16
ZEN065V130A24LS	6.35	6.50	6.65	0.10	1.30	0.12	0.16	24	3	+6/-40	+24/-16
ZEN098V130A24LS	9.60	9.80	10.00	0.10	1.30	0.12	0.16	24	3	+3.5/-40	+24/-16
ZEN132V130A24LS	13.20	13.40	13.60	0.10	1.30	0.12	0.16	24	3	+2/-40	+24/-16
ZEN164V130A24LS	16.10	16.40	16.60	0.10	1.30	0.12	0.16	24	3	+1.25/-40	+24/-16
ZEN056V230A16LS	5.45	5.60	5.75	0.10	2.30	0.04	0.06	16	5	+5/-40	+16/-12
ZEN065V230A16LS	6.35	6.50	6.65	0.10	2.30	0.04	0.06	16	5	+3.5/-40	+16/-12
ZEN098V230A16LS	9.60	9.80	10.00	0.10	2.30	0.04	0.06	16	5	+3.5/-40	+16/-12
ZEN132V230A16LS	13.20	13.40	13.60	0.10	2.30	0.04	0.06	16	5	+2/-40	+20/-12
ZEN056V075A48LS	5.45	5.60	5.75	0.10	0.75	0.28	0.45	48	3	+10/-40	+48/-16
ZEN132V075A48LS	13.20	13.40	13.60	0.10	0.75	0.28	0.45	48	3	+2/-40	+48/-16
ZEN056V115A24LS	5.45	5.60	5.75	0.10	1.15	0.15	0.18	24	3	+10/-40	+24/-16
NEW ZEN056V130A16YM	5.35	5.60	5.85	0.10	1.30	0.110	0.160	14	3	+3/-40	+16/-12
NEW ZEN056V175A12YM	5.35	5.60	5.85	0.10	1.75	0.050	0.095	12	4	+3/-40	+12/-12
NEW ZEN132V130A16YM	13.20	13.40	13.80	0.10	1.30	0.110	0.160	14	3	+1/-40	+20/-12
NEW ZEN132V175A12YM	13.20	13.40	13.80	0.10	1.75	0.050	0.095	12	4	+1/-40	+20/-12
NEW ZEN056V130A24YC	5.35	5.60	5.85	0.10	1.30	0.110	0.170	24	3	+4/-40	+24/-16
NEW ZEN056V230A16YC	5.35	5.60	5.85	0.10	2.30	0.040	0.070	16	5	+3/-40	+16/-12
NEW ZEN056V260A16YC	5.35	5.60	5.85	0.10	2.60	0.040	0.055	16	5	+3/-40	+16/-12
NEW ZEN132V130A24YC	13.20	13.40	13.80	0.10	1.30	0.110	0.170	24	3	+1/-40	+24/-16
NEW ZEN132V230A16YC	13.20	13.40	13.80	0.10	2.30	0.040	0.070	16	5	+1/-40	+20/-12
NEW ZEN132V260A16YC	13.20	13.40	13.80	0.10	2.60	0.040	0.055	16	5	+1/-40	+20/-12

LS module height is 1.7mm typical. YM module height is 1.2mm typical. YC module

Table PZ2 – Definition of Terms

V_Z	Zener clamping voltage measured at current I_{ZT} and 20°C.
I_{ZT}	Test current at which V_Z is measured.
I_{HOLD}	Maximum steady state current I_{PTC} that will not generate a trip event at the specified temperature. Ratings assume $I_{FLT} = 0A$.
R_{TYP}	Typical resistance between V_{IN} and V_{OUT} pins when the device is at room temperature.
R_{1MAX}	The maximum resistance between V_{IN} and V_{OUT} pins, at room temperature, one hour after first trip or after reflow soldering.
I_{FLT}	Current flowing through the Zener diode.
$I_{FLT MAX}$	Maximum RMS fault current the Zener diode component of the device can withstand and remain resettable; testing is conducted at rated voltage with no load connected to V_{OUT} .
$V_{INT MAX}$	The voltage ($V_{IN} - V_{OUT}$ "post trip") at which typical qualification devices (98% devices, 95% confidence) survived at least 100 trip cycles and 24 hours trip endurance when "tripped" at the specified voltage and current (I_{PTC}).
I_{PTC}	Current flowing through the PPTC portion of the circuit.
I_{OUT}	Current flowing out the V_{OUT} pin of the device.
Trip Event	A condition where the PPTC transitions to a high resistance state, thereby limiting I_{PTC} , and significantly increasing the voltage drop between V_{IN} and V_{OUT} .

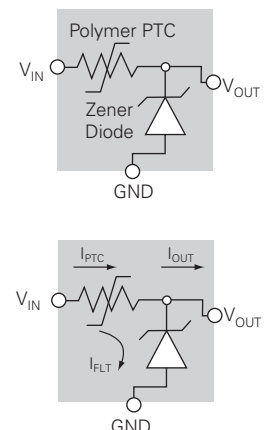

PolyZen Devices

Polymer Protected Zener Diode

Figures PZ2-PZ9 – Typical Performance Curves for PolyZen Devices - LS Series

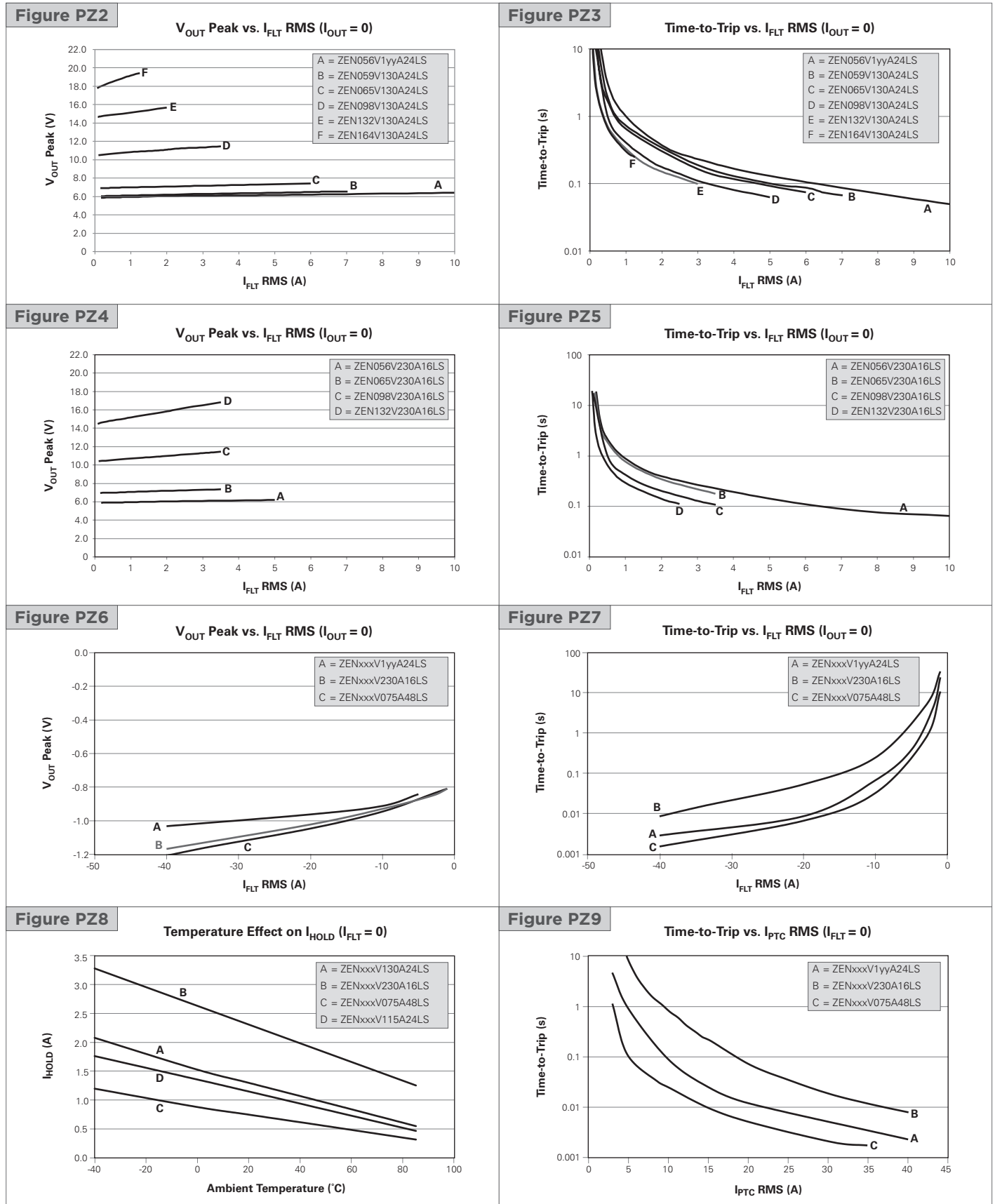

PolyZen Devices

Polymer Protected Zener Diode

Figures PZ10-PZ15 – Typical Performance Curves for PolyZen Devices -YM Series

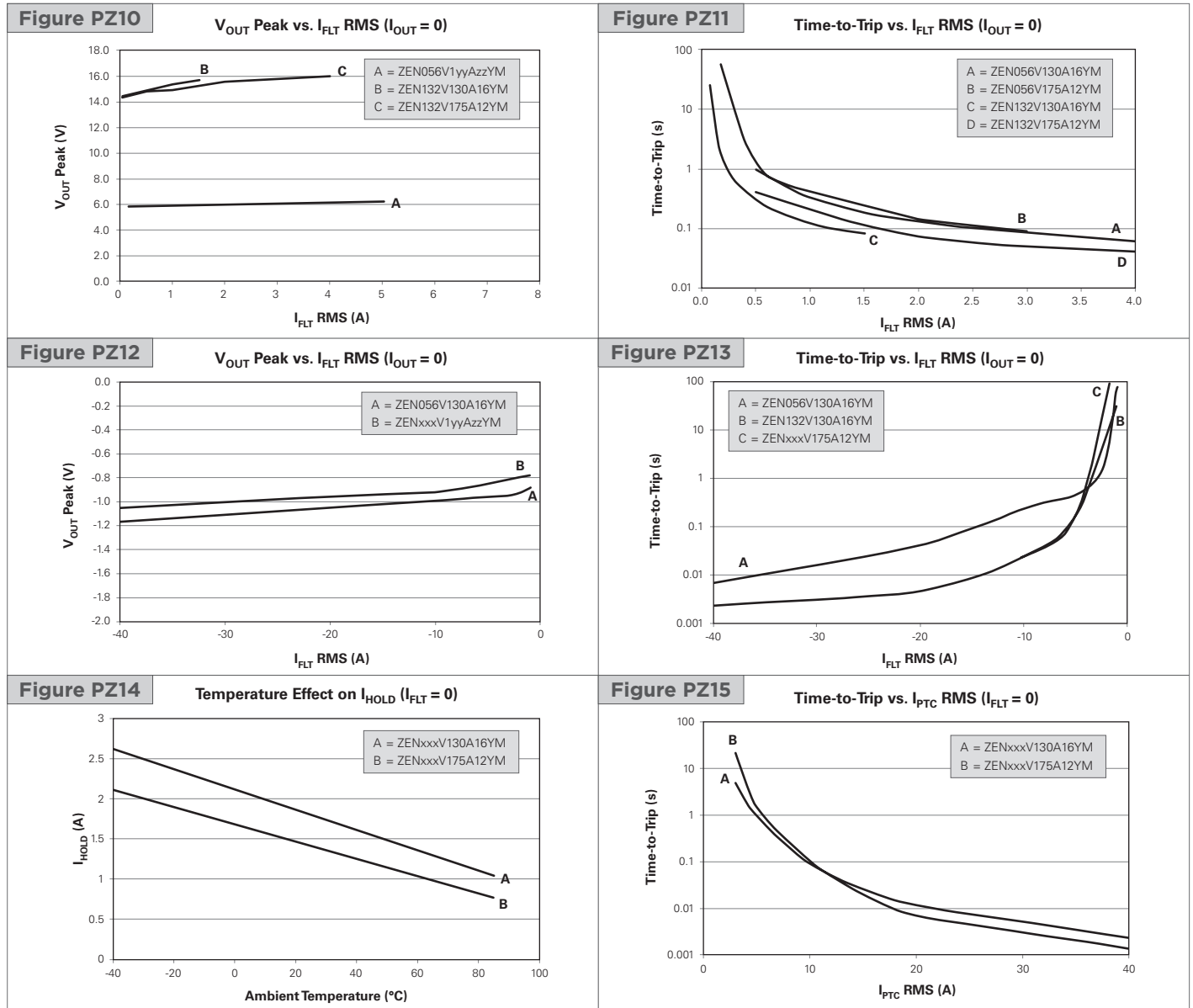

Figures PZ16-PZ21 – Typical Performance Curves for PolyZen Devices -YC Series

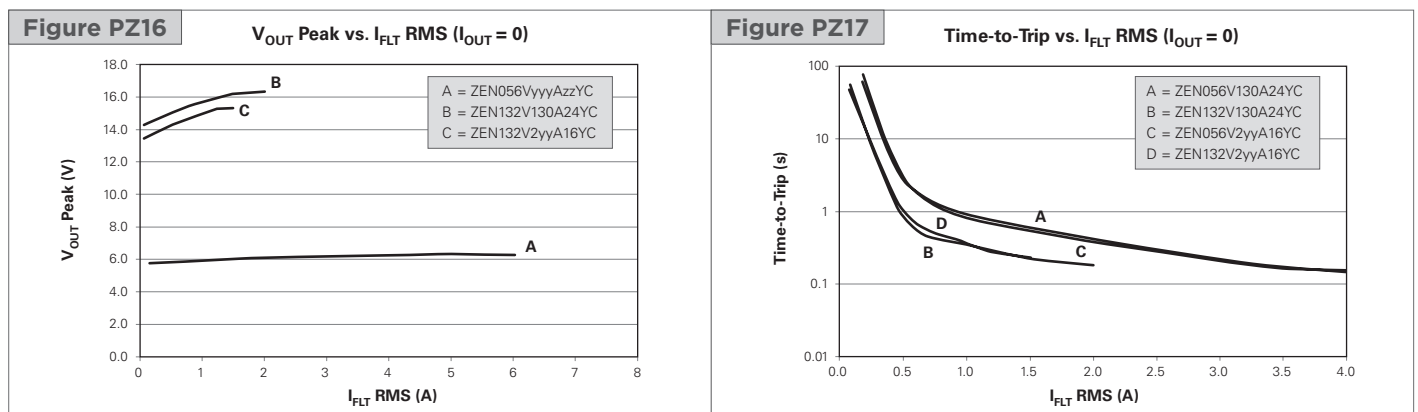

PolyZen Devices

Polymer Protected Zener Diode

Figures PZ16-PZ21 – Typical Performance Curves for PolyZen Devices -YC Series

(Cont'd)

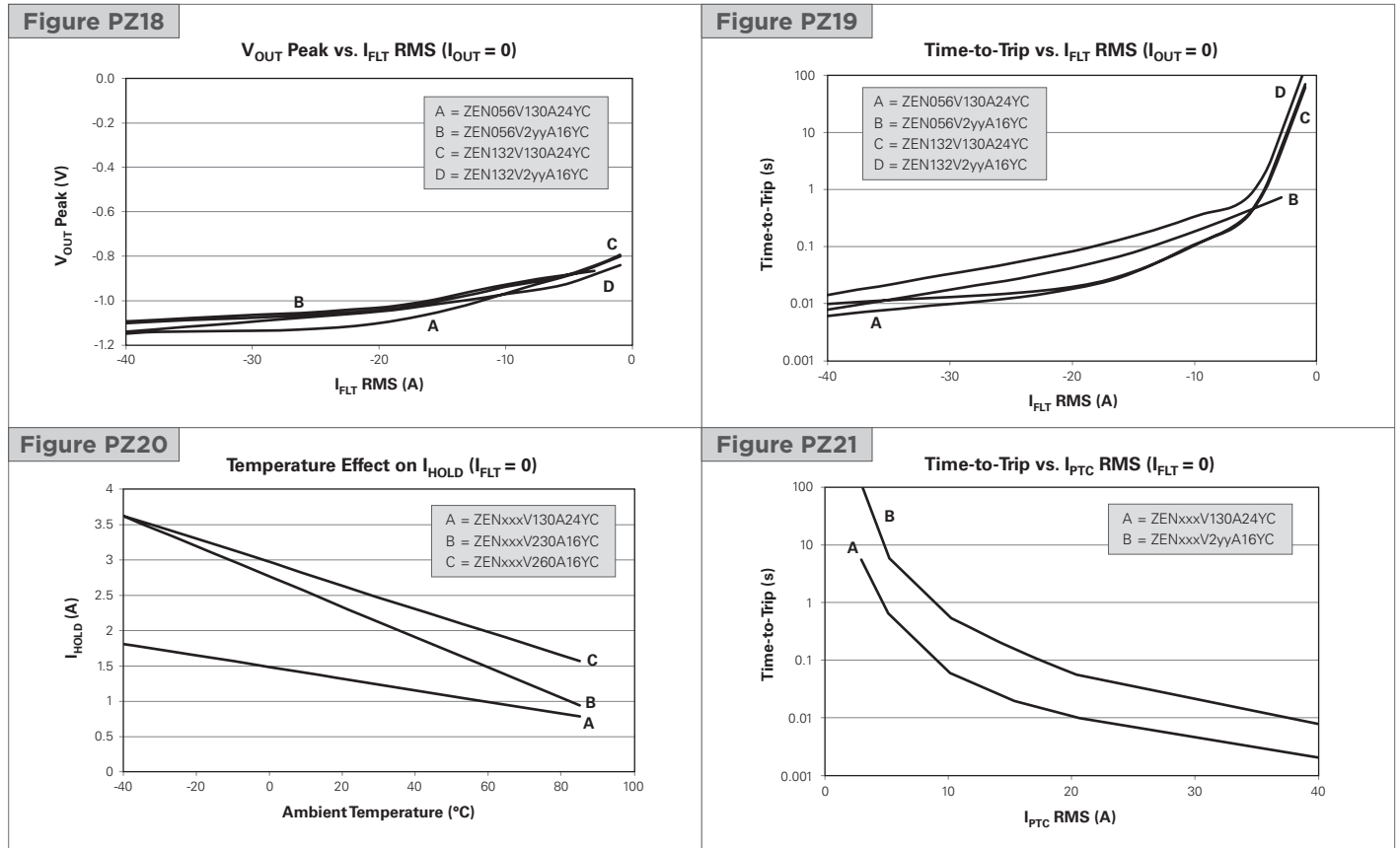

Table PZ3 – General Characteristics for PolyZen Devices

Operating temperature range	-40° to +85°C
Storage temperature	-40° to +85°C
ESD withstand	15kV
Diode capacitance	4200pF
Construction	RoHS compliant
	Human body model
	Typical @ 1MHz, 1V RMS

Figures PZ22-PZ34 – Basic Operation Examples for PolyZen Devices - LS Series

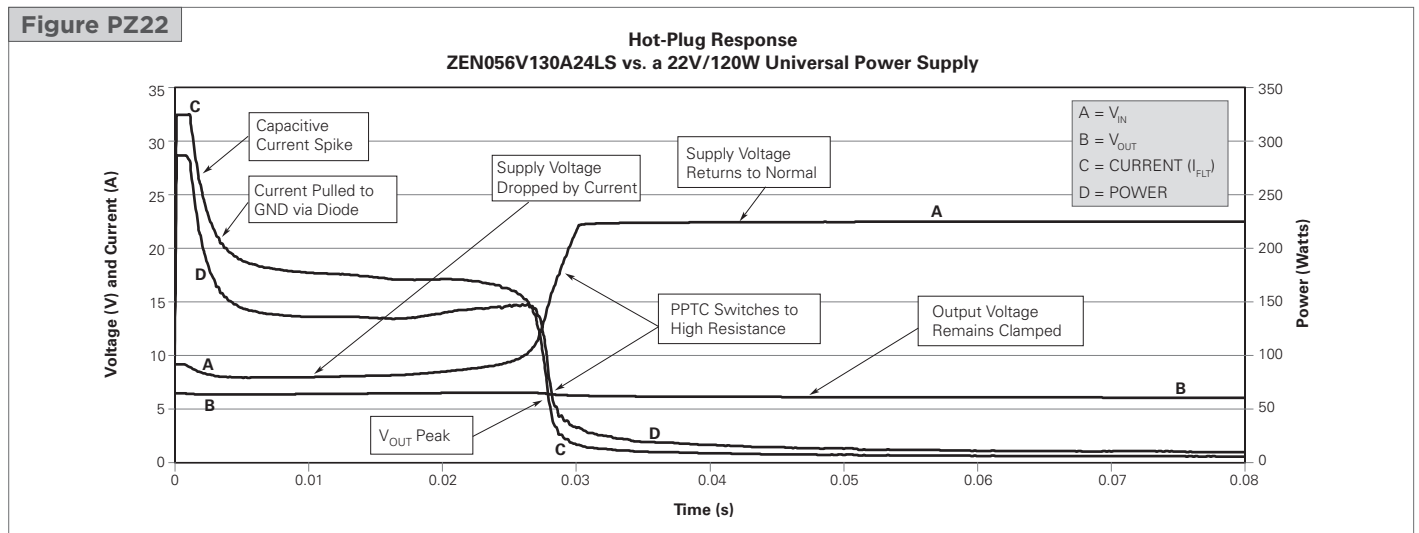

Figure PZ23

Typical Fault Response: ZEN056V1xxA24LS
 20V, 3.5A Current Limited Source ($I_{OUT}=0$)

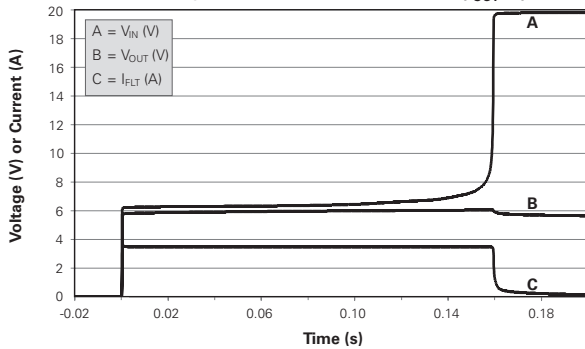

Figure PZ24

Typical Fault Response: ZEN059V130A24LS
 24V, 6A Current Limited Source ($I_{OUT}=0$)

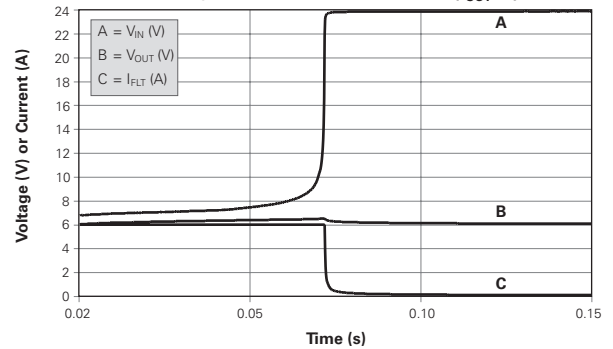

Figure PZ25

Typical Fault Response: ZEN065V130A24LS
 24V, 5.0A Current Limited Source ($I_{OUT}=0$)

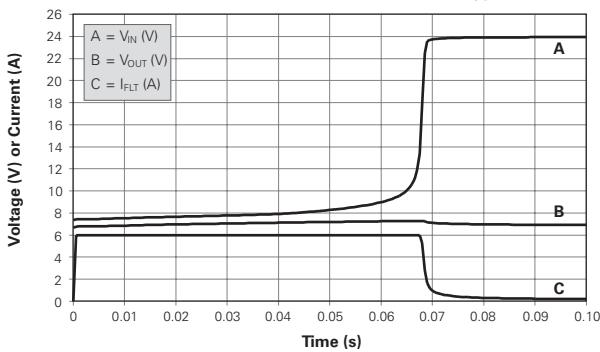

Figure PZ26

Typical Fault Response: ZEN098V130A24LS
 24V, 3.5A Current Limited Source ($I_{OUT}=0$)

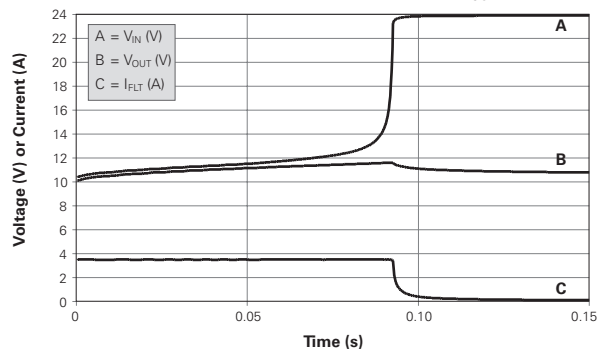

Figure PZ27

Typical Fault Response: ZEN132V130A24LS
 24V, 2.0A Current Limited Source ($I_{OUT}=0$)

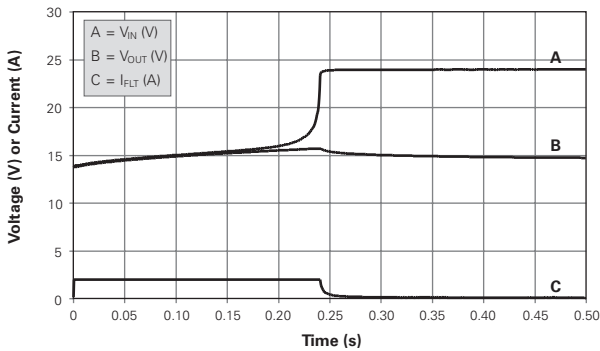

Figure PZ28

Typical Fault Response: ZEN164V130A24LS
 24V, 1.0A Current Limited Source ($I_{OUT}=0$)

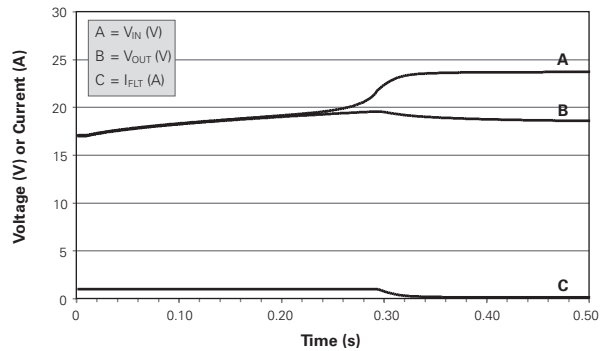

Figure PZ29

Typical Fault Response: ZEN056V230A16LS
 16V, 5.0A Current Limited Source ($I_{OUT}=0$)

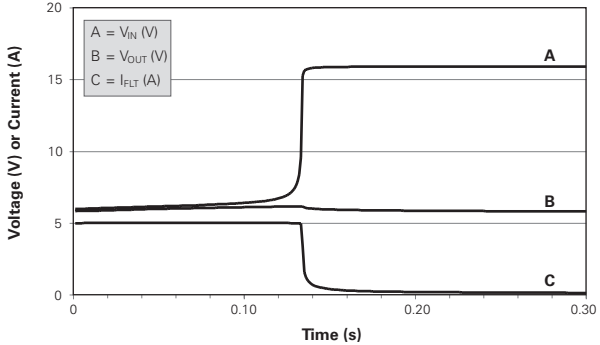
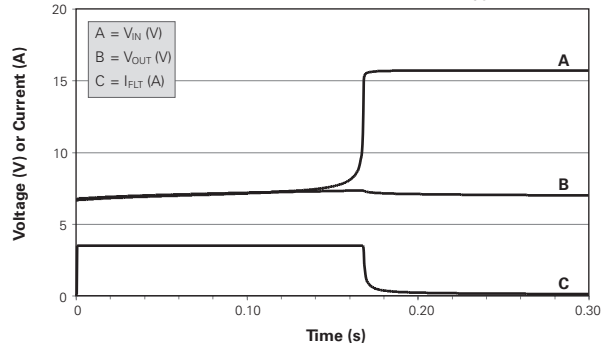

Figure PZ30

Typical Fault Response: ZEN065V230A16LS
 16V, 3.5A Current Limited Source ($I_{OUT}=0$)



PolyZen Devices

Polymer Protected Zener Diode

Figures PZ22-PZ34 – Basic Operation Examples for PolyZen Devices - LS Series

(Cont'd)

Figure PZ31 Typical Fault Response: ZEN098V230A16LS
16V, 3.5A Current Limited Source ($I_{OUT}=0$)

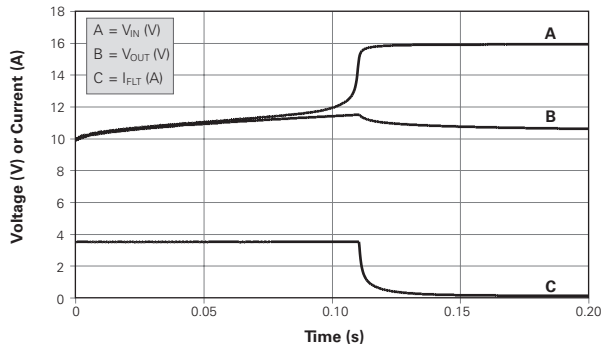

Figure PZ32 Typical Fault Response: ZEN132V230A16LS
20V, 2.0A Current Limited Source ($I_{OUT}=0$)

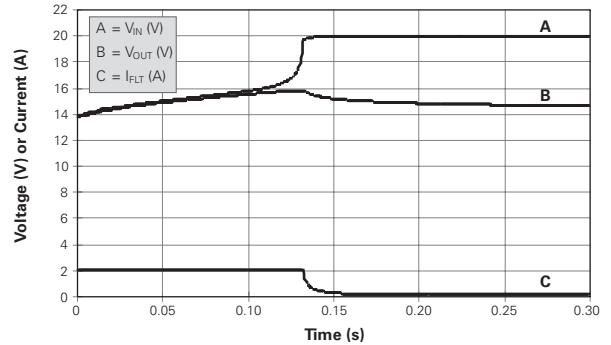

Figure PZ33 Typical Fault Response: ZEN056V075A48LS
48V, 10.0A Current Limited Source ($I_{OUT}=0$)

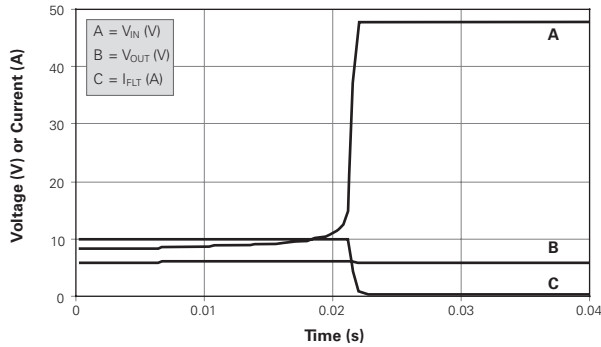

Figure PZ34 Typical Fault Response: ZEN132V075A48LS
48V, 2.0A Current Limited Source ($I_{OUT}=0$)

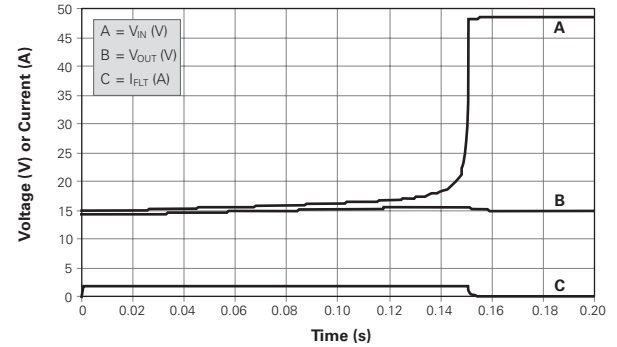

Figure PZ35 Typical Fault Response: ZEN056V130A16YM
20V/3A Current Limited Source ($I_{OUT} = 0$)

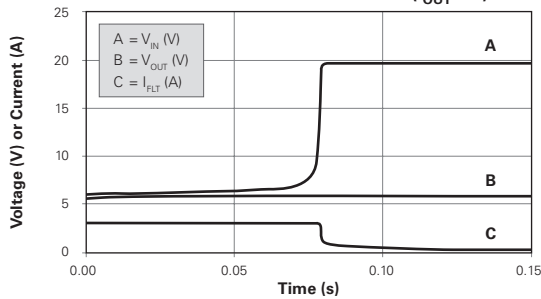

Figure PZ36 Typical Fault Response: ZEN056V175A12YM
12V/3A Current Limited Source ($I_{OUT} = 0$)

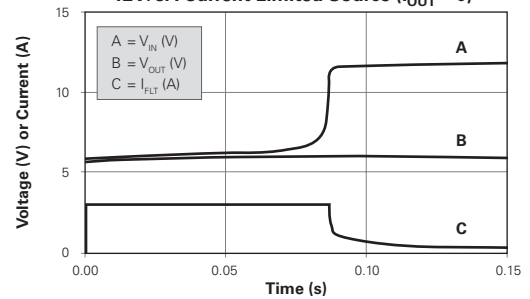

Figure PZ37 Typical Fault Response: ZEN132V130A16YM
20V/1A Current Limited Source ($I_{OUT} = 0$)

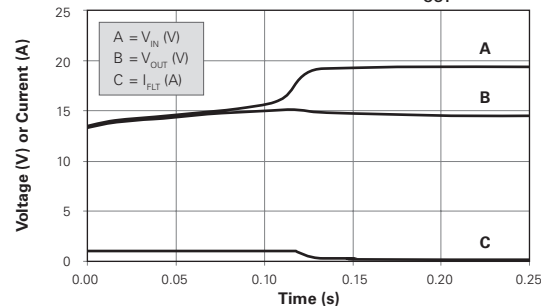
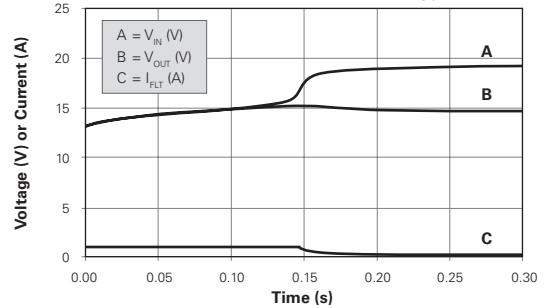

Figure PZ38 Typical Fault Response: ZEN132V175A12YM
20V/1A Current Limited Source ($I_{OUT} = 0$)



PolyZen Devices

Polymer Protected Zener Diode

Figures PZ39-PZ44 – Basic Operation Examples for PolyZen Devices -YC Series

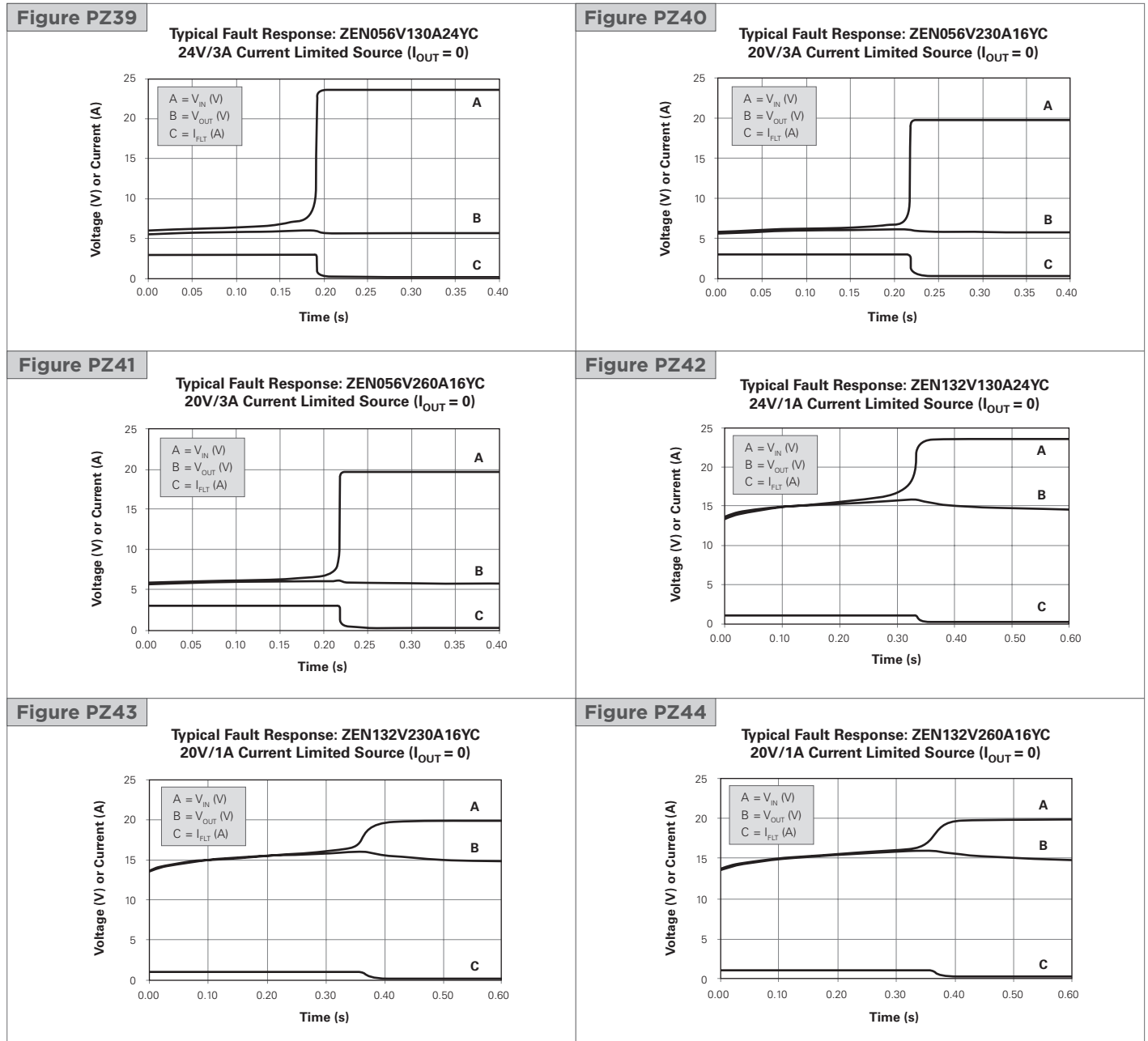

Table PZ4 - Packaging and Marking Information for PolyZen Devices

Part Number	Bag Quantity	Tape & Reel Quantity	Standard Package
ZENxxxVyyyAzzLS	—	3,000	15,000
ZENxxxVyyyAzzYM	—	3,000	30,000
ZENxxxVyyyAzzYC	—	4,000	20,000

PolyZen Devices

Polymer Protected Zener Diode

Table PZ5 – Dimensions in Millimeters and (Inches)

ZENxxxVyyyAzzLS Devices

	A		B		C	
	Min	Max	Min	Max	Min	Max
mm	3.85	4.15	3.85	4.15	1.40	2.00
in	(0.152)	(0.163)	(0.152)	(0.163)	(0.055)	(0.081)

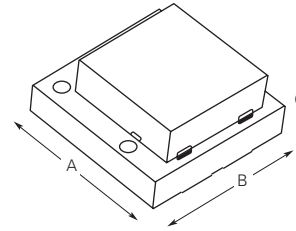

ZENxxxVyyyAzzYM Devices

	A		B		C	
	Min	Max	Min	Max	Min	Max
mm	3.00	3.40	2.30	2.70	1.10	1.30
in	(0.118)	(0.134)	(0.091)	(0.106)	(0.043)	(0.051)

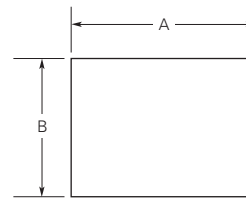
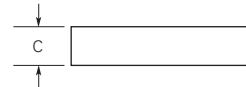

ZENxxxVyyyAzzYC Devices

	A		B		C	
	Min	Max	Min	Max	Min	Max
mm	4.80	5.20	3.80	4.20	1.20	1.40
in	(0.190)	(0.206)	(0.150)	(0.166)	(0.047)	(0.055)

ZENxxxVyyyAzzLS Devices

Pin Number	Pin Name	Pin Function
1	V_{IN}	V_{IN} = Protected input to Zener diode
2	GND	GND = Ground
3	V_{OUT}	V_{OUT} = Zener regulated voltage output

Pin Configuration (Top View)

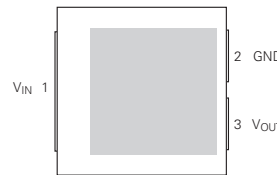

Pad Dimensions

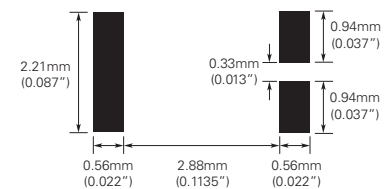

ZENxxxVyyyAzzYM Devices

Pin Number	Pin Name	Pin Function
1	V_{IN}	V_{IN} = Protected input to Zener diode
2	GND	GND = Ground
3	V_{OUT}	V_{OUT} = Zener regulated voltage output

Pin Configuration (Top View)

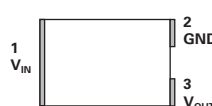

Recommended Pad Dimensions (mm)

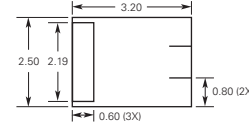

Recommended Pad Layout (mm)

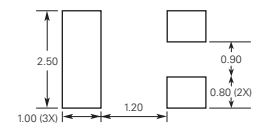

ZENxxxVyyyAzzYC Devices

Pin Number	Pin Name	Pin Function
1	V_{IN}	V_{IN} = Protected input to Zener diode
2	GND	GND = Ground
3	V_{OUT}	V_{OUT} = Zener regulated voltage output

Pin Configuration (Top View)

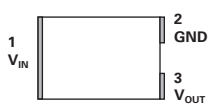

Recommended Pad Dimensions (mm)

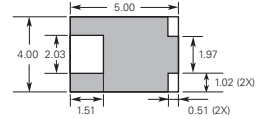

Recommended Pad Layout (mm)

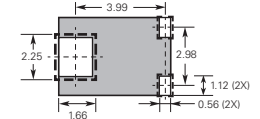

PolyZen Devices

Polymer Protected Zener Diode

Solder Reflow and Rework Recommendation

Classification Reflow Profiles

Profile Feature	ZENxxxVyyyAzzLS Devices	ZENxxxVyyyAzzYM Devices	ZENxxxVyyyAzzYC Devices
	Pb-Free Assembly		Pb-Free Assembly
Average Ramp Up Rate (Ts_{MAX} to Tp)	3°C/ s Max		3°C/ s Max
Preheat			
• Temperature Min (Ts _{MIN})	150°C		150°C
• Temperature Max (Ts _{MAX})	200°C		200°C
• Time (ts Preheat)	60-180 s		60-180 s
Time Maintained Above:			
• Temperature (T _L)	217°C		217°C
• Time (t _L)	60-150 s		60-150 s
Peak/Classification Temperature (Tp)	260°C		250°C
Time within 5°C of Actual Peak Temperature			
Time (tp)	20-40 s		20-40 s
Average Ramp Down Rate (Tp to T_L)	6°C/ s Max		3°C/ s Max
Time 25°C to Peak Temperature	8 Minutes Max		8 Minutes Max

Note: All temperatures refer to top side of the package, measured on the package

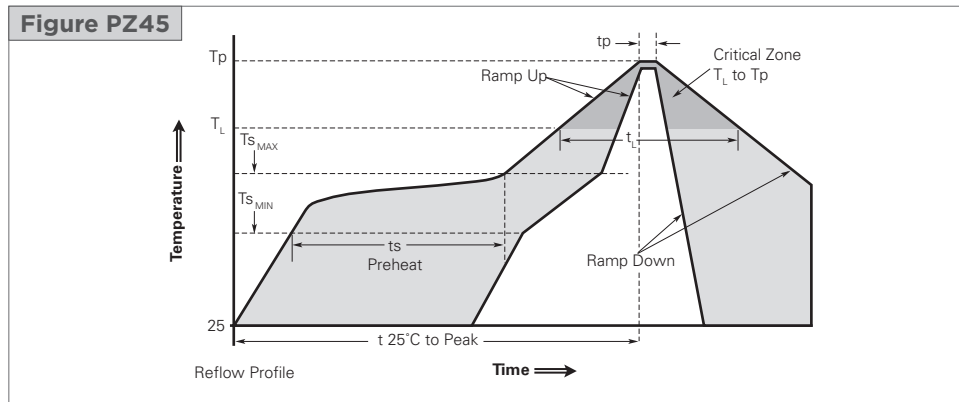

Tape and Reel Specifications for PolyZen Devices in Millimeters

Figure PZ46 — EIA Referenced Taped Component Dimensions for ZENxxxVyyyAzzLS Devices in Millimeters (mm)

Description	ZENxxxVyyyAzzLS Devices
A ₀	4.35
B ₀	4.35
K ₀	2.30

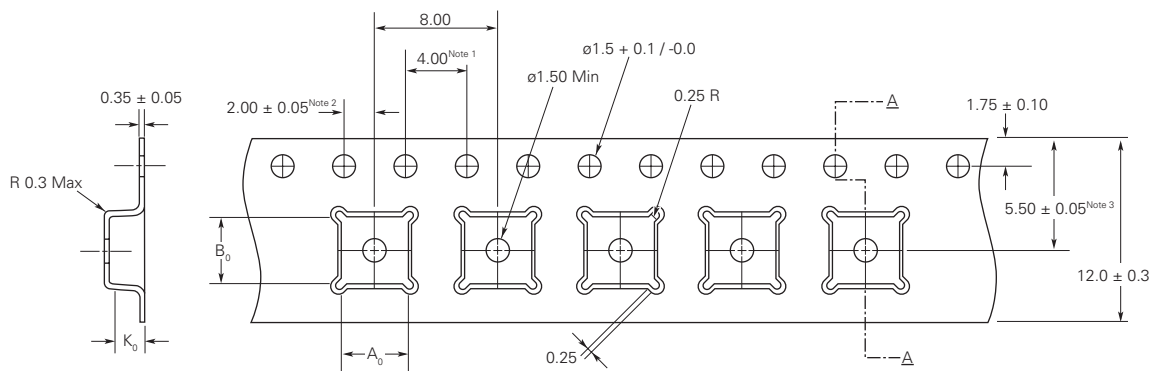

Notes: 1. 10 sprocket hole pitch cumulative tolerance ± 0.2
 2. Camber in compliance with EIA 481

PolyZen Devices

Polymer Protected Zener Diode

Figure PZ47 – Reel Dimensions for ZENxxxVyyyAzzLS Devices in Millimeters (mm)

Description	Dimension (mm)
A_{Max}	330
N_{Min}	102
W_1	8.4
W_2	11.1

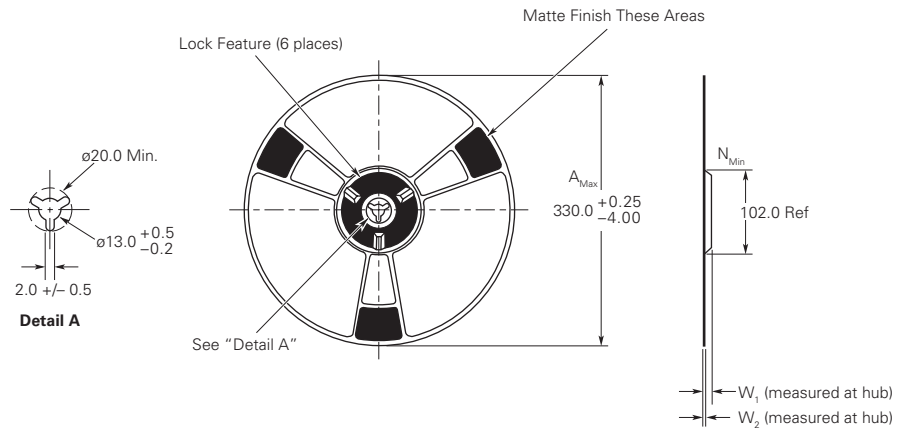

SYMBOL	A_0	B_0	K_0	P_0	P_1	P_2	B_{1Max}
SPEC	2.90 ± 0.10	3.55 ± 0.10	1.27 ± 0.10	4.00 ± 0.10	4.00 ± 0.10	2.00 ± 0.05	4.35
SYMBOL	T	E1	F	D_0	D_1	W	D_{1Max}
SPEC	0.25 ± 0.02	1.75 ± 0.10	3.50 ± 0.05	1.55 ± 0.05	1.00 ± 0.10	8.00 ± 0.30	1.0

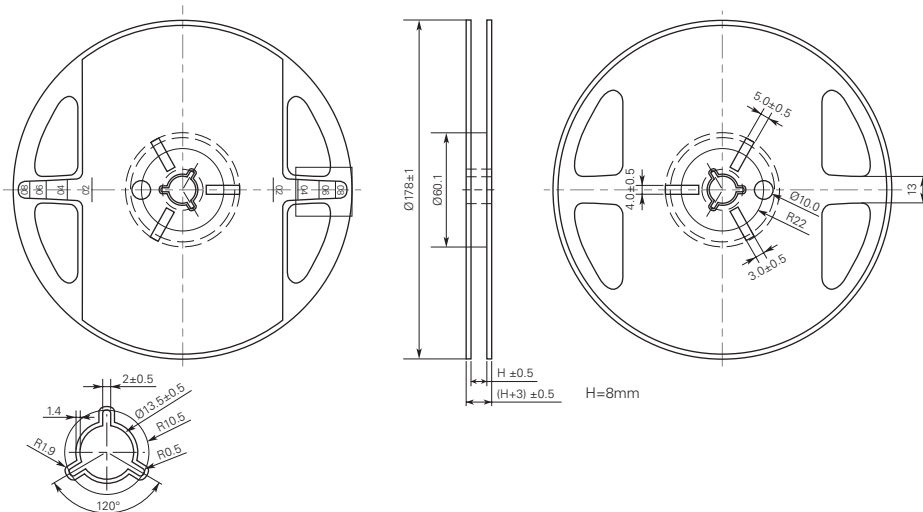
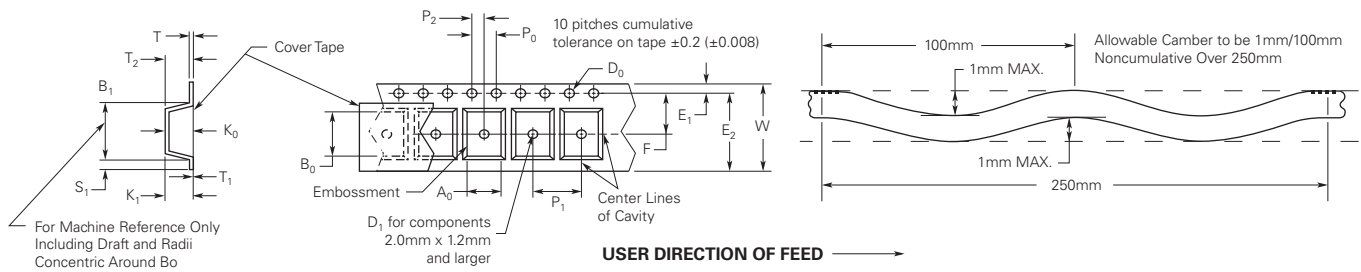

PolyZen Devices

Polymer Protected Zener Diode

Figure PZ50 – EIA Referenced Taped Component Dimensions for ZENxxxVyyyAzzYC Devices in Millimeters (mm)

Item	Dimension	Tolerance
W	12.00	±0.10
P	8.00	±0.10
E	1.75	±0.10
F	5.50	±0.10
P ₂	2.00	±0.10
D	1.50	+0.10 -0.00
D ₁	1.50	±0.10
P ₀	4.00	±0.10
10P ₀	40.00	±0.20
A ₀	4.20	±0.10
B ₀	5.25	±0.10
K ₀	1.40	±0.10
t	0.24	±0.05

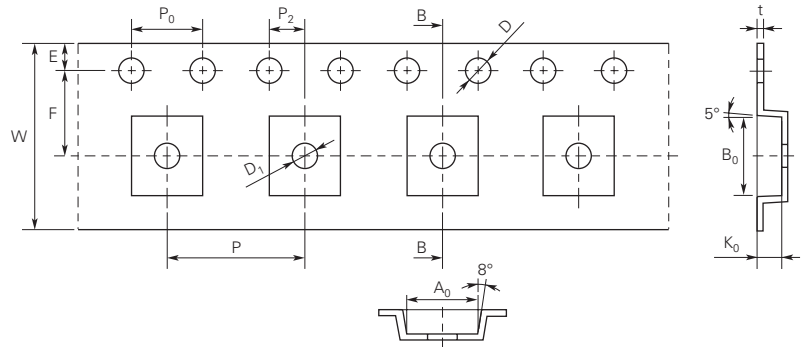
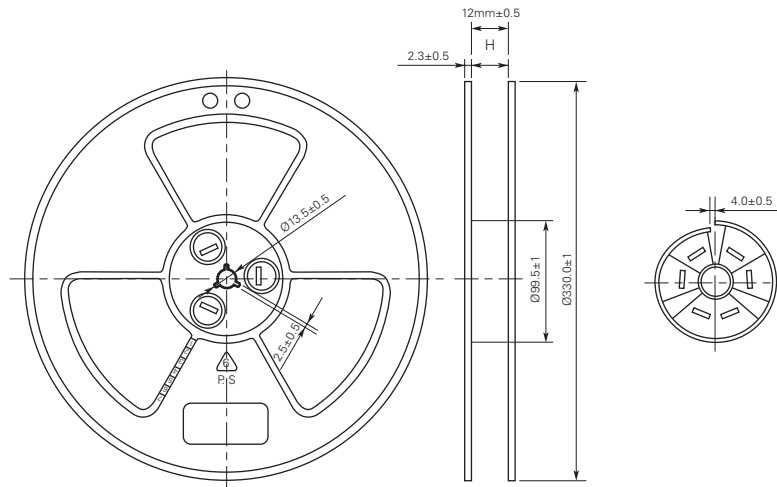
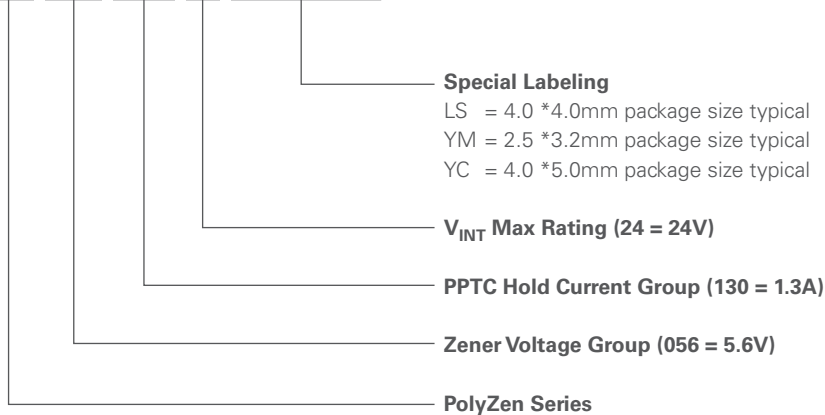

Figure PZ51 – Reel Dimensions for ZENxxxVyyyAzzYC Devices in Millimeters (mm)



Part Numbering System

ZEN 056V 130A 24 LS & YC & YM



PolyZen Devices

Polymer Protected Zener Diode

Part Marking System

ZENxxxVyyyAzzLS Devices

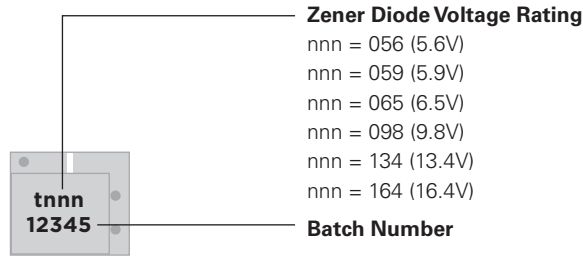

ZENxxxVyyyAzzYM Devices

Markings	V _z	Hold Current	Special Code	Part Description
0513F	5.6V	1.3A	F	ZEN056V130A16YM
0517F	5.6V	1.75A	F	ZEN056V175A12YM
1313F	13.2V	1.3A	F	ZEN132V130A16YM
1317F	13.2V	1.75A	F	ZEN132V175A12YM

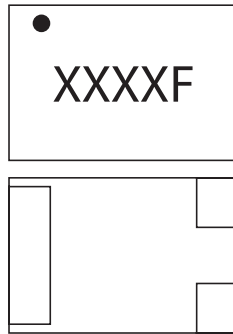

ZENxxxVyyyAzzYC Devices

Markings	V _z	Hold Current	Special Code	Part Description
0513F	5.6V	1.3A	F	ZEN056V130A24YC
052XF	5.6V	2.3A	F	ZEN056V230A16YC
052XF	5.6V	2.6A	F	ZEN056V230A16YC
1313F	13.2V	1.3A	F	ZEN132V130A24YC
132XF	13.2V	2.3A	F	ZEN132V230A16YC
132XF	13.2V	2.6A	F	ZEN132V230A16YC
####				Last 4 digits of batch number

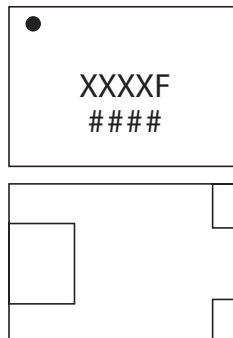

PolyZen Devices

Polymer Protected Zener Diode

Notice:

Littelfuse products are not designed for, and shall not be used for, any purpose (including, without limitation, automotive, military, aerospace, medical, life-saving, life-sustaining or nuclear facility applications, devices intended for surgical implant into the body, or any other application in which the failure or lack of desired operation of the product may result in personal injury, death, or property damage) other than those expressly set forth in applicable Littelfuse product documentation. Warranties granted by Littelfuse shall be deemed void for products used for any purpose not expressly set forth in applicable Littelfuse documentation. Littelfuse shall not be liable for any claims or damages arising out of products used in applications not expressly intended by Littelfuse as set forth in applicable Littelfuse documentation. The sale and use of Littelfuse products is subject to Littelfuse Terms and Conditions of Sale, unless otherwise agreed by Littelfuse.

Looking for pricing, stock, or lifecycle information?

Click below to explore more details on WIN SOURCE:

 [View ZEN098V230A16LS on WIN SOURCE](#)

 [Littelfuse Inc. Information](#)

Optimize Your Supply Chain with WIN SOURCE Solutions

-  Global Sourcing Solution
-  Obsolete Management
-  Cost Control Management
-  Shortage Management
-  Alternative Solution
-  Excess Inventory Management