

E-Series RF 1:1 Transmission Line Transformer 4.5 - 3000 MHz

Rev. V5

Features

- Surface mount
- Wide frequency range
- 1:1 impedance
- Lead Free
- RoHS* Compliant
- 260°C reflow compatible
- Available on Tape and Reel

Description

The MABA-007159 is a RoHS compliant 1:1 RF transmission line transformer in a low cost, surface mount package. The windings of the MABA-007159 are welded to the package substrate for improved reliability and to eliminate lead content. Ideally suited for high volume cellular and wireless application. Parts are packaged in tape & reel.

Schematic

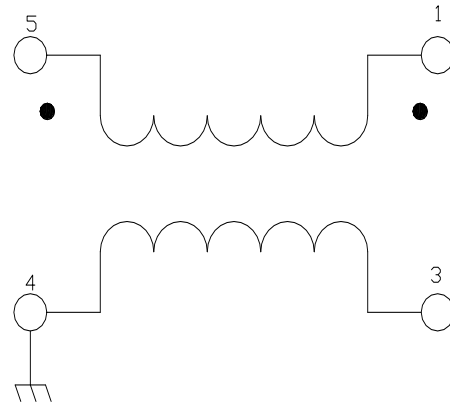

Pin Configuration

Pin No.	Function
1	Secondary Dot
2	Not Connected
3	Secondary
4	Primary
5	Primary Dot

Electrical Specifications: RF Freq. = 4.5 - 3000 MHz, $T_A = 25^\circ\text{C}$, $Z_0 = 50 \Omega$

Parameter	Test Frequency	Units	Min.	Typ.	Max.
Insertion Loss	4.5 - 1000	dB	—	0.32	1.0
	1000 - 2000			—	2.0
	2000 - 3000			—	3.5
Amplitude Unbalance	4.5 - 1000	dB	—	—	1.0
Phase Unbalance	4.5 - 1000	Degrees	—	—	20

Ordering Information

Part Number	Package
MABA-007159-000000	2000 piece reel

Recommended Maximum Ratings^{1,2}

Parameter	Absolute Maximum
DC Power	250 mW
DC Current	30 mA
Operating Temperature	-55°C to +85°C
Storage Temperature	-55°C to +125°C

1. Exceeding any one or combination of these limits may cause permanent damage to this device.
2. MACOM does not recommend sustained operation near these survivability limits.

Typical Performance Curves

Insertion Loss

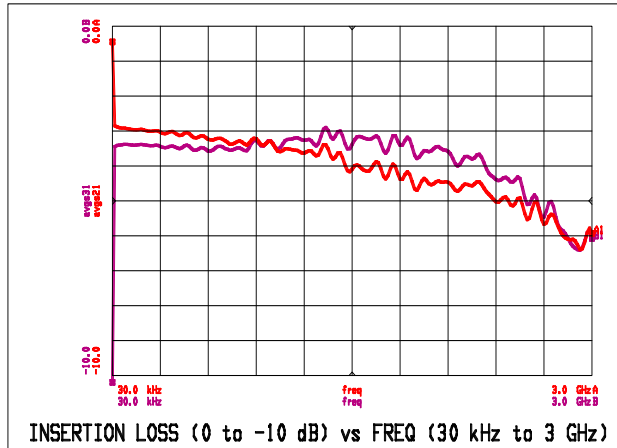

Input Impedance

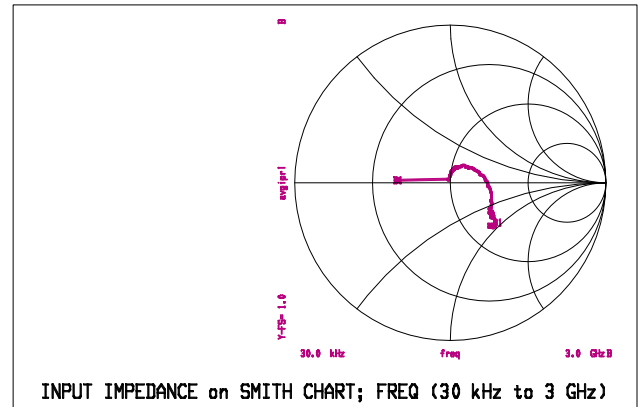

Phase Unbalance

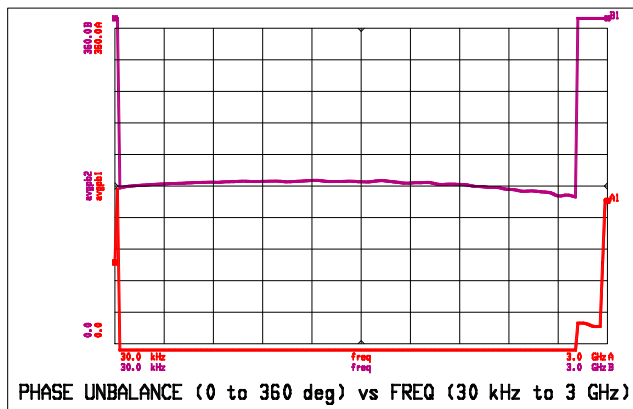

Amplitude Unbalance

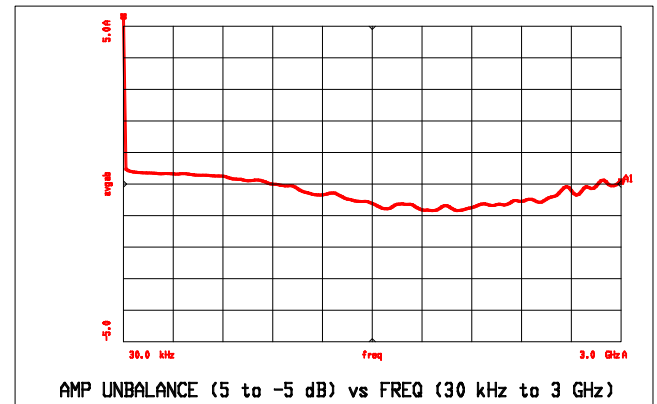

Outline Drawing

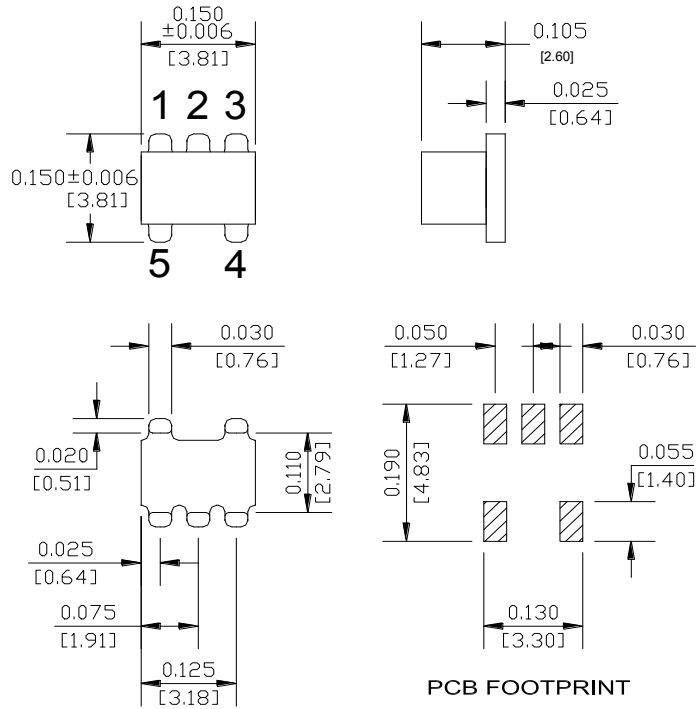

* Dimensions are inches (millimeters) ± 0.015 (0.38) unless otherwise specified.

Tape & Reel Information

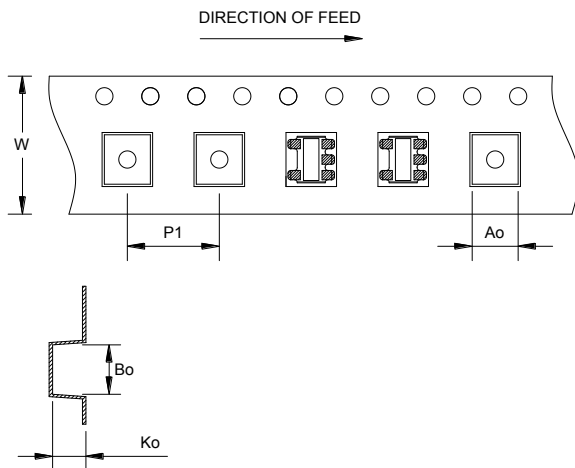

Tape & Reel Information

Item	Dimension (mm)
Ao	4.00 +/-0.1
Bo	4.30 +/-0.1
Ko	2.90 +/-0.1
W	12.00 +/-0.3
P1	8.00 +/-0.1

MACOM Technology Solutions Inc. All rights reserved.

Information in this document is provided in connection with MACOM Technology Solutions Inc ("MACOM") products. These materials are provided by MACOM as a service to its customers and may be used for informational purposes only. Except as provided in MACOM's Terms and Conditions of Sale for such products or in any separate agreement related to this document, MACOM assumes no liability whatsoever. MACOM assumes no responsibility for errors or omissions in these materials. MACOM may make changes to specifications and product descriptions at any time, without notice. MACOM makes no commitment to update the information and shall have no responsibility whatsoever for conflicts or incompatibilities arising from future changes to its specifications and product descriptions. No license, express or implied, by estoppel or otherwise, to any intellectual property rights is granted by this document.

THESE MATERIALS ARE PROVIDED "AS IS" WITHOUT WARRANTY OF ANY KIND, EITHER EXPRESS OR IMPLIED, RELATING TO SALE AND/OR USE OF MACOM PRODUCTS INCLUDING LIABILITY OR WARRANTIES RELATING TO FITNESS FOR A PARTICULAR PURPOSE, CONSEQUENTIAL OR INCIDENTAL DAMAGES, MERCHANTABILITY, OR INFRINGEMENT OF ANY PATENT, COPYRIGHT OR OTHER INTELLECTUAL PROPERTY RIGHT. MACOM FURTHER DOES NOT WARRANT THE ACCURACY OR COMPLETENESS OF THE INFORMATION, TEXT, GRAPHICS OR OTHER ITEMS CONTAINED WITHIN THESE MATERIALS. MACOM SHALL NOT BE LIABLE FOR ANY SPECIAL, INDIRECT, INCIDENTAL, OR CONSEQUENTIAL DAMAGES, INCLUDING WITHOUT LIMITATION, LOST REVENUES OR LOST PROFITS, WHICH MAY RESULT FROM THE USE OF THESE MATERIALS.

MACOM products are not intended for use in medical, lifesaving or life sustaining applications. MACOM customers using or selling MACOM products for use in such applications do so at their own risk and agree to fully indemnify MACOM for any damages resulting from such improper use or sale.

Looking for pricing, stock, or lifecycle information?

Click below to explore more details on WIN SOURCE:

- ⊖ [View MABA-007159-000000 on WIN SOURCE](#)
- ⊖ [M/A-Com Technology Solutions Information](#)

Optimize Your Supply Chain with WIN SOURCE Solutions

- ✓ Global Sourcing Solution
- ✓ Obsolete Management
- ✓ Cost Control Management
- ✓ Shortage Management
- ✓ Alternative Solution
- ✓ Excess Inventory Management