



THE DATASHEET OF FAN7387MX





Is Now Part of



ON Semiconductor®

To learn more about ON Semiconductor, please visit our website at www.onsemi.com

Please note. As part of the Fairchild Semiconductor integration, some of the Fairchild orderable part numbers will need to change in order to meet ON Semiconductor's system requirements. Since the ON Semiconductor product management systems do not have the ability to manage part nomenclature that utilizes an underscore (_), the underscore (_) in the Fairchild part numbers will be changed to a dash (-). This document may contain device numbers with an underscore (_). Please check the ON Semiconductor website to verify the updated device numbers. The most current and up-to-date ordering information can be found at www.onsemi.com. Please email any questions regarding the system integration to Fairchild_questions@onsemi.com.

ON Semiconductor and the ON Semiconductor logo are trademarks of Semiconductor Components Industries, LLC dba ON Semiconductor or its subsidiaries in the United States and/or other countries. ON Semiconductor owns the rights to a number of patents, trademarks, copyrights, trade secrets, and other intellectual property. A listing of ON Semiconductor's product/patent coverage may be accessed at www.onsemi.com/site/pdf/Patent-Marking.pdf. ON Semiconductor reserves the right to make changes without further notice to any products herein. ON Semiconductor makes no warranty, representation or guarantee regarding the suitability of its products for any particular purpose, nor does ON Semiconductor assume any liability arising out of the application or use of any product or circuit, and specifically disclaims any and all liability, including without limitation special, consequential or incidental damages. Buyer is responsible for its products and applications using ON Semiconductor products, including compliance with all laws, regulations and safety requirements or standards, regardless of any support or applications information provided by ON Semiconductor. "Typical" parameters which may be provided in ON Semiconductor data sheets and/or specifications can and do vary in different applications and actual performance may vary over time. All operating parameters, including "Typicals" must be validated for each customer application by customer's technical experts. ON Semiconductor does not convey any license under its patent rights nor the rights of others. ON Semiconductor products are not designed, intended, or authorized for use as a critical component in life support systems or any FDA Class 3 medical devices or medical devices with a same or similar classification in a foreign jurisdiction or any devices intended for implantation in the human body. Should Buyer purchase or use ON Semiconductor products for any such unintended or unauthorized application, Buyer shall indemnify and hold ON Semiconductor and its officers, employees, subsidiaries, affiliates, and distributors harmless against all claims, costs, damages, and expenses, and reasonable attorney fees arising out of, directly or indirectly, any claim of personal injury or death associated with such unintended or unauthorized use, even if such claim alleges that ON Semiconductor was negligent regarding the design or manufacture of the part. ON Semiconductor is an Equal Opportunity/Affirmative Action Employer. This literature is subject to all applicable copyright laws and is not for resale in any manner.



May 2024

FAN7387 Self-Oscillated, High-Voltage Gate Driver

Features

- Internal Clock Using RCT
- External Sync Function Using RCT
- Dead Time Control Using Resistor
- Shut Down (Disable Mode)
- Internal Shunt Regulator
- UVLO Function, High and Low Side

Description

The FAN7387 is a complete control IC for common half-bridge inverter, SMPS and ballast for fluorescent and HID lamps. The FAN7387 has an oscillating circuit using an external resistor and capacitor.

The frequency variation is very stable across a wide temperature range. The FAN7387 has an external pin for dead-time control and shutdown. Using this resistor, the designer can choose the optimum dead time to reduce power loss on switching devices, such as transistors and MOSFETs.

Applications

- Half-Bridge Inverter
- SMPS
- Ballast Solution for High-Intensity Discharge (HID) Lamp
- Ballast for Fluorescent Lamp

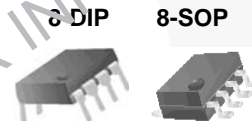

Ordering Information

Part Number	Package	Operating Temperature	Packing Method
FAN7387MX ⁽¹⁾	8-SOP	-40 to +125°C	Tape & Reel

Note:

1. These device passed wave soldering test by JESD22A-111.

Typical Application Diagrams (Continued)

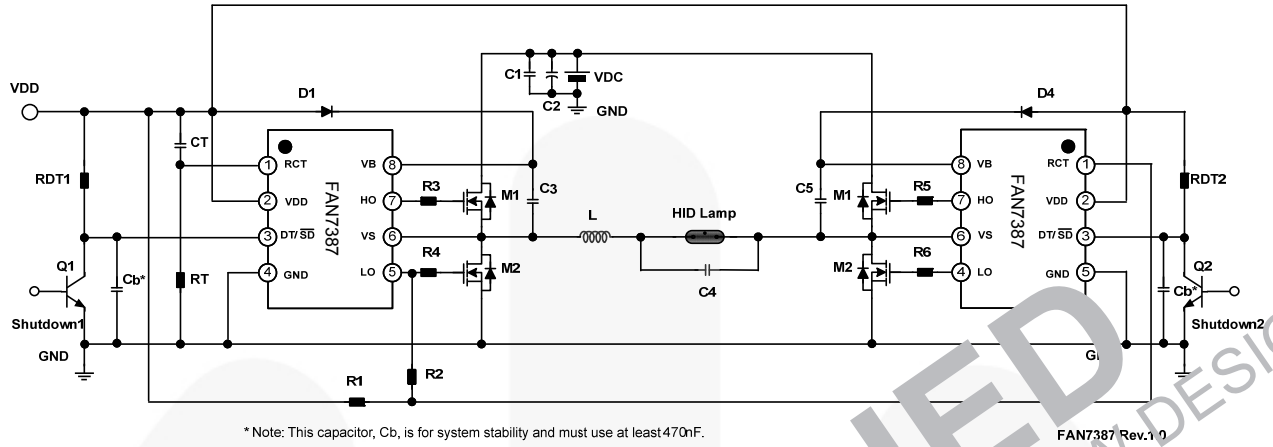

Figure 3. Typical Application Circuit for Full-Bridge Converter

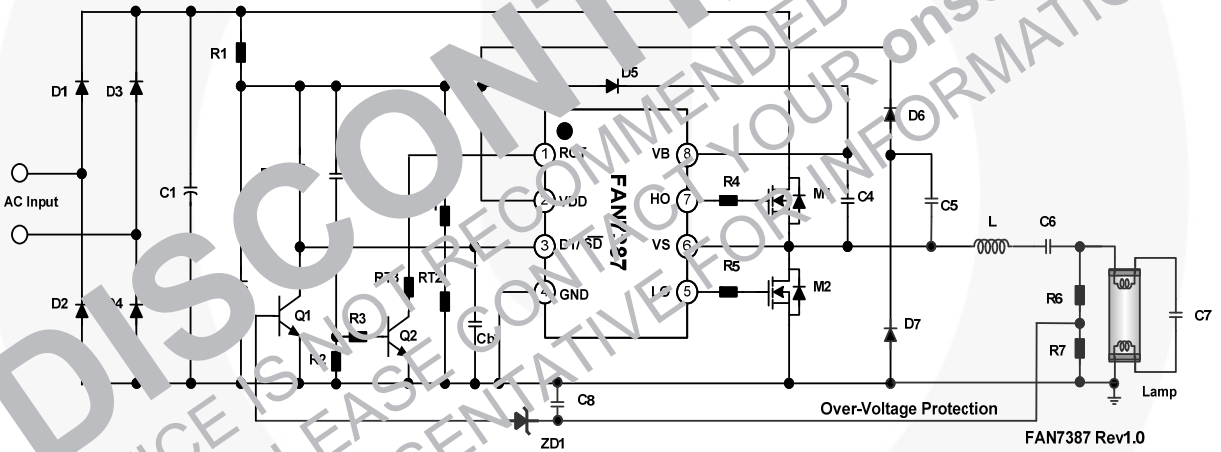

Figure 4. Typical Application Circuit for Fluorescent Lamp Ballast

Internal Block Diagram

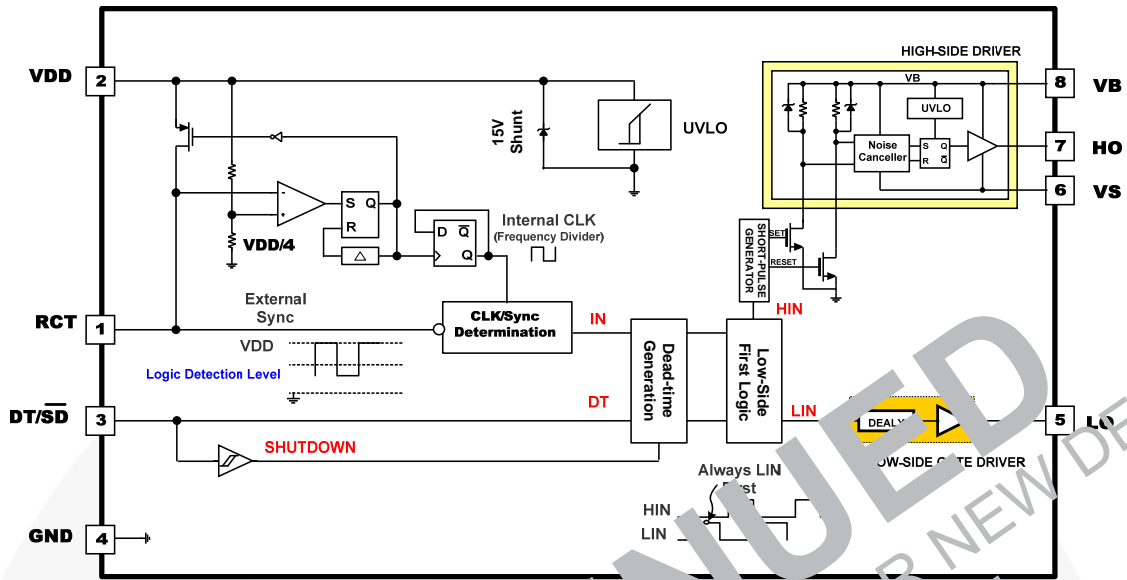

Figure 5. Functional Block Diagram

Pin Configuration

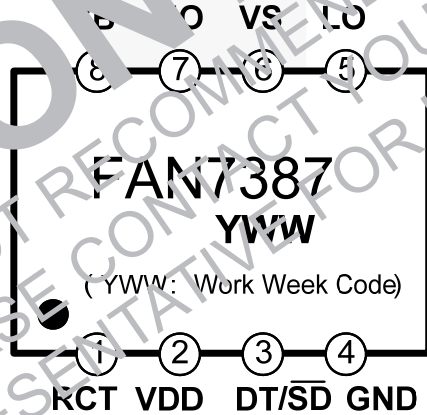

Figure 6. Pin Configurations (Top View)

Pin Definitions

Pin #	Name	Description
1	RCT	Oscillator frequency set resistor and capacitor.
2	VDD	Supply Voltage.
3	DT/SD	Dead-time control and shutdown (active LOW).
4	GND	Signal Ground.
5	LO	Low-Side Output.
6	VS	High-Side floating supply return.
7	HO	High-Side output.
8	VB	High-Side floating supply.

Absolute Maximum Ratings

Stresses exceeding the absolute maximum ratings may damage the device. The device may not function or be operable above the recommended operating conditions and stressing the parts to these levels is not recommended. In addition, extended exposure to stresses above the recommended operating conditions may affect device reliability. The absolute maximum ratings are stress ratings only. $T_A=25^{\circ}\text{C}$ unless otherwise specified.

Symbol	Parameter	Min.	Typ.	Max.	Unit
V_B	High-Side Floating Supply Voltage	-0.3		625.0	V
V_S	High-Side Offset Voltage	-0.3		600.0	V
V_{RCT}	RCT Pins Input Voltage			V_{CL}	V
I_{CL}	Clamping current level ⁽²⁾			25	mA
dV_S/dt	Allowable Offset Voltage Slew Rate		50		V/ns
T_A	Operating Temperature Range	-40		+125	$^{\circ}\text{C}$
T_{STG}	Storage Temperature Range	-65		+150	$^{\circ}\text{C}$
P_D	Power Dissipation		0.625		W
Θ_{JA}	Thermal Resistance (Junction-to-Air)		50		$^{\circ}\text{C/W}$

Note:

- Do not supply a low-impedance voltage source to the internal timing zero node between the GND and the VDD pin of this device.

Recommended Operating Ratings

The Recommended Operating Conditions table defines the conditions for actual device operation. Recommended operating conditions are specified to ensure optimal performance to the datasheet specifications. Fairchild does not recommend exceeding them or designing to absolute maximum ratings.

Symbol	Parameter	Min.	Max.	Unit.
V_B	High-Side Floating Supply Voltage	V_S+11	V_S+14	V
V_S	High-Side Offset Voltage	$6-V_{DD}$	600	V
V_L	Low-Side Supply Voltage	11	14	V
V_{HO}	High-Side (HO) Output Voltage	GND	V_{DD}	V
V_{LO}	Low-Side (LO) Output Voltage	GND	V_{DD}	V
V_{IH}	Logic "1" Input Voltage of RCT	$(3/4 V_{DD})+1$		V
V_{IL}	Logic "0" Input Voltage of RCT		$(3/5 V_{DD})-1$	V
R_T	Timing Resistor Value of RCT	2		k Ω
C_T	Timing Capacitor Value of RCT	100		pF
T_A	Ambient Temperature	-40	+125	$^{\circ}\text{C}$

Electrical Characteristics

V_{BIAS} (V_{DD} , $V_B - V_S$)=14.0 V, C_L =1 nF, R_T =50 k Ω and C_T =330 pF and T_A =25°C, unless otherwise specified.

Symbol	Parameter	Conditions	Min.	Typ.	Max.	Unit
Low-Side Supply Characteristics (V_{DD})						
V_{DDUV+}	V_{DD} Supply Under-Voltage Positive-Going Threshold	V_{DD} Increasing	9.50	11.00	12.50	V
V_{DDUV-}	V_{DD} Supply Under-Voltage Negative-Going Threshold	V_{DD} Decreasing	7.5	9.0	10.5	V
V_{DDUVH}	V_{DD} Supply Under-Voltage Lockout Hysteresis			2		V
V_{CL}	Supply Camping Voltage	I_{DD} =10 mA	14.8	15.4		V
I_{QDD}	Low-Side Quiescent Supply Current	R_{DT} =100 k Ω		200	500	μ A
I_{ST}	Startup Supply Current	V_{DD} =9 V		50	130	μ A
I_{LK}	Offset Supply Leakage Current	$V_B=V_S=600$ V			10	μ A
I_{PDD}	Low-Side Dynamic Operating Supply Current			0.8		mA
High-Side Supply Characteristics (V_B-V_S)						
V_{BSUV+}	V_{BS} Supply Under-Voltage Negative-Going Threshold	V_B-V_S Increasing	7.7	9.2	10.7	V
V_{BSUV-}	V_{BS} Supply Under-Voltage Negative-Going Threshold	V_B-V_S Decreasing	7.1	8.6	10.1	V
V_{BSUVH}	V_{BS} Supply Under-Voltage Lockout Hysteresis			0.6		V
I_{QBS}	High-Side Quiescent Supply Current			50	130	μ A
I_{PBS}	High-Side Dynamic Operating Supply Current			400	800	μ A
Oscillator Characteristics						
f_{osc1}	Oscillation Frequency 1	$R_T=50$ k Ω , $C_T=330$ pF	18	20	22	kHz
f_{osc2}	Oscillation Frequency 2	$R_T=1$ k Ω , $C_T=1$ nF	210	250	290	kHz
D	Duty Cycle	Running Mode	47.5	49.0		%
V_{RCT+}	Upper Threshold Voltage of RCT	Running Mode		V_{DD}		V
V_{RCT-}	Lower Threshold Voltage of RCT	Running Mode		$V_{DD}/4$		V
V_{IH}	Logic "1" Input Voltage of RCT	Running Mode		$3/4 V_{DD}$		V
V_{IL}	Logic "0" Input Voltage of RCT	Running Mode			$3/5 V_{DD}$	V
t_D	Dead-Time	$R_{DT}=100$ k Ω	500	600	700	ns
t_{DMIN}	Minimum Dead-Time	$V_{DT/SD}=V_{DD}$	300	400	500	ns
Output Characteristics						
I_{O+}	Output High, Short-Circuit Pulse Current ⁽³⁾	$PW \leq 10$ μ s		350		mA
I_{O-}	Output Low, Short-Circuit Pulse Current ⁽³⁾	$PW \leq 10$ μ s		650		mA
V_S	Allowable Negative V_S Pin voltage for Input Signal (V_{RCT}) Propagation to HO			-9.8	-7.0	V

Continued on the following page...

Electrical Characteristics (Continued)

V_{BIAS} (V_{DD} , $V_B - V_S$)=14.0 V, C_L =1 nF, R_T =50 k Ω and C_T =330 pF and T_A =25°C, unless otherwise specified.

Symbol	Parameter	Conditions	Min.	Typ.	Max.	Unit
Output Characteristics						
t_{ON}	Turn-On Propagation Time	$V_{DD}=V_{BS}=14$ V, $V_{DT/SD}=V_{DD}$, $V_{RCT}=4$ V~ V_{DD} , $f_{OSC}=20$ kHz		550		ns
t_{OFF}	Turn-Off Propagation Time	$V_{DD}=V_{BS}=14$ V, $V_{DT/SD}=V_{DD}$, $V_{RCT}=4$ V~ V_{DD} , $f_{OSC}=20$ kHz		160		ns
t_R	Turn-On Rising Time	$C_L=1000$ pF		50	120	ns
t_F	Turn-Off Falling Time	$C_L=1000$ pF		50	70	ns
Protection Characteristics						
/SD+	Shutdown "1" Input Voltage		2.0			V
/SD-	Shutdown "0" Input Voltage					V
I_{SD}	Shutdown Current	$V_{DT/SD}=0$ After Running Mode		250		μ A
t_{SD}	Shutdown Propagation Delay			180		ns

Note:

- These parameters, although guaranteed, is not 100% tested in production.

Switching Definitions

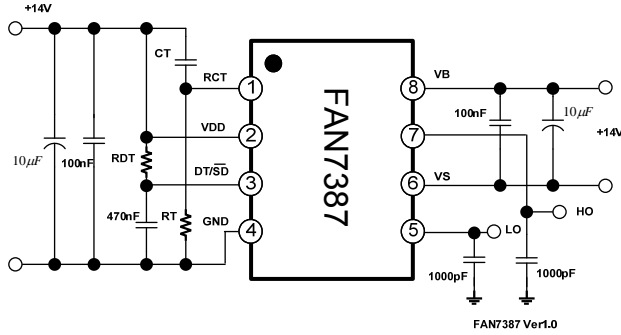

Figure 7. Test Circuit for Self-Oscillation Method

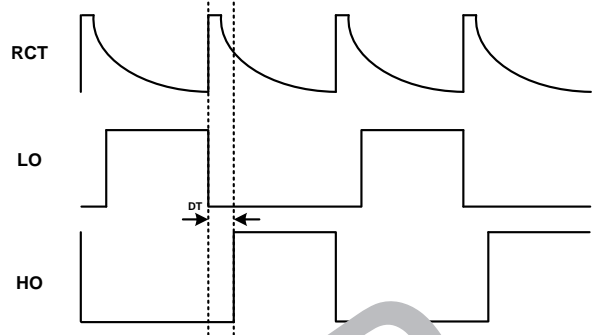

Figure 8. Basic Operating Waveforms of Self-Oscillation Method

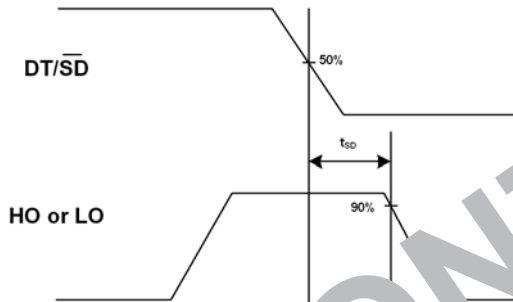

Figure 9. Shutdown Delay Definition

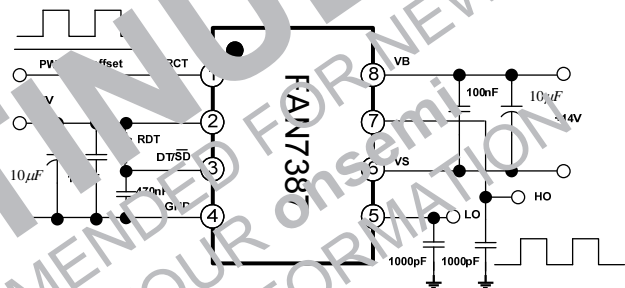

Figure 10. Test Circuit for Forced-Oscillation Method Using External Signal

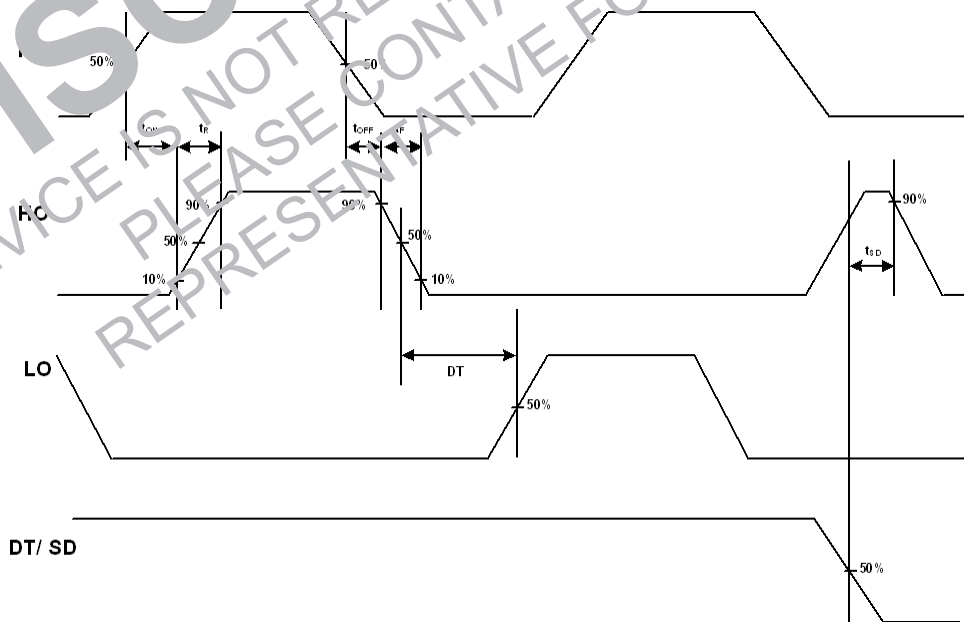

Figure 11. Basic Operation Waveforms of Forced-oscillation Method Using External Signal

Typical Performance Characteristics

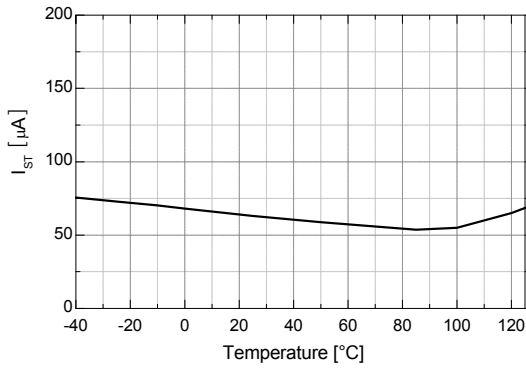

Figure 12. Startup Current vs. Temperature

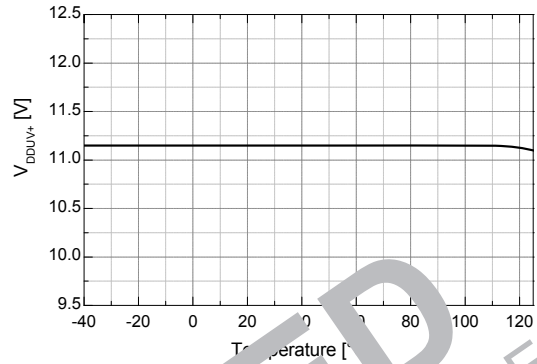

Figure 13. V_{DD(UVLO+)} vs. Temperature

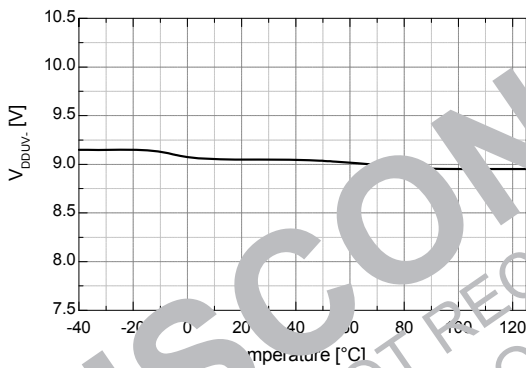

Figure 14. V_{DD(UVLO-)} vs. Temperature

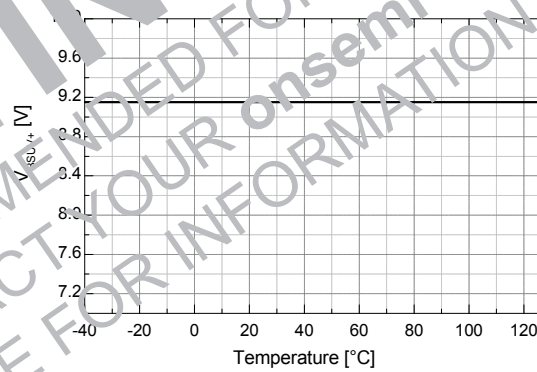

Figure 15. V_{BS(UVLO+)} vs. Temperature

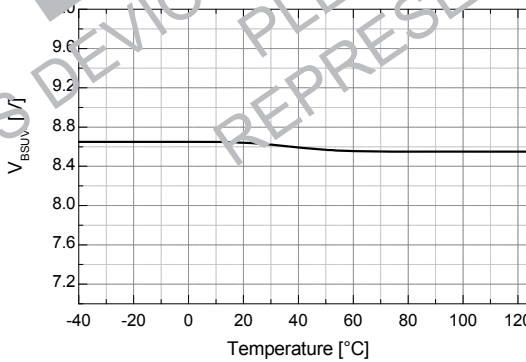

Figure 16. V_{BS(UVLO-)} vs. Temperature

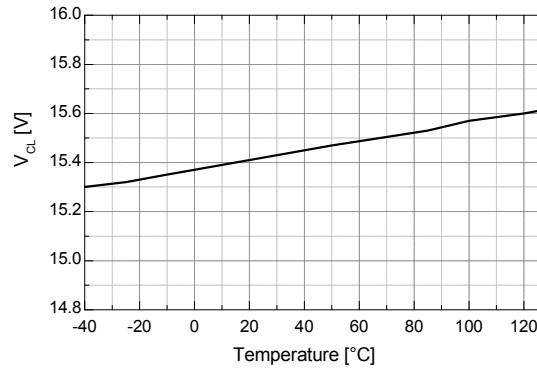

Figure 17. V_{CL} vs. Temperature

Typical Performance Characteristics (Continued)

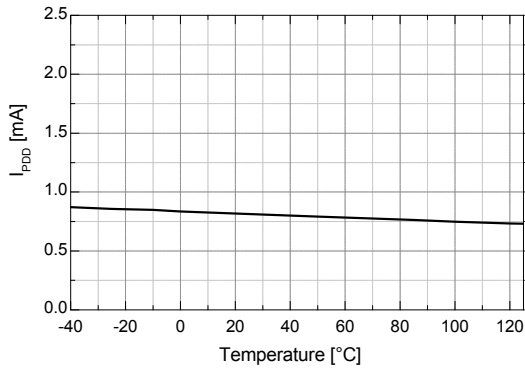

Figure 18. I_{PDD} vs. Temperature

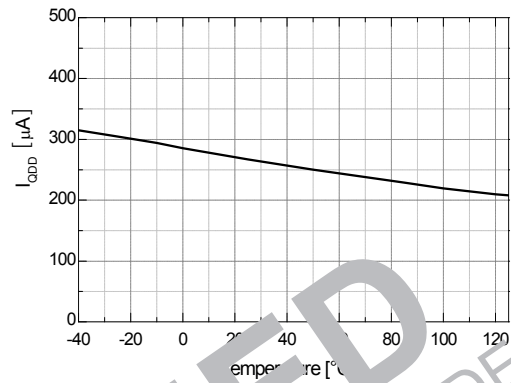

Figure 19. I_{OL} vs. Temperature

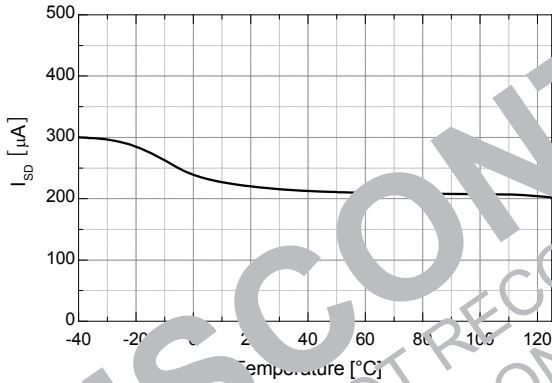

Figure 20. I_{SD} vs. Temperature

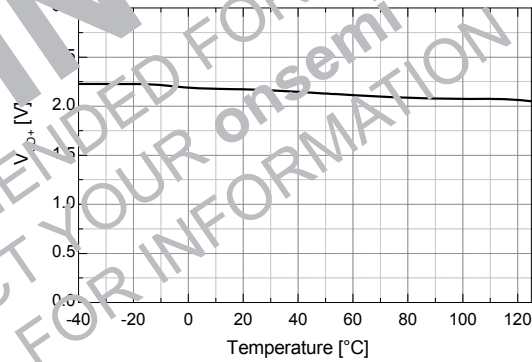

Figure 21. V_{SD+} vs. Temperature

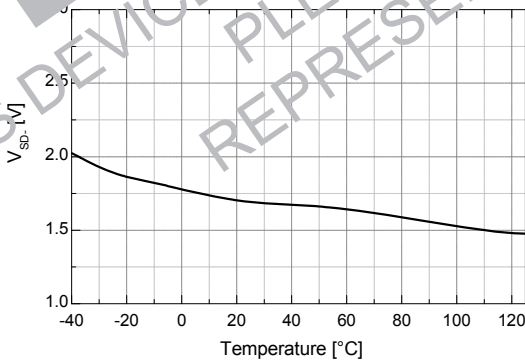

Figure 22. V_{SD-} vs. Temperature

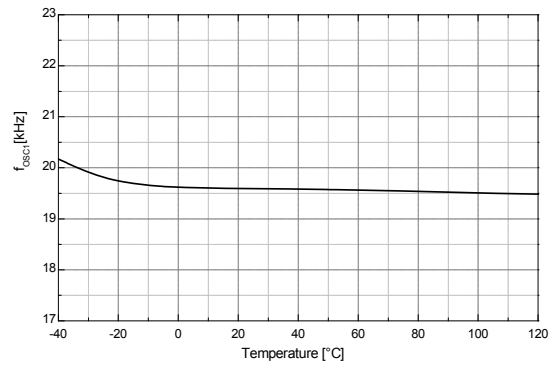

Figure 23. Operating Frequency 1 vs. Temperature

Typical Performance Characteristics (Continued)

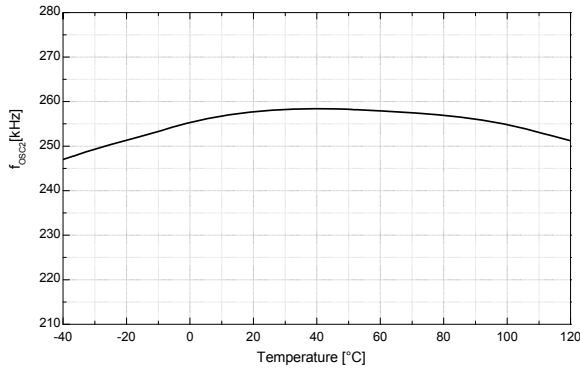

Figure 24. Operating Frequency 2 vs. Temperature

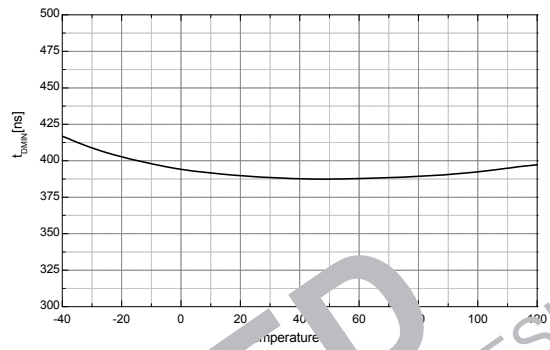

Figure 25. t_{dwell} vs. Temperature

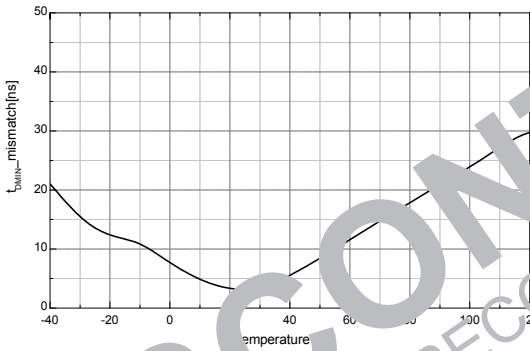

Figure 26. $t_{dwell_mismatch}$ vs. Temperature

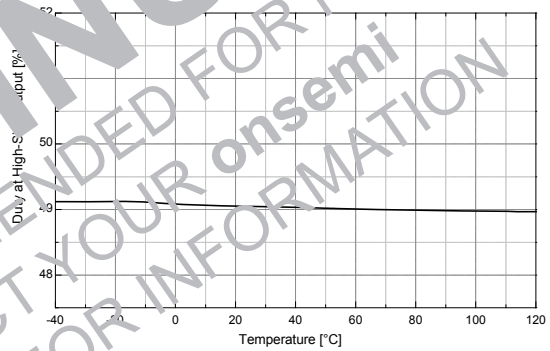

Figure 27. High-Side Duty Ratio vs. Temperature

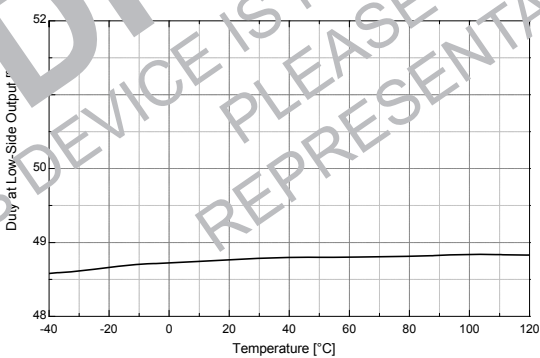

Figure 28. Low-Side Duty Ratio vs. Temperature

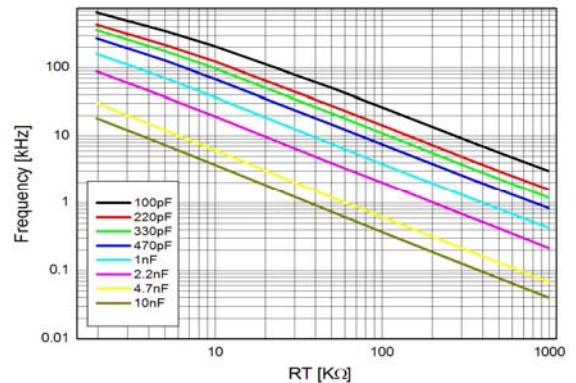

Figure 29. Frequency vs. RT

Functional Description

1. Under-Voltage Lockout (UVLO) Function

FAN7387 has a UVLO circuit for a low-side and high-side block. When V_{DD} reaches to the $V_{DD_{UV+}}$, the UVLO circuit is released and the FAN7387 operates normally. At UVLO condition, the FAN7387 has a low supply current of less than 130 μA . Once UVLO is released, FAN7387 operates normally until V_{DD} goes below $V_{DD_{UV-}}$, the UVLO hysteresis.

FAN7387 also has a high-side gate driver. The supply for the high-side driver is applied between V_B and V_S . To prevent malfunction at low supply voltage between V_B and V_S , FAN7387 provides an additional UVLO circuit. If $V_B - V_S$ is under $V_{BS_{UV+}}$, the driver holds LOW state to turn off the high-side switch. Once the voltage of $V_B - V_S$ is higher than $V_{BS_{UVH}}$, after $V_B - V_S$ exceeds $V_{BS_{UV-}}$, the operation of driver resumes.

2. Oscillator

The running frequency is determined by an external timing resistor (R_T) and timing capacitor (C_T). The charge time of capacitor C_T from $1/4 V_{DD}$ to V_{DD} determines the running frequency of LO and HO gate driver output. Figure 30 shows connection configuration

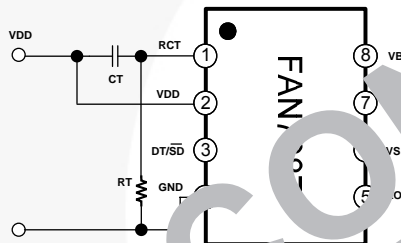

Figure 30. Typical Connection Method

Figure 31 shows the typical waveforms of RCT, LO, and HO. From the circuit analysis, the discharging time of RCT is given by Equation 1:

$$V_{RCT} = V_{DD} \times \ln\left(\frac{-t}{R_T \times C_T}\right) \quad (1)$$

Equation 1 enables calculation of discharging time, t , from V_{DD} to $1/4 V_{DD}$ by substituting $V_{RCT(t)}$ with $1/4 V_{DD}$.

$$t = 1.38 \times R_T \times C_T \quad (2)$$

The running frequency of IC is determined by $1/T$ and is approximately given as:

$$f_{\text{running}} = \frac{1}{T} = \frac{1}{2(t + T_{\text{fix}})} \quad (3)$$

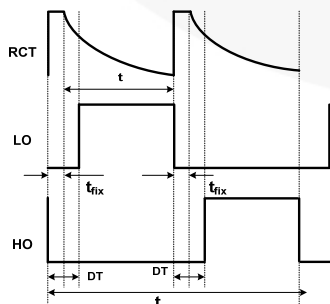

Figure 31. Typical Waveforms of RCT, LO and HO

where, t is the discharging time of the RCT voltage and t_{fix} is constant value about 450 ns of IC.

3. Programming Dead-Time Control / Shutdown

A multi-function pin controls dead-time using an external resistor (R_{DT}) and protects abnormal condition using an external switch. This pin should be connected to an external capacitor to maintain stable operation.

If the voltage of DT/SD is decreased under 1 V by an external switch, such as the TR or MOSFET, the FAN7387 enters shutdown mode. In this mode, the FAN7387 doesn't have any output signal.

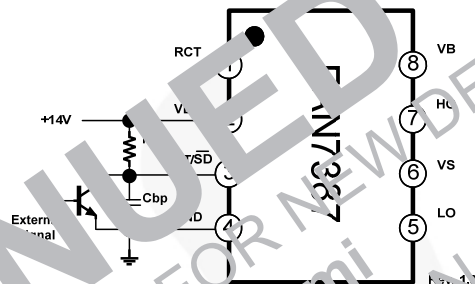

Figure 32. External Shutdown Circuit

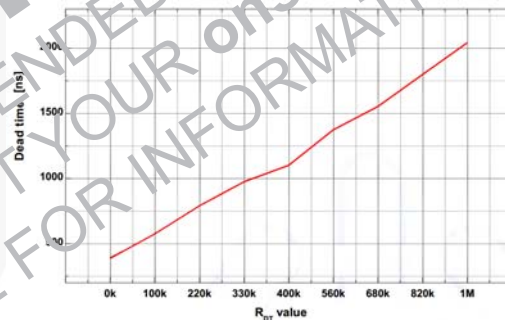

Figure 33. Adjustable Dead Time

4. Gate Driver Operation

The FAN7387 has a two operating modes. One is the self-oscillation mode by using external timing resistor (R_T) and external timing capacitor (C_T) and the other is the forced oscillation mode by external PWM signal comes from U-com and the other devices.

Figure 33 shows operation of the IC using an external PWM circuit with additional resistors (R_1 and R_2) for internal limitation of the IC. The input signal range from an external circuit must be within $3/5 V_{DD}$ and $3/4 V_{DD}$. The external signal produces the HO and LO output and HO signal is in-phase with the external input signal.

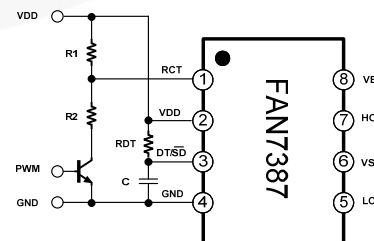

Figure 34. Gate Driver Using External PWM Signal

Physical Dimensions

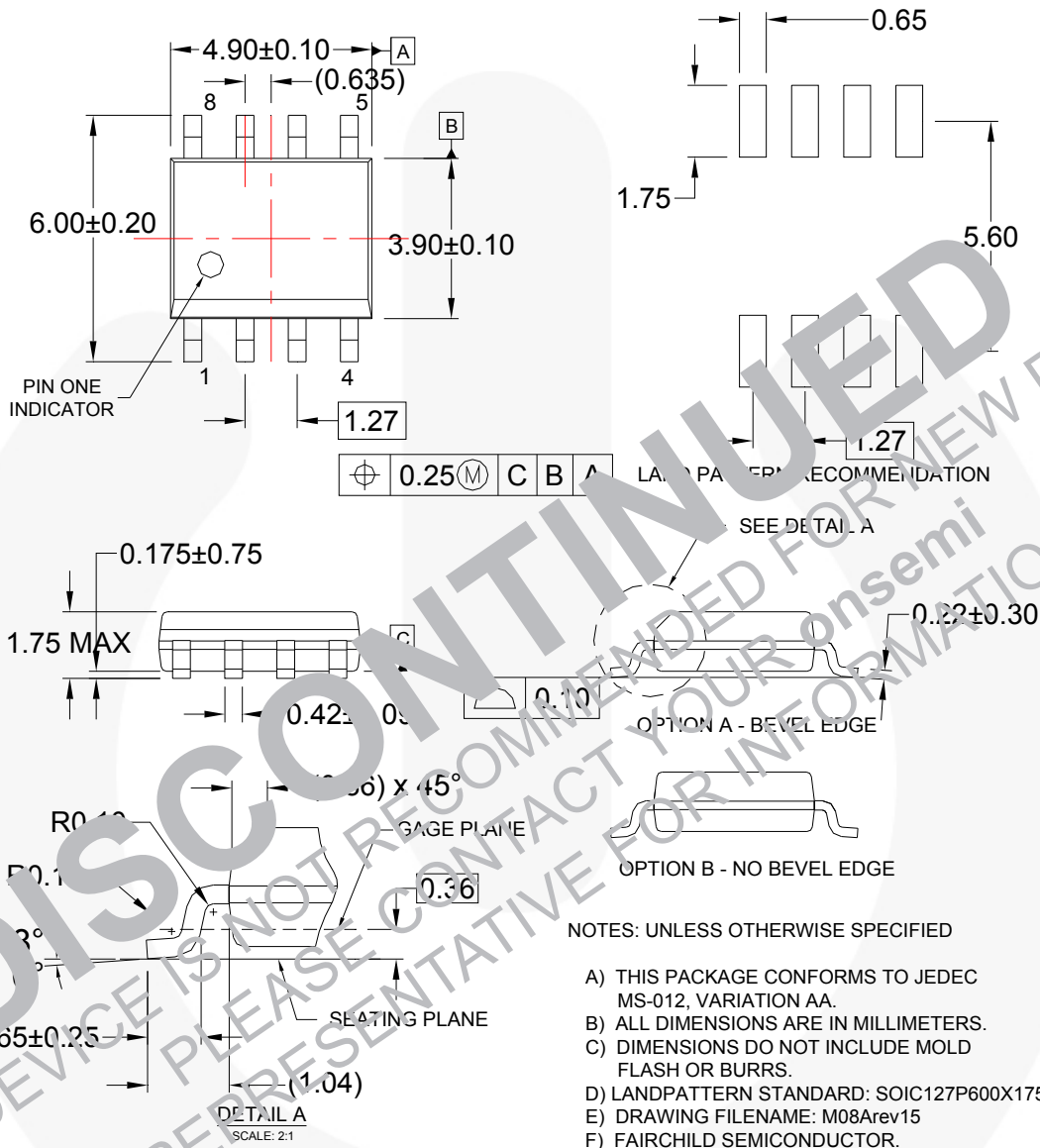

Figure 35. 8-Lead Small Outline Package (SOP)

Package drawings are provided as a service to customers considering Fairchild components. Drawings may change in any manner without notice. Please note the revision and/or date on the drawing and contact a Fairchild Semiconductor representative to verify or obtain the most recent revision. Package specifications do not expand the terms of Fairchild's worldwide terms and conditions, specifically the warranty therein, which covers Fairchild products.

Always visit Fairchild Semiconductor's online packaging area for the most recent package drawings:
<http://www.fairchildsemi.com/dwg/M0/M08A.pdf>



TRADEMARKS

The following includes registered and unregistered trademarks and service marks, owned by Fairchild Semiconductor and/or its global subsidiaries, and is not intended to be an exhaustive list of all such trademarks.

- | | | | |
|--------------------------|--|-----------------------------|-------------------|
| AccuPower™ | F-PFST™ | PowerTrench® | SYSTEM GENERAL® |
| AX-CAP® | FRFET® | PowerXS™ | TinyBoost® |
| BitSIC™ | Global Power Resource™ | Programmable Active Droop™ | TinyBuck® |
| Build it Now™ | GreenBridge™ | QFET® | TinyCalc™ |
| CorePLUS™ | Green FPS™ | QST™ | TinyLogic® |
| CorePOWER™ | Green FPS™ e-Series™ | Quiet Series™ | TINYOPTO™ |
| CROSSVOLT™ | Gmax™ | RapidConfigure™ | TinyPower™ |
| CTL™ | GTO™ | SignalMiser™ | TinyPWM™ |
| Current Transfer Logic™ | IntelliMAX™ | SmartMax™ | TinyV™ |
| DEUXPEED® | ISOPLANAR™ | SMART START™ | TransiC™ |
| Dual Cool™ | Making Small Speakers Sound Louder and Better™ | Solutions for Your Success™ | TriFault Protect™ |
| EcoSPARK® | MegaBuck™ | SPM® | TRIPLE CURRENT® |
| EfficientMax™ | MICROCOUPLER™ | STEALTH™ | UHC® |
| ESBC™ | MicroFET™ | SuperFET® | Ultra FRFET™ |
| F [®] | MicroPak™ | SuperFET™3 | UniFET™ |
| Fairchild® | MicroPak2™ | SuperMOS™ | VCX™ |
| Fairchild Semiconductor® | MillerDrive™ | SynMOS™ | VisualMax™ |
| FACT Quiet Series™ | MotionMax™ | SynMOS™ | VoltagePlus™ |
| FACT® | mW saver® | SynMOS™ | VOLTA™ |
| FAST® | OptoHi™ | SynMOS™ | 山童™ |
| FastyCore™ | OPTOLOGIC® | SynMOS™ | |
| FETBench™ | OPTOPLANAR® | SynMOS™ | |
| FPST™ | | SynMOS™ | |

* Trademarks of System General Corporation, used under license by Fairchild Semiconductor.

DISCLAIMER

FAIRCHILD SEMICONDUCTOR RESERVES THE RIGHT TO MAKE CHANGES WITHOUT FURTHER NOTICE TO ANY PRODUCTS HEREIN TO IMPROVE RELIABILITY, FUNCTION, OR DESIGN. FAIRCHILD DOES NOT ASSUME ANY LIABILITY ARISING OUT OF THE APPLICATION OR USE OF ANY PRODUCT OR CIRCUIT DESCRIBED HEREIN; NEITHER DOES IT GIVE ANY LICENSE UNDER ITS PATENT RIGHTS, NOR THE RIGHTS OF OTHERS. THESE SPECIFICATIONS DO NOT EXPAND THE TERMS OF FAIRCHILD'S WORLDWIDE TERMS AND CONDITIONS, SPECIFICALLY THE WARRANTY THEREIN, WHICH COVERS THESE PRODUCTS.

LIFE SUPPORT POLICY

FAIRCHILD'S PRODUCTS ARE NOT AUTHORIZED FOR USE AS CRITICAL COMPONENTS IN LIFE SUPPORT DEVICES OR SYSTEMS WITHOUT THE EXPRESS WRITTEN APPROVAL OF FAIRCHILD SEMICONDUCTOR CORPORATION.

As used herein:

- Life support devices or systems are devices or systems which, (a) are intended to be surgically implant into the body or (b) support or sustain life, and whose failure to perform when properly used in accordance with instructions for use provided in the labeling, can be reasonably expected to result in a significant injury of the user.
- A critical component in any component of a life support, device, or system whose failure to perform can be reasonably expected to cause the failure of the life support device or system, or to affect its safety or effectiveness.

ANTI-COUNTERFEITING POLICY

Fairchild Semiconductor Corporation's Anti-Counterfeiting Policy. Fairchild's Anti-Counterfeiting Policy is also stated on our external website, www.fairchildsemi.com, under Sales Support.

Counterfeiting of semiconductor parts is a growing problem in the industry. All manufacturers of semiconductor products are experiencing counterfeiting of their parts. Customers who inadvertently purchase counterfeit parts experience many problems such as loss of brand reputation, substandard performance, failed applications, and increased cost of production and manufacturing delays. Fairchild is taking strong measures to protect ourselves and our customers from the proliferation of counterfeit parts. Fairchild strongly encourages customers to purchase Fairchild parts either directly from Fairchild or from Authorized Fairchild Distributors who are listed by country on our web page cited above. Products customers buy either from Fairchild directly or from Authorized Fairchild Distributors are genuine parts, have full traceability, meet Fairchild's quality standards for handling and storage and provide access to Fairchild's full range of up-to-date technical and product information. Fairchild and our Authorized Distributors will stand behind all warranties and will appropriately address any warranty issues that may arise. Fairchild will not provide any warranty coverage or other assistance for parts bought from Unauthorized Sources. Fairchild is committed to combat this global problem and encourage our customers to do their part in stopping this practice by buying direct or from authorized distributors.

PRODUCT STATUS DEFINITIONS

Definition of Terms

Datasheet Identification	Product Status	Definition
Advance Information	Formative / In Design	Datasheet contains the design specifications for product development. Specifications may change in any manner without notice.
Preliminary	First Production	Datasheet contains preliminary data; supplementary data will be published at a later date. Fairchild Semiconductor reserves the right to make changes at any time without notice to improve design.
No Identification Needed	Full Production	Datasheet contains final specifications. Fairchild Semiconductor reserves the right to make changes at any time without notice to improve the design.
Obsolete	Not In Production	Datasheet contains specifications on a product that is discontinued by Fairchild Semiconductor. The datasheet is for reference information only.

Rev. I68

DISCONTINUED
THIS DEVICE IS NOT RECOMMENDED FOR NEW DESIGN
PLEASE CONTACT YOUR onsemi
REPRESENTATIVE FOR INFORMATION

ON Semiconductor and  are trademarks of Semiconductor Components Industries, LLC dba ON Semiconductor or its subsidiaries in the United States and/or other countries. ON Semiconductor owns the rights to a number of patents, trademarks, copyrights, trade secrets, and other intellectual property. A listing of ON Semiconductor's product/patent coverage may be accessed at www.onsemi.com/site/pdf/Patent-Marking.pdf. ON Semiconductor reserves the right to make changes without further notice to any products herein. ON Semiconductor makes no warranty, representation or guarantee regarding the suitability of its products for any particular purpose, nor does ON Semiconductor assume any liability arising out of the application or use of any product or circuit, and specifically disclaims any and all liability, including without limitation special, consequential or incidental damages. Buyer is responsible for its products and applications using ON Semiconductor products, including compliance with all laws, regulations and safety requirements or standards, regardless of any support or applications information provided by ON Semiconductor. "Typical" parameters which may be provided in ON Semiconductor data sheets and/or specifications can and do vary in different applications and actual performance may vary over time. All operating parameters, including "Typicals" must be validated for each customer application by customer's technical experts. ON Semiconductor does not convey any license under its patent rights nor the rights of others. ON Semiconductor products are not designed, intended, or authorized for use as a critical component in life support systems or any FDA Class 3 medical devices or medical devices with a same or similar classification in a foreign jurisdiction or any devices intended for implantation in the human body. Should Buyer purchase or use ON Semiconductor products for any such unintended or unauthorized application, Buyer shall indemnify and hold ON Semiconductor and its officers, employees, subsidiaries, affiliates, and distributors harmless against all claims, costs, damages, and expenses, and reasonable attorney fees arising out of, directly or indirectly, any claim of personal injury or death associated with such unintended or unauthorized use, even if such claim alleges that ON Semiconductor was negligent regarding the design or manufacture of the part. ON Semiconductor is an Equal Opportunity/Affirmative Action Employer. This literature is subject to all applicable copyright laws and is not for resale in any manner.

PUBLICATION ORDERING INFORMATION

LITERATURE FULFILLMENT:



Literature Distribution Center for ON Semiconductor
19521 E. 32nd Pkwy, Aurora, Colorado 80011 USA
Phone: 303-675-2175 or 800-344-3860 Toll Free USA/Canada
Fax: 303-675-2176 or 800-344-3867 Toll Free USA/Canada
Email: orderlit@onsemi.com

N. American Technical Support: 800-282-9855 Toll Free
USA/Canada
Europe, Middle East and Africa Technical Support:
Phone: 421 33 790 2910
Japan Customer Focus Center
Phone: 81-3-5817-1050

ON Semiconductor Website: www.onsemi.com
Order Literature: <http://www.onsemi.com/orderlit>
For additional information, please contact your local
Sales Representative

Looking for pricing, stock, or lifecycle information?

Click below to explore more details on WIN SOURCE:

-  [View FAN7387MX on WIN SOURCE](#)
-  [Fairchild/ON Semiconductor Information](#)

Optimize Your Supply Chain with WIN SOURCE Solutions

-  Global Sourcing Solution
-  Obsolete Management
-  Cost Control Management
-  Shortage Management
-  Alternative Solution
-  Excess Inventory Management