



**THE DATASHEET OF
DPS1035FIA-13**



24V/3.5A 1-CH POWER SWITCH W/ REVERSE-VOLTAGE PROTECTION

OBSOLETE – PART DISCONTINUED

Description

The DPS1035 is part of a family of power switches optimized for the USB Type-C® and other hot-swap applications. Through the analog interface, exception status is reported and functions like voltage limiting and output voltage ramp-up rate can be programmed.

This device is designed to operate between 4.5V and 24V. Its built-in fault-handling mechanism includes reverse voltage and current blocking, input over-voltage protection, and thermal shutdown. In addition, the ramp-up time of the output voltage can be adjusted to minimize in-rush current and to ensure system stability. Before any exception condition is notified via the low-active FAULTB signal, de-glitch of 7ms is applied to prevent false triggering.

The DPS1035 is housed in the low-profile and space-saving V-QFN4040-17 package which is manufactured with environmentally friendly material.

Features

- Wide Operating Voltage Range: 4.5V to 24V
- 1-Channel Power Switch with Built-In Fault Detection and Recovery Mechanisms like Input Under-Voltage Lockout, Reverse-Voltage and Current Blocking, Thermal Shutdown and Input Over-Voltage Protection
- $R_{DS(ON)}$ of Embedded Power MOSFET at 30mΩ
- Adjustable DV/DT Control at Start-Up
- Manual Discharge ON/OFF Control for IN and OUT Ports
- Fault Reporting (FAULTB) with Blanking Time at 7ms Typical
- **Totally Lead-Free & Fully RoHS Compliant (Notes 1 & 2)**
- **Halogen and Antimony Free. "Green" Device (Note 3)**
- **For automotive applications requiring specific change control (i.e. parts qualified to AEC-Q100/101/104/200, PPAP capable, and manufactured in IATF 16949 certified facilities), please [contact us](#) or your local Diodes representative. <https://www.diodes.com/quality/product-definitions/>**

Notes:

1. No purposely added lead. Fully EU Directive 2002/95/EC (RoHS), 2011/65/EU (RoHS 2) & 2015/863/EU (RoHS 3) compliant.
2. See <https://www.diodes.com/quality/lead-free/> for more information about Diodes Incorporated's definitions of Halogen- and Antimony-free, "Green" and Lead-free.
3. Halogen- and Antimony-free "Green" products are defined as those which contain <900ppm bromine, <900ppm chlorine (<1500ppm total Br + Cl) and <1000ppm antimony compounds.

Pin Assignments

(Top View)

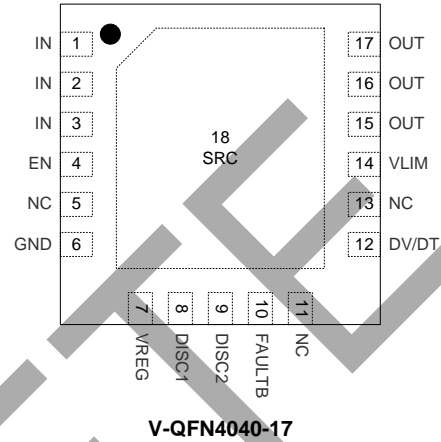

Applications

- Notebooks, desktops and AIO PCs; servers and tablets
- Docking stations, universal and multimedia hubs
- FPTVs, PC monitors
- Set-Top boxes, residential gateways, storage devices

OBSOLETE - PART DISCONTINUED

Typical Application Circuit

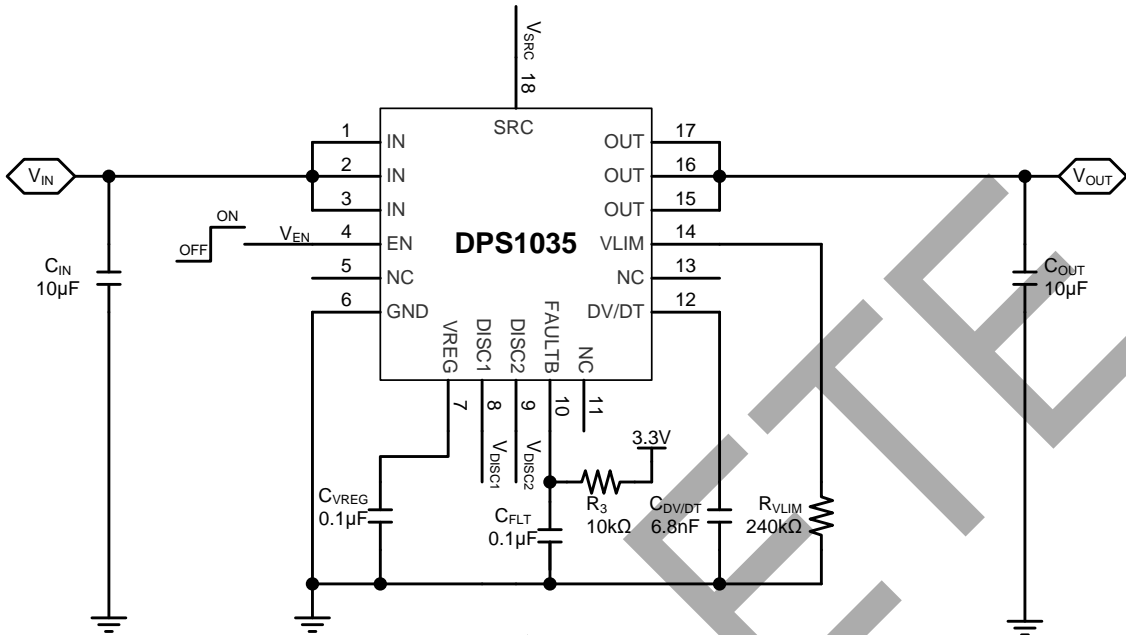

Pin Descriptions

Pin Number	Pin Name	Type	Function
1, 2, 3	IN	P	Power Supply and Input Port.
4	EN	I	Enable. '0' = device OFF; '1' = device ON. This pin must not be left floating.
5, 11, 13	NC	—	No Connection. All NC pins must be left floating.
6	GND	GND	Device Ground
7	VREG	I/O	Voltage Regulator. A 0.1µF capacitor is recommended between this pin and ground.
8	DISC1	I	IN Port Discharge Control. '1' = port voltage to be discharged; '0' = disabled.
9	DISC2	I	OUT Port Discharge Control. '1' = port voltage to be discharged; '0' = disabled.
10	FAULTB	O	Fault Status Indicator. An external pull-up resistor is required. This active-low pin shall be tied to GND when not used.
12	DV/DT	I/O	Ramp-up Control. A capacitor between this pin and GND sets the ramp-up rate.
14	VLIM	I/O	Voltage Limit Setting. A resistor between this pin and GND sets the over-voltage limit of the IN port.
15, 16, 17	OUT	O	Output Port.
18 (Exposed Pad)	SRC	I/O	Common Source. The exposed pad of the V-QFN4040-17 package must not be connected to any signal.

OBSOLETE - PART DISCONTINUED

Functional Block Diagram

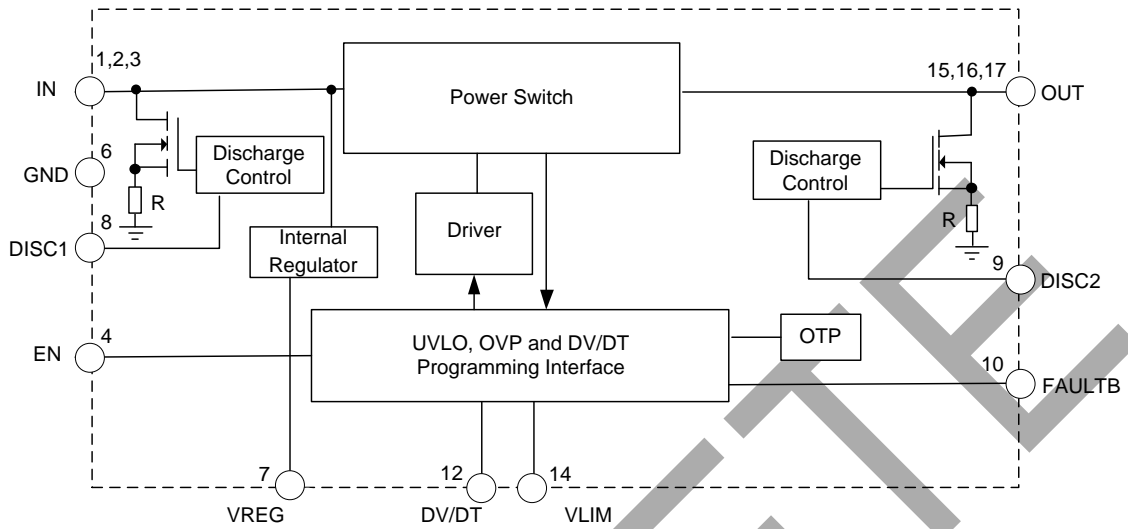

Absolute Maximum Ratings (@ $T_A = +25^\circ\text{C}$, unless otherwise specified.) (Note 4)

Symbol	Parameter	Rating	Unit
V_{IN}, V_{OUT}	Voltage Range of IN and OUT Pins	-0.3 to 30	V
$V_{I/O}$	Voltage Range of Others (EN, VREG, DISC1, DISC2, FAULTB, DV/DT and VLIM Pin)	-0.3 to 6	V
I_{OUT}	Output Load Current Range	5	A
T_J	Operating Junction Temperature	-40 to +125	$^\circ\text{C}$
T_L	Lead Temperature	+260	$^\circ\text{C}$
T_{ST}	Storage Temperature	-65 to +150	$^\circ\text{C}$
ESD	Human Body Model (HBM), JESD22-A114	2	kV
	Charge Device Model (CDM)	0.5	

Note: 4. These are stress ratings only. Operation outside the absolute maximum ratings can cause device failure. Operation at the absolute maximum rating for extended periods can reduce device reliability.

Thermal Characteristics (@ $T_A = +25^\circ\text{C}$, unless otherwise specified.) (Note 5)

Symbol	Parameter	Rating	Unit
P_D	Power Dissipation	2.1	W
$R_{\theta JA}$	Thermal Resistance, Junction-to-Ambient	58.5	$^\circ\text{C}/\text{W}$
$R_{\theta JC}$	Thermal Resistance, Junction-to-Case	9.4	$^\circ\text{C}/\text{W}$

Note: 5. Device mounted on FR-4 substrate PC board, 2oz copper, with 1"x1" copper pad layout.

OBSOLETE – PART DISCONTINUED

Recommended Operating Conditions (@ T_A = +25°C, unless otherwise specified.)

Symbol	Parameter	Min	Max	Unit
V _{IN}	Input Supply Voltage	4.5	24	V
V _{OUT}	Output Voltage	0	24	V
I _{OUT}	Output Load Current	0	3.5	A
C _{IN}	Input Capacitance	1	—	μF
C _{OUT}	Output Capacitance	1	—	μF
V _{EN}	Input Voltage on EN	0	5	V
V _{DISC1} , V _{DISC2}	Input Voltage on DISC1 and DISC2	0	5.5	V

Electrical Characteristics

(@ T_A = +25°C, V_{IN} = 4.5V to 24V, C_{IN} = C_{OUT} = 10μF, V_{EN} = 3.3V, C_{DV/DT} = 1nF, R_{VLM} = 240kΩ, unless otherwise specified.)

Symbol	Parameter	Condition	Min	Typ	Max	Unit
Bias Supply						
V _{UVLO}	V _{IN} Under-Voltage Lockout Threshold	V _{IN} Rising	3.2	3.7	4	V
V _{UVHY}	V _{IN} Under-Voltage Lockout Threshold Hysteresis	V _{IN} Falling	—	250	—	mV
I _{SHDN}	Shutdown Current (Disabled)	V _{IN} = 5V, V _{EN} = 0V	—	—	10	μA
		V _{IN} = 12V, V _{EN} = 0V	—	—	25	
		V _{IN} = 20V, V _{EN} = 0V	—	—	50	
I _Q	Quiescent Current (Enabled)	V _{IN} = 5V, No Load	—	—	3	mA
		V _{IN} = 12V, No Load	—	—	4	
		V _{IN} = 20V, No Load	—	—	4.5	
Enable Control						
V _{ENL}	EN Threshold Voltage Low	V _{EN} Falling	—	—	0.4	V
V _{ENH}	EN Threshold Voltage High	V _{EN} Rising	1.4	—	—	
I _{EN}	EN Input Leakage Current	V _{IN} = 5V, V _{EN} = 5V	—	—	1	μA
Over-Voltage Protection						
I _{VLM}	V _{LM} Sourcing Current	V _{IN} = 5V, R _{VLM} = 57.6kΩ	—	10	—	μA
R _{VLM_MAX}	Maximum R _{VLM}	—	—	—	300	kΩ
V _{OVPRTH}	Input Over-Voltage Threshold, Rising	R _{VLM} = 57.6kΩ, V _{IN} Rising	—	6	—	V
		R _{VLM} = 240kΩ, V _{IN} Rising	—	24	—	
V _{OVPFTH}	Input Over-Voltage Threshold, Falling	R _{VLM} = 57.6kΩ, V _{IN} Falling	—	5.6	—	V
		R _{VLM} = 240kΩ, V _{IN} Falling	—	23.6	—	
MOSFET						
R _{DS(ON)}	Switch ON Resistance	V _{IN} = 5V, I _{OUT} = 1A	—	30	40	mΩ
		V _{IN} = 12V, I _{OUT} = 1A	—	30	40	
		V _{IN} = 20V, I _{OUT} = 1A	—	30	40	
I _{LKGSRC}	OUT Leakage Current in OFF State, Sourcing	V _{EN} = 0V, V _{OUT} = 0V	—	—	1	μA
I _{LKGSNK}	OUT Leakage Current in OFF State, Sinking	V _{IN} = 3.3V, V _{EN} = 0V, V _{OUT} = 5V	—	—	1	μA
		V _{IN} = 3.3V, V _{EN} = 0V, V _{OUT} = 12V	—	—	1	
		V _{IN} = 3.3V, V _{EN} = 0V, V _{OUT} = 20V	—	—	1	
Reverse-Voltage Protection						
V _{RVPFTH}	V _{IN} - V _{OUT} Threshold Entering into Reverse Protection	V _{IN} - V _{OUT} Falling	—	-40	—	mV
V _{RVPRTH}	V _{IN} - V _{OUT} Threshold Exiting from Reverse Protection	V _{IN} - V _{OUT} Rising	-15	0	—	
t _{RVPTD}	Reverse Protection Response Time	—	—	—	2	μs

OBSOLETE - PART DISCONTINUED

Electrical Characteristics (continued)

(@T_A = +25°C, V_{IN} = 4.5V to 24V, C_{IN} = C_{OUT} = 10µF, V_{EN} = 3.3V, C_{DV/DT} = 1nF, R_{V LIM} = 240kΩ, unless otherwise specified.)

Symbol	Parameter	Condition	Min	Typ	Max	Unit
Output Ramping Control						
I _{DV/DT}	DV/DT Sourcing Current	V _{DV/DT} = 0V	—	1	—	µA
G _{DV/DT}	DV/DT to OUT Gain	ΔV _{OUT} / ΔV _{DV/DT} , Guaranteed by Design	—	12	—	V/V
Output Timing						
t _{DON}	Output Turn-ON Delay Time	V _{IN} = 5V, C _{OUT} = 1µF, V _{EN} = 0V to 2V	—	0.2	—	ms
		V _{IN} = 12V, C _{OUT} = 1µF, V _{EN} = 0V to 2V	—	0.2	—	
		V _{IN} = 20V, C _{OUT} = 1µF, V _{EN} = 0V to 2V	—	0.2	—	
t _R	Output Turn-ON Rise Time	V _{IN} = 5V, C _{OUT} = 1µF, V _{EN} = 0V to 2V	—	0.3	—	ms
		V _{IN} = 12V, C _{OUT} = 1µF, V _{EN} = 0V to 2V	—	0.8	—	
		V _{IN} = 20V, C _{OUT} = 1µF, V _{EN} = 0V to 2V	—	1.6	—	
t _{DOFF}	Output Turn-OFF Delay Time	V _{IN} = 5V, C _{OUT} = 1µF, V _{EN} = 2V to 0V	—	1	—	µs
		V _{IN} = 12V, C _{OUT} = 1µF, V _{EN} = 2V to 0V	—	2	—	
		V _{IN} = 20V, C _{OUT} = 1µF, V _{EN} = 2V to 0V	—	4	—	
t _F	Output Turn-OFF Fall Time	V _{IN} = 5V, C _{OUT} = 1µF, V _{EN} = 2V to 0V	—	10	—	µs
		V _{IN} = 12V, C _{OUT} = 1µF, V _{EN} = 2V to 0V	—	25	—	
		V _{IN} = 20V, C _{OUT} = 1µF, V _{EN} = 2V to 0V	—	50	—	
Discharge Control on IN/OUT Pins						
R _{DISC1/DISC2}	IN/OUT Discharge Resistance	V _{DISC1} = 5V, V _{DISC2} = 5V	—	70	—	Ω
		V _{DISC1} = 3.3V, V _{DISC2} = 3.3V	—	82	—	Ω
V _{DISC1L} / V _{DISC2L}	DISC1/DISC2 Threshold Voltage Low	V _{DISC1} /V _{DISC2} Falling	—	—	0.4	V
V _{DISC1H} / V _{DISC2H}	DISC1/DISC2 Threshold Voltage High	V _{DISC1} /V _{DISC2} Rising	1.4	—	—	V
Fault Flag (FAULTB): Active Low						
R _{FAULTB}	FAULTB Pull-Down Resistor	V _{IN} = 7V, R _{V LIM} = 57.6kΩ, I _{FAULTB} = 10mA Sinking	—	25	—	Ω
I _{LKGFAULTB}	FAULTB Leakage Current	V _{IN} = 5V, R _{V LIM} = 57.6kΩ, V _{FAULTB} = 5V	—	—	1	µA
t _{BLANKFAULTB}	FAULTB Blanking Time	V _{IN} = 5V, R _{V LIM} = 57.6kΩ, V _{FAULTB} = 5V	—	7	—	ms
Thermal Shutdown						
T _{SHDN}	Thermal Shutdown Threshold	—	—	+155	—	°C
T _{HYS}	Thermal Shutdown Hysteresis	—	—	+20	—	

Performance Characteristics

(@T_A = +25°C, C_{IN} = C_{OUT} = 10μF, V_{EN} = 3.3V, C_{DV/DT} = 1nF, R_{VLM} = 240kΩ, unless otherwise specified.)

OBSOLETE - PART DISCONTINUED

EN Turn ON and In-Rush Current at 5V

V_{IN} = 5V, R_{LOAD} = 100Ω, C_{OUT} = 100μF, C_{DV/DT} = 10nF

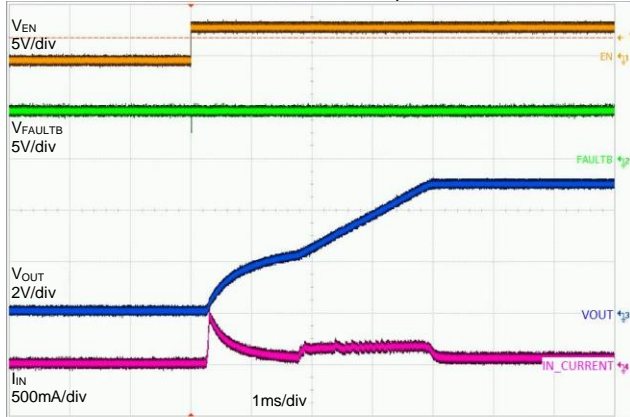

EN Turn OFF at 5V

V_{IN} = 5V, R_{LOAD} = 100Ω, C_{OUT} = 100μF, C_{DV/DT} = 10nF

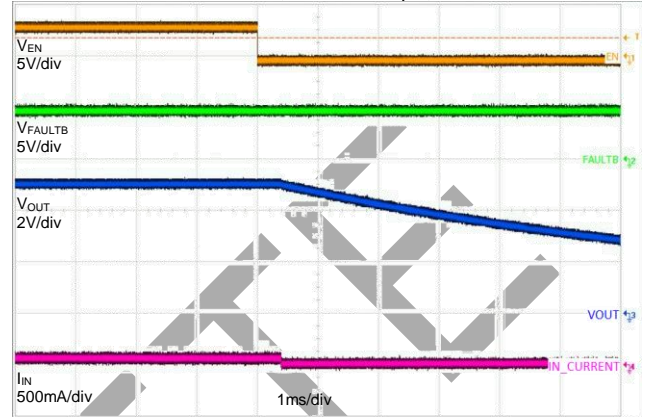

EN Turn ON and In-Rush Current at 20V

V_{IN} = 20V, R_{LOAD} = 100Ω, C_{OUT} = 100μF, C_{DV/DT} = 10nF

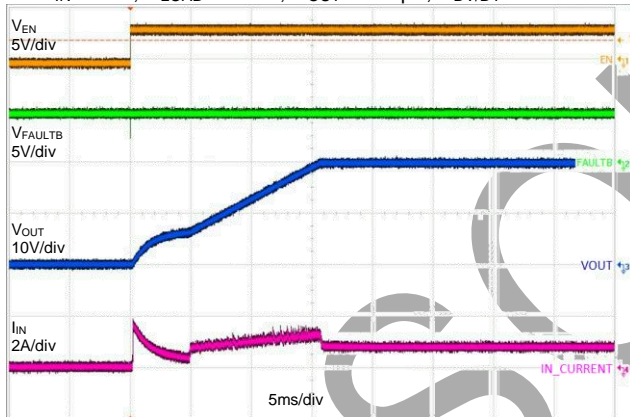

EN Turn OFF at 20V

V_{IN} = 20V, R_{LOAD} = 100Ω, C_{OUT} = 100μF, C_{DV/DT} = 10nF

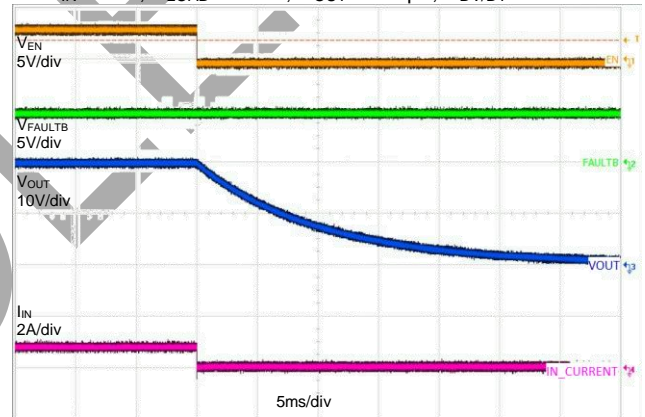

EN Turn ON with a 5.6Ω Load at 20V

V_{IN} = 20V, R_{LOAD} = 5.6Ω

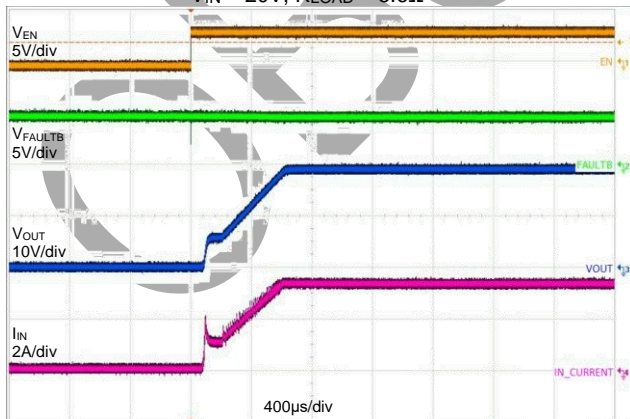

EN Turn OFF with a 5.6Ω Load at 20V

V_{IN} = 20V, R_{LOAD} = 5.6Ω

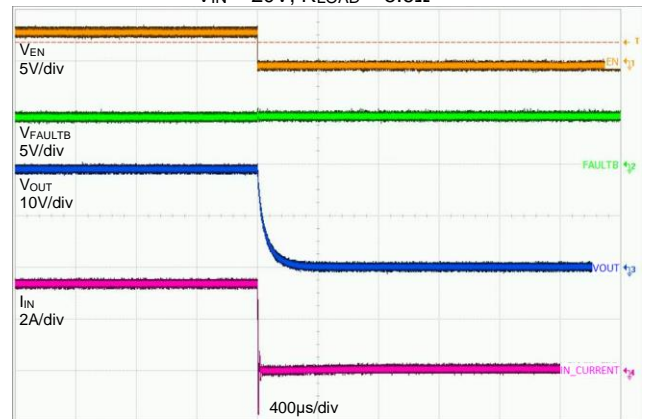

Application Information

General Description

The DPS1035 is a unidirectional power switch designed to meet the input and output voltage/current requirement which is common with many hot-pluggable serial interfaces found in the computing and consumer electronics equipment.

Ramp-Up Time and In-Rush Current Control

An external capacitor connected from the DV/DT pin to GND defines the slew rate of the output voltage at power-on:

$$dV_{OUT} / dt = (I_{DV/DT} / C_{DV/DT}) \times G_{DV/DT}, \text{ where } I_{DV/DT} = 1\mu\text{A typ. and } G_{DV/DT} = 12$$

The total ramp-up time $t_{DV/DT}$ of V_{OUT} , increasing from 0 to V_{IN} , can be calculated using the following equation:

$$t_{DV/DT} = 8.3 \times 10^4 \times V_{IN} \times C_{DV/DT}$$

The in-rush current at power-up shall be limited by the regulated output voltage ramp.

Input Over-Voltage Protection (OVP)

The voltage at the IN port is monitored continuously. Whenever voltage at the IN port is found to be larger than the V_{OVPRTH} value, the built-in over-voltage protection (OVP) fault-handling mechanism is triggered. The internal power MOSFET will be turned OFF to protect the downstream equipment connected. The V_{OVPRTH} value is determined by:

$$V_{OVPRTH} = 0.1 \times R_{VLIM}, \text{ where the unit of } R_{VLIM} \text{ is } k\Omega \text{ and } 51k\Omega \leq R_{VLIM} \leq 240k\Omega.$$

Over-Temperature Protection (OTP)

When the junction temperature T_J reaches the thermal shutdown threshold T_{SHDN} , the internal power MOSFET would be turned OFF. The internal power MOSFET will be turned ON again once the condition $[T_J < (T_{SHDN} - T_{HYS})]$ becomes valid.

Reverse-Voltage Protection (RVP)

The voltage difference, $[V_{IN} - V_{OUT}]$, between the IN and OUT ports is monitored continuously. Once the voltage difference drops below the V_{RVPRTH} level, the device shall immediately turn OFF the internal power MOSFET to prevent the current flowing from the opposite direction. When the reverse-voltage condition is no longer valid, i.e. $[V_{IN} - V_{OUT}]$ becomes greater than the V_{RVPRTH} level, the internal power MOSFET shall be turned ON.

Fault Response

An external pull-up resistor is required. The device generates a warning flag whenever one of the following fault conditions becomes valid: input over-voltage, reversed-voltage, over-temperature. After a de-glitch time-out of 7ms, the low-active FAULTB signal shall be asserted. The FAULTB signal shall remain 'low' and the internal power MOSFET remains OFF until the exception status is no longer valid.

Discharge Function

To facilitate the various applications envisioned by the system designers, the IN and OUT ports can be discharged via two external controls: DISC1, DISC2. The internal discharge resistor is around 80Ω. The settings are shown in the table below.

DISC1	DISC2	Description
0	0	Discharge function disabled
0	1	OUT Port is being discharged until the pin DISC2 is pulled 'low'
1	0	IN Port is being discharged until the pin DISC1 is pulled 'low'
1	1	Both IN and OUT ports are discharged simultaneously

Application Information (continued)

PCB Layout Consideration

1. Place the input and output capacitors, C_{IN} and C_{OUT} , as close as possible to the IN and OUT pins.
2. The power traces, including the power ground, the V_{IN} trace and the V_{OUT} trace should be kept direct, short and wide.
3. Place the resistors and capacitors (R_{VLIM} , $C_{DV/DT}$ and C_{VREG}) as close as possible to the corresponding device pins.
4. Connect the signal ground to the GND pin, and keep a single connection from GND pin to the power ground behind the input capacitor.
5. For better power dissipation, via holes are recommended to connect the exposed pad's landing area to a large copper polygon on the other side of the printed circuit board. The copper polygons and exposed pad of SRC (common source nodes of internal power MOSFET) shall not be connected to any of the signal and power grounds on the printed circuit board.

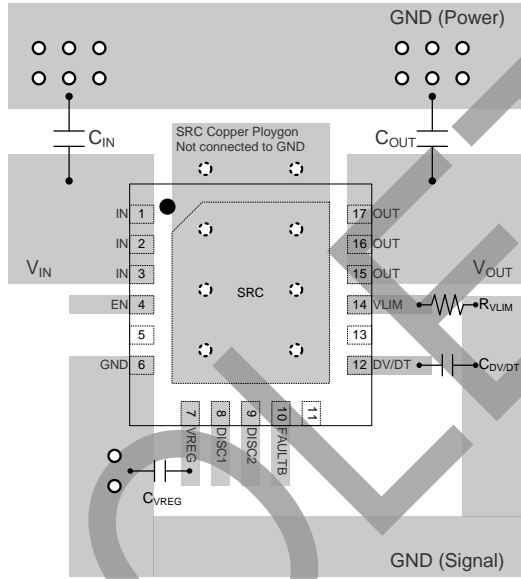
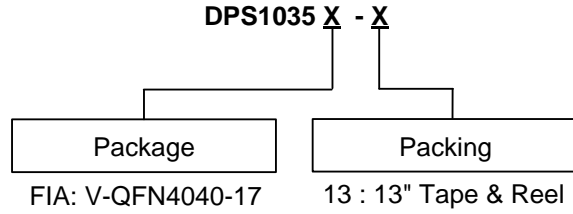

Figure 1. Suggested PCB Layout

OBSOLETE - PART DISCONTINUED

Ordering Information (Note 6)



Part Number	Package	Marking ID	Reel Size (inches)	Tape Width (mm)	Packing	
					Qty.	Carrier
DPS1035FIA-13	V-QFN4040-17	DPS1035	13	12	4,000	13" Tape and Reel

Note: 6. For packaging details, go to our website at <https://www.diodes.com/design/support/packaging/diodes-packaging/>.

Marking Information

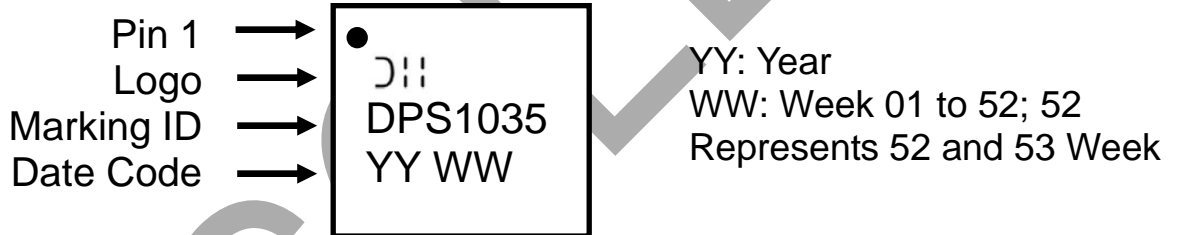

OBSOLETE - PART DISCONTINUED

Package Outline Dimensions

Please see <http://www.diodes.com/package-outlines.html> for the latest version.

V-QFN4040-17

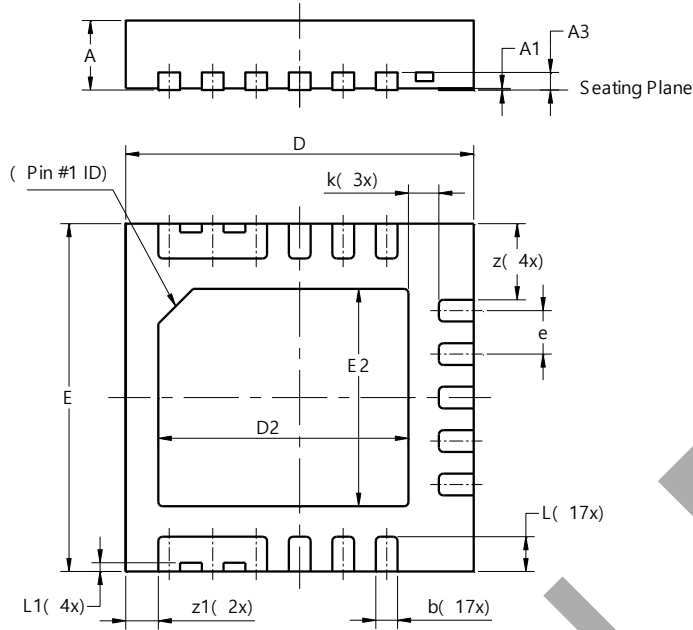

V-QFN4040-17			
Dim	Min	Max	Typ
A	0.75	0.85	0.80
A1	0.00	0.05	0.02
A3	—	—	0.203
b	0.20	0.30	0.25
D	3.95	4.05	4.00
D2	2.775	2.975	2.875
E	3.95	4.05	4.00
E2	2.40	2.60	2.50
e	0.50 BSC		
k	—	—	0.35
L	0.35	0.45	0.40
L1	—	—	0.10
z	—	—	0.875
z1	—	—	0.375
All Dimensions in mm			

Suggested Pad Layout

Please see <http://www.diodes.com/package-outlines.html> for the latest version.

V-QFN4040-17

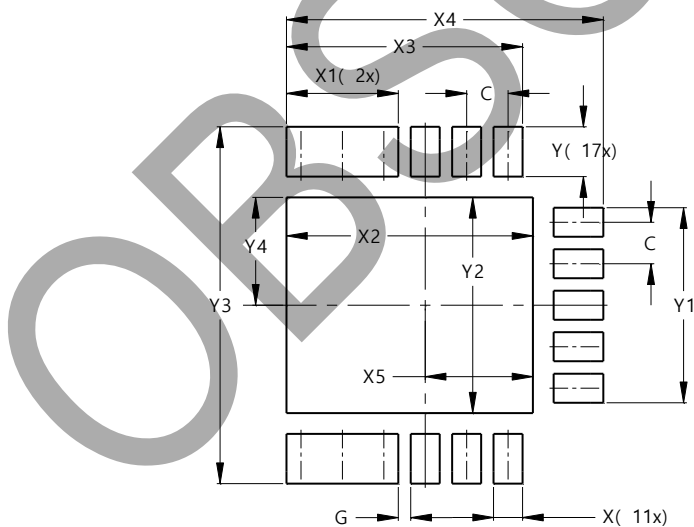

Dimensions	Value (in mm)
C	0.500
G	0.150
X	0.350
X1	1.350
X2	2.975
X3	2.850
X4	3.825
X5	1.300
Y	0.600
Y1	2.350
Y2	2.600
Y3	4.300
Y4	1.300

Mechanical Data

- Moisture Sensitivity: Level 1 per J-STD-020
- Terminals: Finish – NiPdAu over Copper Leadframe. Solderable per MIL-STD-202, Method 208 e4
- Weight: 0.041 grams (Approximate)

IMPORTANT NOTICE

1. DIODES INCORPORATED (Diodes) AND ITS SUBSIDIARIES MAKE NO WARRANTY OF ANY KIND, EXPRESS OR IMPLIED, WITH REGARDS TO ANY INFORMATION CONTAINED IN THIS DOCUMENT, INCLUDING, BUT NOT LIMITED TO, THE IMPLIED WARRANTIES OF MERCHANTABILITY, FITNESS FOR A PARTICULAR PURPOSE OR NON-INFRINGEMENT OF THIRD PARTY INTELLECTUAL PROPERTY RIGHTS (AND THEIR EQUIVALENTS UNDER THE LAWS OF ANY JURISDICTION).
2. The Information contained herein is for informational purpose only and is provided only to illustrate the operation of Diodes' products described herein and application examples. Diodes does not assume any liability arising out of the application or use of this document or any product described herein. This document is intended for skilled and technically trained engineering customers and users who design with Diodes' products. Diodes' products may be used to facilitate safety-related applications; however, in all instances customers and users are responsible for (a) selecting the appropriate Diodes products for their applications, (b) evaluating the suitability of Diodes' products for their intended applications, (c) ensuring their applications, which incorporate Diodes' products, comply the applicable legal and regulatory requirements as well as safety and functional-safety related standards, and (d) ensuring they design with appropriate safeguards (including testing, validation, quality control techniques, redundancy, malfunction prevention, and appropriate treatment for aging degradation) to minimize the risks associated with their applications.
3. Diodes assumes no liability for any application-related information, support, assistance or feedback that may be provided by Diodes from time to time. Any customer or user of this document or products described herein will assume all risks and liabilities associated with such use, and will hold Diodes and all companies whose products are represented herein or on Diodes' websites, harmless against all damages and liabilities.
4. Products described herein may be covered by one or more United States, international or foreign patents and pending patent applications. Product names and markings noted herein may also be covered by one or more United States, international or foreign trademarks and trademark applications. Diodes does not convey any license under any of its intellectual property rights or the rights of any third parties (including third parties whose products and services may be described in this document or on Diodes' website) under this document.
5. Diodes' products are provided subject to Diodes' Standard Terms and Conditions of Sale (<https://www.diodes.com/about/company/terms-and-conditions/terms-and-conditions-of-sales/>) or other applicable terms. This document does not alter or expand the applicable warranties provided by Diodes. Diodes does not warrant or accept any liability whatsoever in respect of any products purchased through unauthorized sales channel.
6. Diodes' products and technology may not be used for or incorporated into any products or systems whose manufacture, use or sale is prohibited under any applicable laws and regulations. Should customers or users use Diodes' products in contravention of any applicable laws or regulations, or for any unintended or unauthorized application, customers and users will (a) be solely responsible for any damages, losses or penalties arising in connection therewith or as a result thereof, and (b) indemnify and hold Diodes and its representatives and agents harmless against any and all claims, damages, expenses, and attorney fees arising out of, directly or indirectly, any claim relating to any noncompliance with the applicable laws and regulations, as well as any unintended or unauthorized application.
7. While efforts have been made to ensure the information contained in this document is accurate, complete and current, it may contain technical inaccuracies, omissions and typographical errors. Diodes does not warrant that information contained in this document is error-free and Diodes is under no obligation to update or otherwise correct this information. Notwithstanding the foregoing, Diodes reserves the right to make modifications, enhancements, improvements, corrections or other changes without further notice to this document and any product described herein. This document is written in English but may be translated into multiple languages for reference. Only the English version of this document is the final and determinative format released by Diodes.
8. Any unauthorized copying, modification, distribution, transmission, display or other use of this document (or any portion hereof) is prohibited. Diodes assumes no responsibility for any losses incurred by the customers or users or any third parties arising from any such unauthorized use.
9. This Notice may be periodically updated with the most recent version available at <https://www.diodes.com/about/company/terms-and-conditions/important-notice>

The Diodes logo is a registered trademark of Diodes Incorporated in the United States and other countries.
All other trademarks are the property of their respective owners.
© 2023 Diodes Incorporated. All Rights Reserved.

www.diodes.com

Looking for pricing, stock, or lifecycle information?

Click below to explore more details on WIN SOURCE:

 [View DPS1035FIA-13 on WIN SOURCE](#)

 [Diodes Incorporated](#) Information

Optimize Your Supply Chain with WIN SOURCE Solutions

-  Global Sourcing Solution
-  Obsolete Management
-  Cost Control Management
-  Shortage Management
-  Alternative Solution
-  Excess Inventory Management