



**THE DATASHEET OF
TCNT157M006R0200**



J-CAP™ Series

Highest Joules/cc Conductive Polymer Solid Electrolytic Chip Capacitors

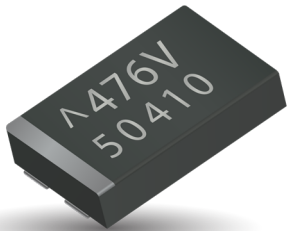

- Highest Energy per Volume
- Fast DCL Drop With Voltage Applied After Reflow
- Benign Failure Mode Under Recommended Use Conditions
- Low ESR
- Undertab Terminations Layout:
- 3x reflow cycles according to J-STD-020
- 100% Surge Current Tested

APPLICATIONS

- Power Backup for SSDs (MLC, SLC, EFD, PCIe)
- Battery-Powered Portable Equipment
- Industrial Alarms
- Smart Power Meters
- Mobile Devices

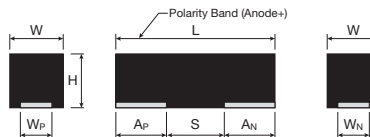

CASE DIMENSIONS UNDERTAB millimeters (inches)

Code	EIA Code	EIA Metric	L±0.20 (0.008)	W±0.20 (0.008) -0.10 (0.004)	H max.	W _p ±0.10 (0.004)	W _N ±0.10 (0.004)	A _p ±0.10 (0.004)	A _N ±0.10 (0.004)	S Min.
H	1210	3528-15	3.50 (0.138)	2.80 (0.110)	1.50 (0.059)	2.50 (0.098)	2.10 (0.083)	1.15 (0.045)	1.35 (0.053)	1.00 (0.039)
T	1210	3528-12	3.50 (0.138)	2.80 (0.110)	1.20 (0.047)	2.50 (0.098)	2.10 (0.083)	1.15 (0.045)	1.35 (0.053)	1.00 (0.039)
X	2917	7343-15	7.30 (0.287)	4.30 (0.169)	1.50 (0.059)	3.25 (0.128)	3.25 (0.128)	2.00 (0.079)	3.20 (0.126)	2.10 (0.083)
Y	2917	7343-20	7.30 (0.287)	4.30 (0.169)	2.00 (0.079)	3.25 (0.128)	3.25 (0.128)	2.00 (0.079)	3.20 (0.126)	2.10 (0.083)
Z	2917	7343-15	7.30 ± 0.30 (0.287 ± 0.012)	4.30 ± 0.30 (0.169 ± 0.012)	1.50 (0.059)	2.40 (0.094)	2.40 (0.094)	1.30 ± 0.30 (0.051 ± 0.012)	1.30 ± 0.30 (0.051 ± 0.012)	4.40 (0.173)
4	2924	7361-20	7.30 (0.287)	6.10 (0.240)	2.00 (0.079)	4.75 (0.187)	4.75 (0.187)	2.00 (0.079)	3.20 (0.126)	2.10 (0.083)
8	2924	7360-20	7.30 ± 0.30 (0.287 ± 0.012)	6.00 ± 0.30 (0.236 ± 0.012)	2.00 (0.079)	4.45 (0.175)	4.45 (0.175)	1.60 ± 0.30 (0.063 ± 0.012)	1.60 ± 0.30 (0.063 ± 0.012)	3.80 (0.150)

CASE DIMENSIONS J-LEAD millimeters (inches)

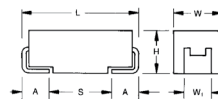

MAXIMUM ENERGY PER CASE SIZE

Code	EIA Code	EIA Metric	L±0.20 (0.008)	W±0.20 (0.008) -0.10 (0.004)	H±0.20 (0.008) -0.10 (0.004)	W ₁ ±0.20 (0.008)	A±0.30 (0.012) -0.20 (0.008)	S Min.
C	2312	6032-28	6.00 (0.236)	3.20 (0.126)	2.60 (0.102)	2.20 (0.087)	1.30 (0.051)	2.90 (0.114)
D	2917	7343-31	7.30 (0.287)	4.30 (0.169)	2.90 (0.114)	2.40 (0.094)	1.30 (0.051)	4.40 (0.173)
E	2917	7343-43	7.30 (0.287)	4.30 (0.169)	4.10 (0.162)	2.40 (0.094)	1.30 (0.051)	4.40 (0.173)
H	1210	3528-15	3.50 (0.138)	2.80 (0.110)	1.50 (0.059) max.	2.20 (0.087)	0.80 (0.031)	1.40 (0.055)
5	2917	7343-40	7.30 (0.287)	4.30 (0.169)	3.80 (0.150)	2.40 (0.094)	1.30 (0.051)	4.40 (0.173)

Case Size	H Max (mm)	Max Energy (mJ)
C	2.8	5.8
D	3.1	21.8
E	4.3	11.9
H	1.5	6.5
T	1.2	4.7
X	1.5	18.2
Y	2.0	26.4
Z	1.5	18.2
4	2.0	43.0
5	4.0	46.6
8	2.0	38.8

W₁ dimension applies to the termination width for A dimensional area only.

MARKING

C, D, E, H, T, X, Y, Z, 5 CASE

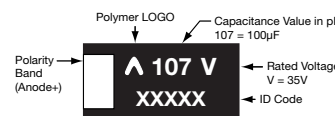
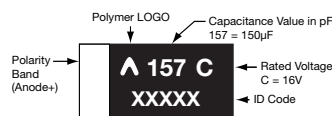

HOW TO ORDER

TCN	4	158	M	006	T	0055	E
Type TCJ TCN	Case Size See table above	Capacitance Code pF code: 1st two digits represent significant figures, 3rd digit represents multiplier	Tolerance M = ±20%	Rated DC Voltage 006 = 6.3Vdc 010 = 10Vdc 016 = 16Vdc 020 = 20Vdc 025 = 25Vdc 035 = 35Vdc	Packaging R = Pure Tin 7" Reel S = Pure Tin 13" Reel (J-Lead) A = NiPdAu 7" Reel B = NiPdAu 13" Reel A,B = only case 8 and Z	ESR in mΩ	Additional Character E = Black resin (it is possible to order PN without "E" as identical product)

Highest Joules/cc Conductive Polymer Solid Electrolytic Chip Capacitors

TECHNICAL SPECIFICATIONS

Technical Data:	All technical data relate to an ambient temperature of +25°C							
Capacitance Range:	4.7μF to 1500μF							
Capacitance Tolerance:	±20%							
Leakage Current DCL:	0.1CV							
Rated Voltage DC (VR)	≤ +85°C:	6.3	10	16	20	25	35	50
Surge Voltage (VS)	≤ +85°C:	8	13	21	26	33	46	65
Temperature Range:	-55°C up to +125°C							

NOTE: Conductive Polymer Capacitors are designed to operate within the limits of the environmental conditions specified for each series. If operated continuously at their maximum temperature and / or humidity limit, or beyond these limits, capacitors may exhibit a parametric shift in capacitance and increases in ESR. These changes may occur earlier if the specified environmental conditions are exceeded. Similarly, their normal operational time period will be significantly extended if their general duty cycle includes operation below maximum temperature within humidity controlled environments. Careful attention should be paid to maximum temperature with associated high humidity environments as well as voltage derating, ripple current and current surges. Please reference the KYOCERA AVX Conductive Polymer Capacitor Guidelines for more information or contact factory for application assistance.

CAPACITANCE AND RATED VOLTAGE RANGE (LETTER DENOTES CASE SIZE)

Capacitance		Rated Voltage DC (VR) to 85°C, [mJ]							
μF	Code	6.3V (J)	10V (A)	16V (C)	20V(D)	25V (E)	35V (V)	40V (G)	50V (T)
4.7	475						T(200) [1.8]		
6.8	685								C(200) [5.4]
10	106						T(150, 200) [3.9]		D(120) [8.0]
15	456						C(200) [5.8]		E(70) [11.9]
22	226					T(200) [4.3]	D(100) [8.5]		
33	336			H(150)/ T(200) [3.3]		H(250) [6.5]	D(70) [12.8]		
47	476		C(100)/ H(100) [1.7]	T(150) [4.7]		X(100) [9.2]	X(100,150)/ Z(100,150) [18.2]	Z(150)	
68	686	H(100) [0.8]	D(45) [2.5]	D(50) [6.7]	D(55) [8.4]	D(70) [13.3]	Y(100,150) [26.4]		
100	107		D(45) [3.6]	D(50) [9.9]	D(55) Z(100) [12.4]	D(70) 4(100) [19.6]	4(100)/ 8(100) [38.8]		
150	157	T(200) [1.7]	D(45) [5.4]	X(100) [14.9]		4(70)/ 8(70) [29.3]			
220	227	H(170) [2.6]	D(40) [7.9]	D(50) 4(70) [21.8]	4(100) [27.2]	4(100) [43.0]			
330	337	D(40) [3.8]	5(100) [11.9]	4(70) 5(100) [32.7]					
470	477	X(50) [5.4]		5(100) [46.6]					
1000	108	4(55) [11.6]							
1500	158	4(55) [17.4]							

Released ratings (ESR ratings in mOhms in parentheses) [Energy in mJ]

Engineering samples - please contact KYOCERA AVX

Note: Voltage ratings are minimum values. KYOCERA AVX reserves the right to supply higher voltage ratings in the same case size, to the same reliability standards.

J-CAP™ Series

Highest Joules/cc Conductive Polymer Solid Electrolytic Chip Capacitors



RATINGS & PART NUMBER REFERENCE

Part Number	Case Size	Capacitance (µF)	Rated Voltage (V)	Maximum Operating Temperature (°C)	DCL Max. (µA)	DF Max. (%)	ESR Max. @ 100kHz (mΩ)	1000kHz RMS Current (mA) 45°C	Product Category	MSL	ENERGY		
											Energy (mJ)	Energy/volume (mJ/cm³)	Energy/area (mJ/cm²)
6.3 Volt											6.3 Volt		
TCJH686M006#0100E	H	68	6.3	105	40.8	6	100	1000	3	3	0.8	54	8.0
TCNT157M006#0200E	T	150	6.3	105	90	10	200	700	3	4	1.7	147	17.7
TCJH227M006#0170E	H	220	6.3	105	132	10	170	800	3	3	2.6	173	26.0
TCJD337M006#0040E	D	330	6.3	105	198	6	40	2400	2	3	3.8	42	12.2
TCNX477M006#0050E	X	470	6.3	85	282	10	50	1900	5	5	5.4	115	17.3
TCN4108M006#0055E	4	1000	6.3	85	600	20	55	1860	5	4	11.6	130	26.0
TCN4158M006#0055E	4	1500	6.3	85	900	20	55	1860	5	4	17.4	195	39.0
10 Volt											10 Volt		
TCJH476M010#0100E	H	47	10	105	47	6	100	1000	3	3	1.7	115	17.3
TCJC476M010#0100E	C	47	10	125	47	6	100	1300	1	3	1.7	34	8.8
TCJD686M010#0045E	D	68	10	105	68	6	45	2200	3	3	2.5	27	7.8
TCJD107M010#0045E	D	100	10	105	100	6	45	2200	3	3	3.6	40	11.5
TCJD157M010#0045E	D	150	10	105	150	6	45	2200	3	3	5.4	59	17.2
TCJD227M010#0040E	D	220	10	105	220	6	40	2400	3	3	7.9	87	25.2
TCJ5337M010#0100E	5	330	10	105	330	10	100	1300	2	3	11.9	100	37.8
16 Volt											16 Volt		
TCJH336M016#0150E	H	33	16	105	52.8	6	150	800	3	3	3.3	223	33.4
TCNT336M016#0200E	T	33	16	105	52.8	6	200	700	3	4	3.3	277	33.4
TCNT476M016#0150E	T	47	16	105	75.2	6	150	800	3	4	4.7	395	47.6
TCJD686M016#0050E	D	68	16	105	108.8	6	50	2100	2	3	6.7	74	21.5
TCJD107M016#0050E	D	100	16	105	160	6	50	2100	2	3	9.9	109	31.6
TCNX157M016#0100E	X	150	16	105	240	6	100	1300	3	4	14.9	316	47.4
TCJD227M016#0050E	D	220	16	105	352	10	50	2100	2	3	21.8	240	69.5
TCN4227M016#0070E	4	220	16	105	352	20	70	1650	2	4	21.8	245	49.0
TCN4337M016#0070E	4	330	16	105	528	20	70	1650	3	4	32.7	367	73.5
TCJ5337M016#0100E	5	330	16	105	528	10	100	1300	2	3	32.7	274	104.2
TCJ5477M016#0100E	5	470	16	105	752	10	100	1300	3	3	46.6	391	148.5
20 Volt											20 Volt		
TCJD686M020#0055E	D	68	20	105	136	6	55	2000	3	3	8.4	92	26.7
TCJD107M020#0055E	D	100	20	105	200	6	55	2000	3	3	12.4	136	39.3
TCNZ107M020#0100E	Z	100	20	105	200	8	100	1300	3	4	12.4	262	39.3
TCN4227M020#0100E	4	220	20	85	440	10	100	1380	5	4	27.2	305	61.1
25 Volt											25 Volt		
TCNT226M025#0200E	T	22	25	105	55	6	200	700	3	4	4.3	364	43.9
TCNH336M025#0250E	H	33	25	105	82.5	10	250	600	3	4	6.5	439	65.8
TCNX476M025#0100E	X	47	25	105	117.5	6	100	1300	2	5	9.2	195	29.3
TCJD686M025#0070E	D	68	25	105	170	6	70	1800	2	3	13.3	146	42.3
TCJD107M025#0070E	D	100	25	105	250	6	70	1800	2	3	19.6	215	62.3
TCN4107M025#0100E	4	100	25	105	250	6	100	1380	2	4	19.6	219	43.9
TCN4157M025#0070E	4	150	25	105	375	6	70	1650	2	4	29.3	329	65.9
TCN8157M025#0070E	8	150	25	105	375	8	70	1650	2	3	29.3	329	65.9
TCN4227M025#0100E	4	220	25	105	550	10	100	1380	3	4	43.0	483	96.7
35 Volt											35 Volt		
TCNT475M035#0200E	T	4.7	35	105	16.5	10	200	700	3	4	1.8	154	18.6
TCNT106M035#0150E	T	10	35	105	35	10	150	800	3	4	3.9	328	39.5
TCNT106M035#0200E	T	10	35	105	35	10	200	700	3	4	3.9	328	39.5
TCJC156M035#0200E	C	15	35	105	52.5	6	200	900	3	3	5.8	116	30.3
TCJD226M035#0100E	D	22	35	105	77	6	100	1500	2	3	8.5	94	27.1
TCJD336M035#0070E	D	33	35	105	115.5	6	70	1800	2	3	12.8	141	40.7
TCNX476M035#0100E	X	47	35	105	165	10	100	1300	3	4	18.2	387	58.0
TCNX476M035#0150E	X	47	35	105	165	10	150	1100	3	4	18.2	387	58.0
TCNZ476M035#0100E	Z	47	35	105	165	10	100	1300	3	4	18.2	387	58.0
TCNZ476M035#0150E	Z	47	35	105	165	10	150	1100	3	4	18.2	387	58.0
TCNY686M035#0100E	Y	68	35	105	238	10	100	1400	3	4	26.4	420	83.9
TCNY686M035#0150E	Y	68	35	105	238	10	150	1100	3	4	26.4	420	83.9
TCN4107M035#0100E	4	100	35	105	350	10	100	1380	2	3	38.8	435	87.1
TCN8107M035#0100E	8	100	35	105	350	10	100	1380	2	3	38.8	435	87.1
40 Volt											40 Volt		
TCNZ476M040#0150E	Z	47	40	105	188	10	150	1100	3	4	23.9	506	76
50 Volt											50 Volt		
TCJC685M050#0200E	C	6.8	50	105	34	8	200	900	3	3	5.4	108	28.2
TCJD106M050#0120E	D	10	50	105	50	10	120	1400	3	3	8.0	87	25.3
TCJE156M050#0070E	E	15	50	105	75	6	70	1900	3	3	11.9	93	38.0

Energy is calculated by this formula (consider derating factor):

$$\text{Energy} = \frac{1}{2} C \times ((V_r \times X)^2 - V_x^2)$$

where C = Capacitance

V_r = Rated Voltage

X = Recommended derating factor

V_x = 3V (invariable)

Moisture Sensitivity Level (MSL) is defined according to J-STD-020. All technical data relates to an ambient temperature of +25°C. Capacitance is measured at 120Hz, 0.5RMS with DC bias of 2.2 volts. DCL is measured at rated voltage after 5 minutes. ESR allowed to move up to 1.25 times catalog limit post mounting. For typical weight and composition see page 253.

NOTE: KYOCERA AVX reserves the right to supply higher voltage ratings in the same case size, to the same reliability standards.

J-CAP™ Series

Highest Joules/cc Conductive Polymer Solid Electrolytic Chip Capacitors

ESR allowed to move up to 1.25 times catalogue limit post mounting.
 For typical weightand composition, see page 125

RECOMMENDED DERATING FACTOR

Voltage and temperature derating as percentage of Vr

Product Category 1

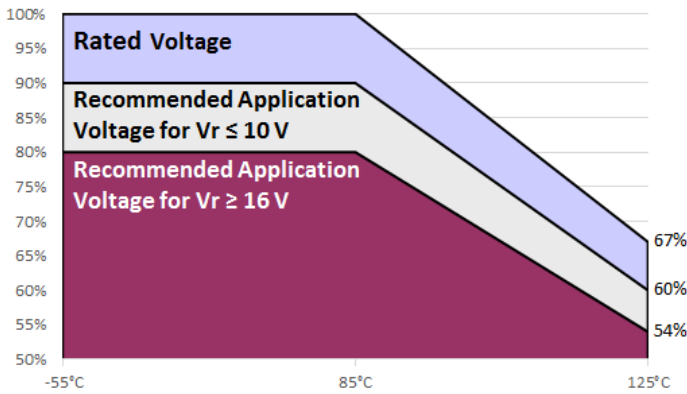

Product Category 2

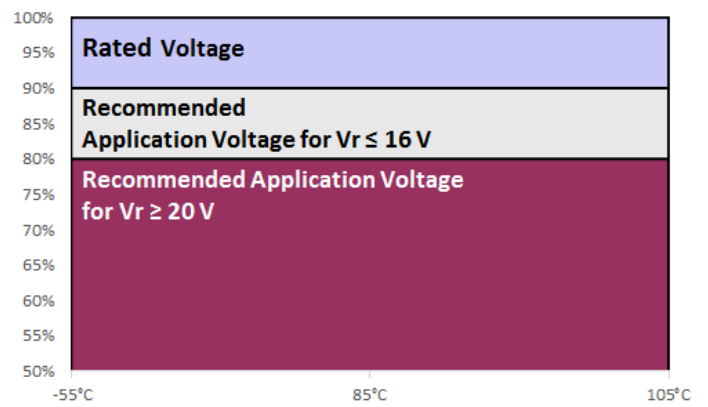

Product Category 3

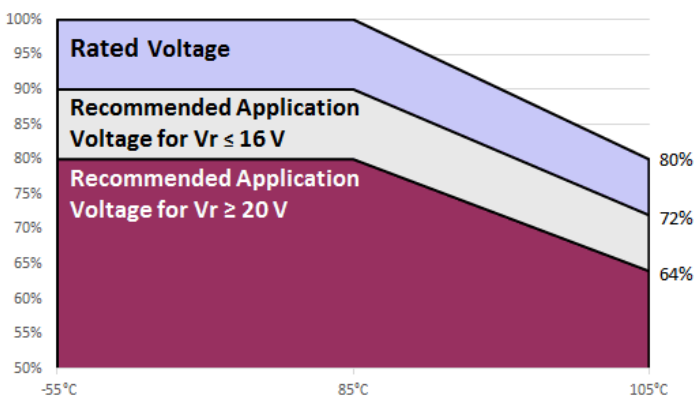

Product Category 5

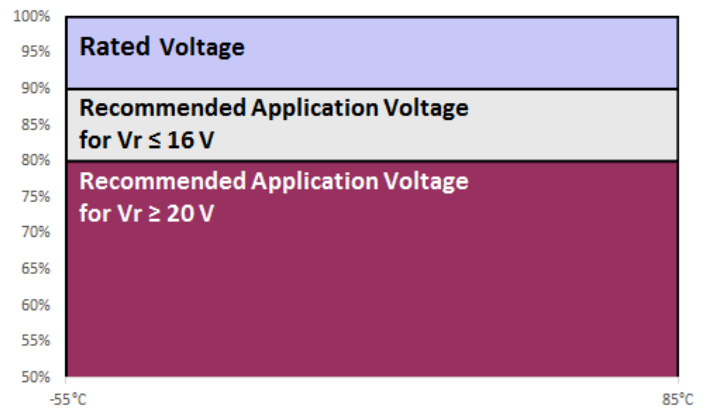

J-CAP™ Series

Highest Joules/cc Conductive Polymer Solid Electrolytic Chip Capacitors



PRODUCT CATEGORY 1 (TEMPERATURE RANGE -55°C TO +125°C)

TEST	Condition	Characteristics								
Endurance	Apply rated voltage (Ur) at 85°C and /or 2/3 rated voltage (Ur) at 125°C for 2000 hours through a circuit impedance of $\leq 0.1\Omega/V$. Stabilize at room temperature for 1-2 hours before measuring.	Visual examination	no visible damage							
		DCL	1.25 x initial limit							
		$\Delta C/C$	within $\pm 20\%$ of initial value							
		DF	1.5 x initial limit							
		ESR	2 x initial limit							
Storage Life	Store at 125°C, no voltage applied, for 2000 hours. Stabilize at room temperature for 1-2 hours before measuring.	Visual examination	no visible damage							
		DCL	2 x initial limit							
		$\Delta C/C$	within $\pm 20\%$ of initial value							
		DF	1.5 x initial limit							
		ESR	2 x initial limit							
Humidity	Store at 65°C and 95% relative humidity for 500 hours, with no applied voltage. Stabilize at room temperature and humidity for 1-2 hours before measuring.	Visual examination	no visible damage							
		DCL	3 x initial limit							
		$\Delta C/C$	within +30/-20% of initial value							
		DF	1.5 x initial limit							
		ESR	2 x initial limit							
Temperature Stability	Step	Temperature°C	Duration(min)		+20°C	-55°C	+20°C	+85°C	+125°C	+20°C
	1	+20	15							
	2	-55	15	DCL	IL*	n/a	IL*	10 x IL*	12.5 x IL*	IL*
	3	+20	15	$\Delta C/C$	n/a	+0/-20%	$\pm 5\%$	+20/-0%	+30/-0%	$\pm 5\%$
	4	+85	15	DF	IL*	1.5 x IL*	IL*	1.5 x IL*	2 x IL*	IL*
	5	+125	15							
	6	+20	15							
Surge Voltage	Apply 1.3x 0.67x rated voltage (Ur) at 125°C for 1000 cycles of duration 6 min (30 sec charge, 5 min 30 sec discharge) through a charge / discharge resistance of 1000 Ω	Visual examination	no visible damage							
		DCL	initial limit							
		$\Delta C/C$	within +10/-20% of initial value for Vr $\leq 10V$ within +20/-30% of initial value for Vr $\geq 16V$							
		DF	1.25 x initial limit							
Mechanical Shock	MIL-STD-202, Method 213, Condition C	Visual examination	no visible damage							
		DCL	initial limit							
		$\Delta C/C$	within $\pm 5\%$ of initial value							
		DF	initial limit							
		ESR	1.25 x initial limit							
Vibration	MIL-STD-202, Method 204, Condition D	Visual examination	no visible damage							
		DCL	initial limit							
		$\Delta C/C$	within $\pm 5\%$ of initial value							
		DF	initial limit							
		ESR	1.25 x initial limit							

*Initial Limit

Initial measurement max. 1hr after the removal from dry pack or after pretreatment at 85°C for 24 hours.

PRODUCT CATEGORY 2, 3 (TEMPERATURE RANGE -55°C TO +105°C)

TEST	Condition	Characteristics								
Endurance	Apply rated voltage (Ur) at 85°C for 2000 hours through a circuit impedance of $\leq 0.1\Omega/V$ (all CATEGORIES). And / or apply rated voltage (Ur) (CATEGORY 2) or 0.8x rated voltage (CATEGORY 3) at 105°C for 2000 hours through a circuit impedance of $\leq 0.1\Omega/V$. Always stabilize at room temperature for 1-2 hours before measuring.	Visual examination	no visible damage							
		DCL	1.25 x initial limit							
		$\Delta C/C$	within +10/-20% of initial value for $V_r \leq 16V$ within $\pm 20\%$ of initial value for $V_r \geq 20V$							
		DF	1.5 x initial limit							
		ESR	2 x initial limit							
Storage Life	Store at 105°C, no voltage applied, for 2000 hours. Stabilize at room temperature for 1-2 hours before measuring.	Visual examination	no visible damage							
		DCL	1.25 x initial limit							
		$\Delta C/C$	within +10/-20% of initial value for $V_r \leq 16V$ within $\pm 20\%$ of initial value for $V_r \geq 20V$							
		DF	1.5 x initial limit							
		ESR	2 x initial limit							
Humidity	Store at 65°C and 95% relative humidity for 500 hours, with no applied voltage. Stabilize at room temperature and humidity for 1-2 hours before measuring.	Visual examination	no visible damage							
		DCL	3 x initial limit							
		$\Delta C/C$	within +30/-20% of initial value							
		DF	1.5 x initial limit							
		ESR	2 x initial limit							
Temperature Stability	Step	Temperature°C	Duration(min)							
	1	+20	15							
	2	-55	15							
	3	+20	15							
	4	+85	15							
	5	+105	15							
	6	+20	15							
				+20°C	-55°C	+20°C	+85°C	+105°C	+20°C	
				DCL	IL*	n/a	IL*	10 x IL*	12.5 x IL*	IL*
				$\Delta C/C$	n/a	+0/-20%	$\pm 5\%$	+20/-0%	+30/-0%	$\pm 5\%$
				DF	IL*	1.5 x IL*	IL*	1.5 x IL*	2 x IL*	IL*
Surge Voltage	Apply 1.3x rated voltage (Ur) at 105°C for CATEGORY 2, or apply 1.3x 0.8x rated voltage (Ur) at 105°C for CATEGORY 3 for 1000 cycles of duration 6 min (30 sec charge, 5 min 30 sec discharge) through a charge / discharge resistance of 1000 Ω	Visual examination	no visible damage							
		DCL	initial limit							
		$\Delta C/C$	within +10/-20% of initial value for $V_r \leq 16V$ within +20/-30% of initial value for $V_r \geq 20V$							
		DF	1.25 x initial limit							
		ESR	1.25 x initial limit							
Mechanical Shock	MIL-STD-202, Method 213, Condition C	Visual examination	no visible damage							
		DCL	initial limit							
		$\Delta C/C$	within $\pm 5\%$ of initial value							
		DF	initial limit							
		ESR	1.25 x initial limit							
Vibration	MIL-STD-202, Method 204, Condition D	Visual examination	no visible damage							
		DCL	initial limit							
		$\Delta C/C$	within $\pm 5\%$ of initial value							
		DF	initial limit							
		ESR	1.25 x initial limit							

*Initial Limit

Initial measurement max. 1 hr after the removal from dry pack or after pretreatment at 85°C for 24 hours.

PRODUCT CATEGORY 5 (TEMPERATURE RANGE -55°C TO +85°C)

TEST	Condition			Characteristics					
Endurance	Apply rated voltage (Ur) at 85°C for 2000 hours through a circuit impedance of $\leq 0.1\Omega/V$. Stabilize at room temperature for 1-2 hours before measuring.			Visual examination	no visible damage				
				DCL	1.25 x initial limit				
				$\Delta C/C$	within +10/-20% of initial value for Vr $\leq 16V$ within $\pm 20\%$ of initial value for Vr $\geq 20V$				
				DF	1.5 x initial limit				
				ESR	2 x initial limit				
Storage Life	Store at 85°C, no voltage applied, for 2000 hours. Stabilize at room temperature for 1-2 hours before measuring.			Visual examination	no visible damage				
				DCL	1.25 x initial limit				
				$\Delta C/C$	within +10/-20% of initial value for Vr $\leq 16V$ within $\pm 20\%$ of initial value for Vr $\geq 20V$				
				DF	1.5 x initial limit				
				ESR	2 x initial limit				
Humidity	Store at 65°C and 95% relative humidity for 500 hours, with no applied voltage. Stabilize at room temperature and humidity for 1-2 hours before measuring.			Visual examination	no visible damage				
				DCL	5 x initial limit				
				$\Delta C/C$	within +40/-20% of initial value				
				DF	1.5 x initial limit				
				ESR	2 x initial limit				
Temperature Stability	Step	Temperature°C	Duration(min)		+20°C	-55°C	+20°C	+85°C	+20°C
	1	+20	15						
	2	-55	15	DCL	IL*	n/a	IL*	10 x IL*	IL*
	3	+20	15	$\Delta C/C$	n/a	+0/-20%	$\pm 5\%$	+20/-0%	$\pm 5\%$
	4	+85	15	DF	IL*	1.5 x IL*	IL*	1.5 x IL*	IL*
	5	+20	15						
Surge Voltage	Apply 1.3x rated voltage (Ur) at 85°C for 1000 cycles of duration 6 min (30 sec charge, 5 min 30 sec discharge) through a charge / discharge resistance of 1000 Ω			Visual examination	no visible damage				
				DCL	initial limit				
				$\Delta C/C$	within +10/-20% of initial value for Vr $\leq 16V$ within +20/-30% of initial value for Vr $\geq 20V$				
				DF	1.25 x initial limit				
				ESR	2 x initial limit				
Mechanical Shock	MIL-STD-202, Method 213, Condition C			Visual examination	no visible damage				
				DCL	initial limit				
				$\Delta C/C$	within $\pm 5\%$ of initial value				
				DF	initial limit				
				ESR	1.25 x initial limit				
Vibration	MIL-STD-202, Method 204, Condition D			Visual examination	no visible damage				
				DCL	initial limit				
				$\Delta C/C$	within $\pm 5\%$ of initial value				
				DF	initial limit				
				ESR	1.25 x initial limit				

*Initial Limit

Initial measurement max. 1hr after the removal from dry pack or after pretreatment at 85°C for 24 hours.

J-CAP™ Series

Highest Joules/cc Conductive Polymer Solid Electrolytic Chip Capacitors



SOLID ELECTROLYTIC CAPACITOR ROADMAP

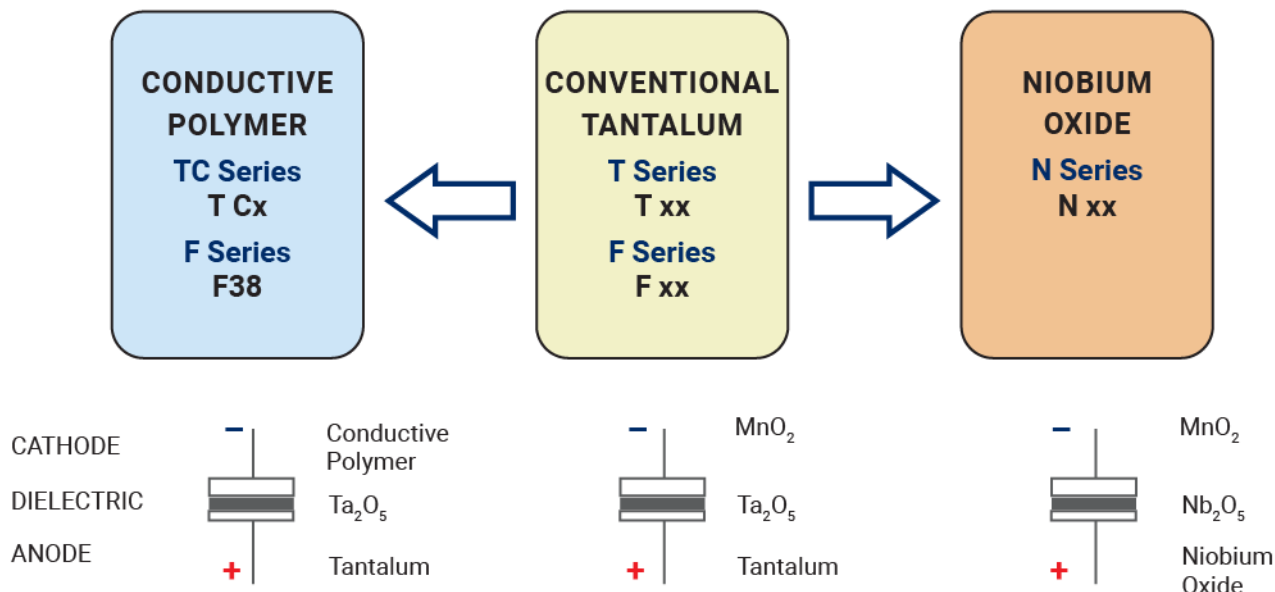

FIVE CAPACITOR CONSTRUCTION STYLES

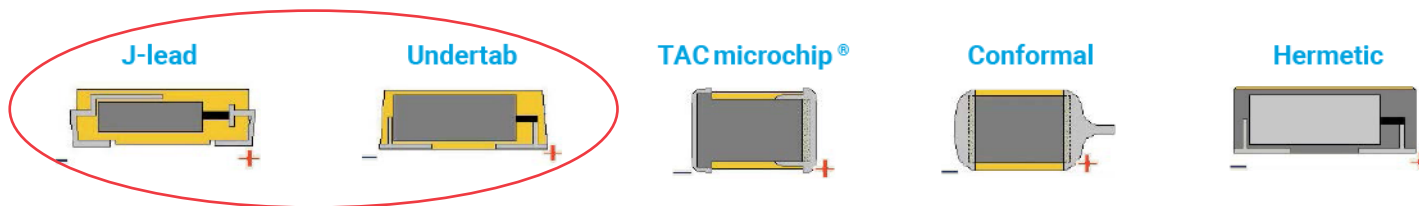

SERIES LINE UP : Conductive Polymer

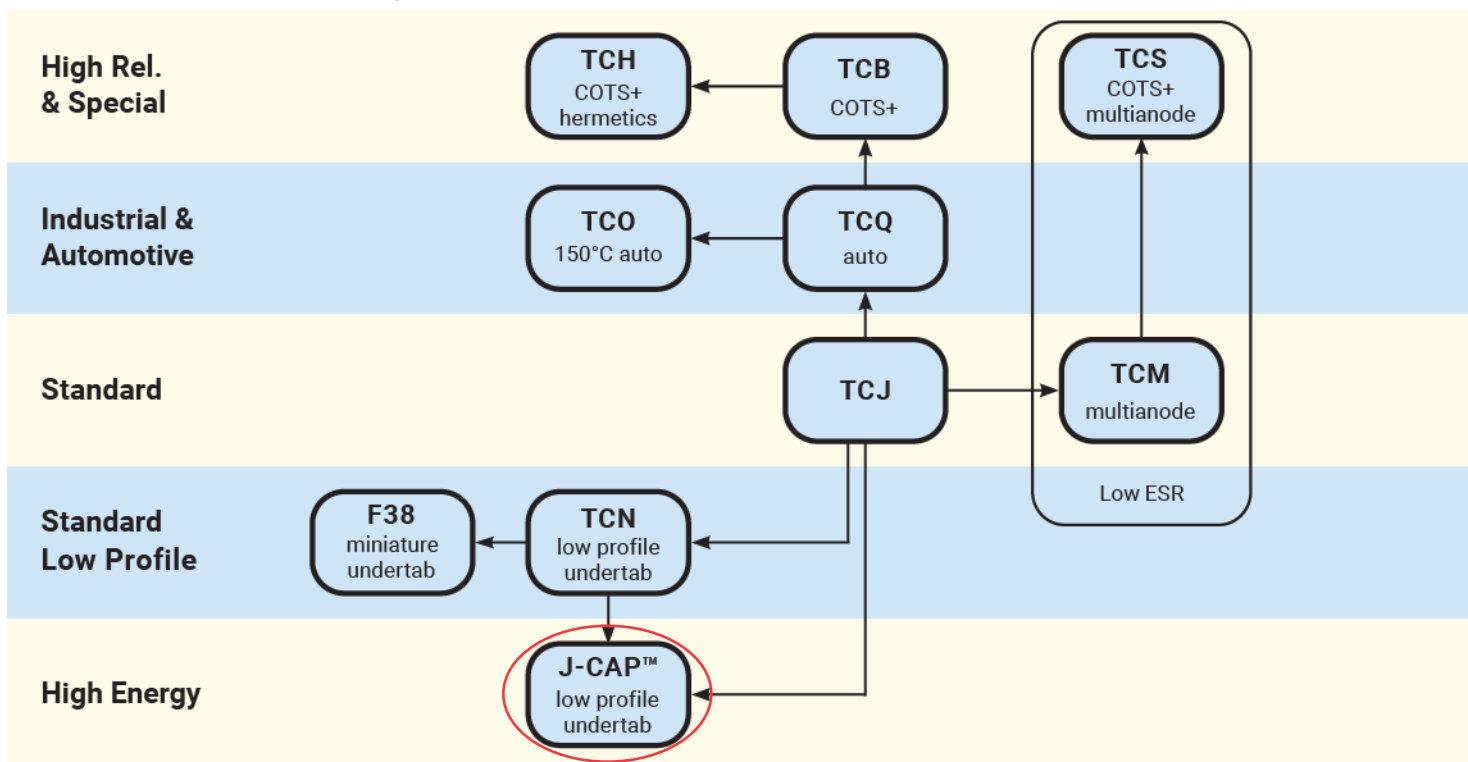

Looking for pricing, stock, or lifecycle information?

Click below to explore more details on WIN SOURCE:

- ⊖ [View TCNT157M006R0200 on WIN SOURCE](#)
- ⊖ [AVX Corp/Kyocera Corp Information](#)

Optimize Your Supply Chain with WIN SOURCE Solutions

- ✓ Global Sourcing Solution
- ✓ Obsolete Management
- ✓ Cost Control Management
- ✓ Shortage Management
- ✓ Alternative Solution
- ✓ Excess Inventory Management